

Stanislaus County Non-Motorized Transportation Plan September 2008

Prepared for
Stanislaus Council of Governments



Prepared by
Alta Planning + Design



ACKNOWLEDGEMENTS

Stanislaus County Council of Governments

Vince Harris, Executive Director
Carlos Yamzon, Senior Regional Planner
Charles Turner, Associate Planner

Steering Committee

Anthony Smith (City of Oakdale)
April Schneider (Modesto Bicycle Coalition)
Bob Ford (City of Modesto)
Curtis Jorritsma (City of Patterson)
Doug Critchfield (City of Modesto)
Emily Pino (City of Riverbank)
Ernie Garza (City of Newman)
Jim Weaver (City of Waterford)
Kevin Crane (City of Ceres)
Leisser Mazariegos (City of Ceres)
Mary Hemminger (City of Hughson)
Matt Ericikson (City of Waterford)
Phil Baird (Modesto Bicycle Coalition)
Phil Rockey (City of Oakdale)
Roger Fall (City of Turlock)
Ron Cherrier (Stanislaus County Public Works)
Stephanie Ocasio (City of Newman)

Consultants

Alta Planning + Design
Brett Hondorp, Principal
Eric Anderson, Senior Planner
Jennifer Donlon, Planner

Alta Planning + Design

2560 9th Street
Berkeley, CA 94710
voice: 510-540-5008
fax: 510-540-5039
www.altaplanning.com



Stanislaus County Non-Motorized Transportation Plan Report

Table of Contents

EXECUTIVE SUMMARY	I
1. INTRODUCTION.....	1
1.1. SETTING	1
1.2. NON-MOTORIZED TRANSPORTATION PLAN PROCESS	2
1.3. OVERVIEW OF THE PLAN STRUCTURE.....	2
1.4. BTA COMPLIANCE.....	3
2. GOALS, OBJECTIVES, AND POLICY ACTIONS	5
2.1. GOALS	5
2.2. OBJECTIVES AND ACTIONS.....	5
3. NEEDS ANALYSIS.....	9
3.1. LAND USE AND DEMAND FOR BICYCLING AND WALKING	9
3.2. MAJOR BICYCLE AND PEDESTRIAN DESTINATIONS.....	9
3.3. COMMUTER BICYCLE NEEDS.....	10
3.4. COMMUTE PATTERNS	11
3.5. STANISLAUS COUNTY BICYCLE PARKING AND END-OF-TRIP FACILITIES.....	12
3.6. COLLISION ANALYSIS	12
3.7. PUBLIC OUTREACH	19
3.8. FUTURE USAGE AND BENEFITS.....	19
4. RECOMMENDED BICYCLE FACILITIES.....	21
4.1. INTRODUCTION	21
4.2. DEVELOPING THE BICYCLE NETWORK.....	22
4.3. PRIMARY COUNTYWIDE BIKEWAY NETWORK.....	23
4.4. COUNTYWIDE BICYCLE FACILITIES.....	27
4.5. UNINCORPORATED COUNTY BICYCLE FACILITIES	32
4.6. CITY OF CERES.....	41
4.7. CITY OF HUGHSON.....	45
4.8. CITY OF MODESTO.....	48
4.9. CITY OF NEWMAN.....	59
4.10. CITY OF OAKDALE	62
4.11. CITY OF PATTERSON.....	67
4.12. CITY OF RIVERBANK.....	70
4.13. CITY OF TURLOCK.....	73
4.14. CITY OF WATERFORD	78
5. RECOMMENDED PEDESTRIAN FACILITIES.....	83
5.1. INTRODUCTION	83
5.2. DEFINITION OF PEDESTRIAN FACILITIES	83
5.3. EXISTING CONDITIONS	84

5.4.	PROPOSED COUNTYWIDE PEDESTRIAN FACILITY IMPROVEMENTS	85
5.5.	PEDESTRIAN PROJECT SHEETS	91
5.6.	CERES IMPROVEMENT PROJECT:	92
5.7.	HUGHSON IMPROVEMENT PROJECT:	94
5.8.	MODESTO IMPROVEMENT PROJECT:	96
5.9.	NEWMAN IMPROVEMENT PROJECT:	98
5.10.	OAKDALE IMPROVEMENT PROJECT:.....	100
5.11.	PATTERSON IMPROVEMENT PROJECT:	102
5.12.	RIVERBANK IMPROVEMENT PROJECT:.....	104
5.13.	TURLOCK INTERSECTION IMPROVEMENT:.....	106
5.14.	WATERFORD IMPROVEMENT PROJECT:.....	110
6.	SAFETY AND EDUCATION PROGRAMS	113
6.1.	EXISTING PROGRAMS.....	113
6.2.	PROPOSED PROGRAMS	114
7.	IMPLEMENTATION	125
7.1.	IMPLEMENTATION PROCESS	125
7.2.	HIGH PRIORITY PROJECTS	125
7.3.	COST ESTIMATES	127
7.4.	FUNDING RESOURCES	128
	APPENDIX A: BIKEWAY DESIGN GUIDELINES.....	135
	APPENDIX B: PEDESTRIAN DESIGN GUIDELINES	155
	APPENDIX C: SAMPLE BICYCLE PARKING CODE	191
	APPENDIX D: SAMPLE CANAL USE AGREEMENT	199

Index of Tables

Table 1-1: Caltrans BTA Requirements.....	3
Table 3-1: Major Employers in Stanislaus County	9
Table 3-2: Journey to Work Data	11
Table 3-3: Travel Time to Work Data	11
Table 3-4: Future Bicycle Commute and Air Quality Projections.....	20
Table 4-1: Primary Countywide Bikeway Network.....	23
Table 4-2: Recommended Countywide Bikeway Network.....	35
Table 4-3: Ceres Existing and Proposed Bikeway Network	42
Table 4-4: Hughson Existing and Proposed Bikeway Network.....	46
Table 4-5: Modesto Existing and Proposed Bikeway Network	50
Table 4-6: Newman Existing and Proposed Bikeway Network.....	60
Table 4-7: Oakdale Existing and Proposed Bikeway Network.....	63
Table 4-8: Patterson Existing and Proposed Bikeway Facilities	68
Table 4-9: Riverbank Existing and Proposed Bikeway Network	70
Table 4-10: Turlock Existing and Proposed Bikeway Network.....	74
Table 4-11: Waterford Existing and Proposed Bikeway Network.....	79
Table 6-1: Bicycle Safety Education Programs.....	113
Table 6-2: Schools Near Proposed Bikeways.....	115
Table 7-1: High Priority Projects.....	126
Table 7-2: Estimated Bicycle Facility Basic Unit Costs	127
Table 7-3: Estimated Pedestrian Improvement Basic Unit Costs.....	127
Table 7-4: Facility Cost Estimates by Jurisdiction.....	128

Index of Figures

Figure 3-1: Bicycle Collision Distribution	13
Figure 3-2: Pedestrian Collision Distribution.....	14
Figure 3-3: Bicycle Collision Map.....	15
Figure 3-4: Pedestrian Collision Map.....	17
Figure 4-1: Primary Countywide Bikeway Network	25
Figure 4-2: Stanislaus County General Plan Map.....	34
Figure 4-3: Recommended Countywide Bikeway Network.....	39
Figure 4-4: Ceres Existing and Proposed Bikeway Network.....	44
Figure 4-5: Hughson Existing and Proposed Bikeway Network.....	47
Figure 4-6: Modesto Existing and Proposed Bikeway Network	57
Figure 4-7: Newman Existing and Proposed Bikeway Network.....	61
Figure 4-8: Oakdale Existing and Proposed Bikeway Network	66
Figure 4-9: Patterson Existing and Proposed Bikeway Network	69
Figure 4-10: Riverbank Existing and Proposed Bikeway Network.....	72
Figure 4-11: Turlock Existing and Proposed Bikeway Network.....	77
Figure 4-12: Waterford Existing and Proposed Bikeway Network	81
Figure 5-1: Countywide Pedestrian Improvement Map.....	87

This page intentionally left blank

Executive Summary

The Stanislaus County Non-Motorized Transportation Plan guides the future development of bicycle and pedestrian facilities within the County. This Plan was developed with input from the Stanislaus County Bicycle and Pedestrian Advisory Committee, the Stanislaus Council of Governments, Stanislaus County, the incorporated cities, and members of the public. This Plan seeks to meet the county's needs and desires for pleasant, enjoyable and safe places to bicycle and walk. The Plan focuses on bicyclist and pedestrian needs, the county's bicycle and pedestrian network, and planning and policies related to bicycling and walking.

The overarching, long-term goal of this Plan is to provide the cultural, infrastructure and institutional support that will guide the development of a pleasant, safe, and convenient non-motorized transportation network that everyone in Stanislaus County can use for their travel and recreational needs. The Plan guides the County toward the goals of providing bikeways and trails for all residents, increasing the number of people who bike and walk for everyday needs, improving safety for bicyclists and pedestrians, and increasing public awareness and positive attitudes about biking and walking in Stanislaus County.

Purpose of the Non-Motorized Transportation Plan

The Non-Motorized Transportation Plan was developed to:

Increase Bicycle and Pedestrian Access. Expand bicycle and pedestrian facilities and access in and between neighborhoods, employment centers, shopping areas, schools, and recreational sites, in pursuit of the goal of having 20% of all trips made by walking or biking by 2020.

Increase Bicycle Use. Make the bicycle an integral part of daily life in Stanislaus County, particularly for trips of less than five miles, by implementing and maintaining a bikeway network, providing end-of-trip facilities, improving bicycle/transit integration, encouraging bicycle use, and making bicycling safer and more convenient.

Increase Pedestrian Activity. Encourage walking as a daily form of transportation in Stanislaus County by completing a pedestrian network that services short trips and transit, improving the quality of the pedestrian environment, improving the health of all citizens, and increasing safety, convenience and access opportunities for all users.

Biking and Walking in Stanislaus County Today

The existing Stanislaus County bikeway network consists of a system of over 140 miles of bikeways, including 25 miles of Class I multi-use pathways, 58 miles of Class II bicycle lanes, and 62 miles of Class III signed bicycle routes. Class I multi-use paths provides for bicycle travel on a paved right of way completely separated from any street or highway, while Class II bike lanes provide a striped and stenciled lane for one-way travel on a street or highway. Class III bike routes provide for shared use with pedestrian or motor vehicle traffic and are typically identified only by signing. More design details for Class I, II and III facility types are provided in Chapter 4 and Appendix A of the Plan.

There are many destinations and areas of bicycle and pedestrian activity within Stanislaus County. Examples of some of the major destinations include downtowns, schools, and employment centers. Approximately 0.7% of employed residents in Stanislaus County commute by bicycle. This rate is slightly higher than the national average bicycle commute mode share of 0.4%. An anecdotal survey and cursory field review revealed an overall lack of bike parking throughout the community in public areas despite many jurisdictions having some bicycle parking requirements.

Many potential bicyclists cite traffic as their main objection to riding a bicycle on urban streets. Collision data from 2002-2007 show high numbers of bicycle related collisions in Modesto, Turlock, and Ceres. The roadway types where most collisions occurred are major arterials running through the cities. Often these roadways have high traffic volumes, high traffic speeds, and narrow shoulders.

Bicyclist and Pedestrian Needs

Bicyclist Needs

The “demand” for bicycle and pedestrian facilities can be difficult to predict. Unlike automobile use, where historical trip generation studies and traffic counts allow one to estimate future “demand” for travel, bicycle and pedestrian trip generation methods are less advanced and standardized. Land use patterns can help predict demand and are important to bikeways planning because changes in land use (and particularly employment areas) will affect average commute distance, which in turn affects the attractiveness of bicycling as a commute mode.

The needs and preferences of bicyclists vary depending on the skill level of the cyclist and the type of trip the cyclist is taking. The Stanislaus County Non-Motorized Transportation Plan considers these differences in planning a system that serves all user types. Based on field observations and input provided in the public process, the most critical needs of bicyclists in Stanislaus count include direct and safe bikeways as well as programs such as “Share the Road”.

Pedestrian Needs

People walk for many reasons: traveling to work, transit or other multi-modal facilities, school, recreation and entertainment, health and exercise, shopping, social events, personal errands, appointments, and social visits. Pedestrian needs for different trip types vary. For example, a commuter may desire a well-connected direct route with efficient signal timing, while a recreational pedestrian may be more concerned about the aesthetics of the surroundings. However, all pedestrians have several needs in common, such as safety, connectivity, and accessibility. Pedestrian mobility networks should also consider persons with disabilities. The Americans with Disabilities Act (ADA) mandates that reasonable accommodation for access should be provided for those who may need such assistance.

Based on field observations and input provided in the public input process, the most critical needs of pedestrians in Stanislaus County include crossing visibility, continuous facilities, uniform design guidelines, and direct connections.

Public Outreach

Representatives from the cities as well as members of the Modesto Bicycle Coalition served on a Bicycle and Pedestrian Advisory Committee (BPAC) for this plan. They identified the following needs and concerns which have been incorporated into the projects and programs in the following chapters.

- Need for a countywide bike route network with improved roadway shoulders.
- Long-term vision of a countywide network of Canal pathways connecting communities
- Pedestrian connections across obstacles such as highways and rivers
- Pedestrian improvements to access shopping and school areas
- Need for education and outreach such as “Share the Road”
- Need for a countywide bicycle and pedestrian coordinator to liaison between agencies and help secure funding

Recommendations

The Non-Motorized Transportation Plan outlines a range of recommendations to guide Stanislaus County toward the goals of providing bikeways and trails for all Stanislaus County residents, increasing the number of people who bike and walk for everyday needs, improving safety for bicyclists and pedestrians, and increasing public awareness and positive attitudes about biking and walking in Stanislaus County. Recommendations were developed to reflect public input, existing conditions, and future plans. The recommendations include bicycle and pedestrian infrastructure improvements, safety and education programs, funding and implementation strategies, and design and policy recommendations. These recommendations are outlined below.

Bicycle Infrastructure Improvements

The recommended bicycle facilities are intended to fill in gaps within the current bicycle network, to continue the expansion of the existing network, to formalize existing routes used by cyclists, and to improve access between residential neighborhoods and the current bikeway network. A key recommended project is the Primary Countywide Bikeway Network. The Primary Bikeway Network is a concept that includes the 134 miles of bikeway corridors for connecting the cities within the County. Most are in the unincorporated areas. In addition to the Primary Countywide Bikeway Network, intra-city bikeways are recommended. These bikeways will connect residential areas of Stanislaus County with schools, parks, community centers, downtowns, and other destinations. The Plan is focused around a countywide system of bicycle routes with local bike lanes, pathways and routes in each community.

Pedestrian Infrastructure Improvements

The recommended pedestrian infrastructure improvements are intended to enhance pedestrian access and circulation as well as help pedestrians feel more comfortable when walking in Stanislaus County. A number of recommendations are made for infrastructure projects that should be implemented on a broad countywide basis. These projects were divided into several categories of improvements: Sidewalk Gaps, Curb Ramps, Signalized Intersections, Signal Timing, and Unsignalized Intersections. Following the Countywide project recommendations, a number of example project recommendations are identified. These projects seek to improve specific intersections, corridors, or other locations that were identified through the existing conditions and public input process as needed improvement areas.

Safety and Education Programs

In addition to the recommended bicycle and pedestrian facilities, the Plan recommends specific programs and policies intended to facilitate planning and designing for bicyclists and pedestrians. The recommendations include events and incentives to encourage people to bike and walk, education programs to teach students and adults bicycle safety, and outreach programs to promote safer interactions between drivers, bicyclists and pedestrians. Policy recommendations focus on modifications and additions that would support the development of a Countywide non-motorized transportation network and would encourage people to bike and walk more. Recommended programs include:

- Safe Routes to Schools
- Adult Bicycle Education
- Share the Road Outreach
- Earn-a-Bike Program
- Bike-to-Work and Bike-to-School Days
- Sidewalk Stroll Events
- Walking Tours

Funding and Implementing the Plan

Project Prioritization

Once a bikeway system has been identified, the greatest challenge is to identify the top priority projects that will offer the greatest benefit to bicyclists if implemented. Prioritization involves a number of factors, including: (a) cost and construction feasibility given existing traffic, safety, and environmental constraints; (b) needs, benefit, and public support; (c) funding cycles and opportunities, and strength of the project as measured by specific funding criteria.

During the BPAC (Bicycle and Pedestrian Advisory Committee) Workshop #2, held in August 2008 to present the Draft Non-Motorized Transportation Plan, the BPAC members provided input on prioritizing the list of projects discussed in Chapter 4. Based on that input, those projects that were prioritized highest include those in the Countywide Primary Bikeway Network.

High Priority Projects

Segment Number	From	To	Bikeway Class	Length (Miles)
1	Patterson City Limits	Newman City Limits	Class I	10.33
2A	Crows Landing Rd.	W Bradbury Rd.	Class I	4.75
2A	W Bradbury Rd.	Crows Landing Rd.	Class I	0.74
2A	Turlock City Limits	Crows Landing Rd.	Class I	5.05
2B	SR 33	Prairie Flower Drain	Class II	5.37
3	TID Lateral No 4	Moore Rd.	Class I	5.76
4	Moore Rd.	Tully Rd.	Class I	3.80
5	Ceres Main	Turlock City Limits	Class I	3.82
6	S Santa Fe Ave.	Faith Home Rd.	Class I	1.99
7	E Hatch Rd.	Yosemite Blv.	Class I	2.40
8	Tuolumne River	S Santa Fe Ave.	Class I	2.95
8	Geer Rd.	MID Main	Class I	3.33
8	Tuolumne River	MID Lateral No 1	Class I	0.75
9	Dry Creek	Albers Rd.	Class I	4.77
9	Albers Rd.	Waterford City Limits	Class I	4.11
10	Riverbank City Limits	Albers Rd.	Class I	8.12
11	Riverbank City Limits	Oakdale City Limits	Class I	2.40
12	Claus Rd.	Oakdale City Limits	Class II	2.60
13	Oakdale City Limits	Waterford City Limits	Class III	7.33
14B	Turlock City Limits	S Santa Fe Ave.	Class II	2.66
14A	Turlock City Limits	Oakdale City Limits	Class III	14.08
15	Claus Rd.	N Eucalyptus Ave.	Class III	7.79
16A	E Service Rd.	Crows Landing Rd.	Class II	0.51
16A	E Whitmore Ave.	E Service Rd.	Class II	1.00
16A	Ceres City Limits	E Grayson Rd.	Class II	0.49
16A	SR 33	W Grayson Rd.	Class III	13.95
17	San Joaquin River	Turlock City Limits	Class III	9.90
17	Sycamore Ave.	San Joaquin River	Class III	2.01
18	Modesto City Limits	Bridgewood Wy.	Class II	0.56
18	Claribel Rd.	Modesto City Limits	Class II	0.75
18	Crawford Rd.	Claribel Rd.	Class II	0.49

It is important to remember that the lists of bikeway projects and programs are flexible concepts that serve as guidelines to those responsible for implementation. The High Priority project list, and perhaps even the overall system and segments themselves may change over time as a result of changing bicycling patterns and implementation constraints and opportunities. The Stanislaus Council of Governments, staff, and BPAC should review the High Priority project list on an annual basis to ensure that it reflects the most current priorities, needs, and opportunities for implementing the bikeway network in a logical and efficient manner, and that in particular the list takes advantage of all available funding opportunities and grant cycles. As projects are implemented and taken off the list, new projects should be moved up into High Priority status.

Cost Estimates

Construction of the recommended bicycle and pedestrian facilities will result in a total of more than 600 miles of new bikeway facilities. Pedestrian facility recommendations include improvements at nine intersections or corridors. The total cost of constructing the recommended bicycle projects is estimated at \$235 million dollars and the estimated cost of the pedestrian projects is estimated at about \$2.6 million dollars.¹

Cost Summary of Proposed Improvements

Jurisdiction	Bikeways	Pedestrian	Total
County	\$138,820,400	\$0	\$138,820,400
Ceres	\$5,473,400	\$345,200	\$5,818,600
Modesto	\$50,832,600	\$47,200	\$50,879,800
Hughson	\$151,600	\$0	\$151,600
Newman	\$3,403,400	\$121,375	\$3,524,775
Oakdale	\$10,729,900	\$356,200	\$11,086,100
Patterson	\$2,395,800	\$286,000	\$2,681,800
Riverbank	\$8,529,000	\$244,900	\$8,773,900
Turlock	\$10,683,500	\$400,300	\$11,083,800
Waterford	\$4,372,800	\$342,725	\$4,715,525
Total	\$235,392,400	\$2,143,900	\$237,536,300

Contents of the Non-Motorized Transportation Plan

The Non-Motorized Transportation Plan can be divided into three parts: Chapters 1-4, Chapters 5-8 and the Appendices. The first four chapters outline the existing bicycling and walking conditions in Stanislaus County. The last four chapters present recommendations to guide the future development of bicycling and walking in the County. The Appendices provide supporting information such as design guidelines for bicycle and pedestrian facilities, sample bicycle parking ordinance language, and a sample canal use agreement.

The Stanislaus County Non-Motorized Transportation Plan contains the following chapters:

- **Chapter 1 – Introduction:** Sets the context for the Plan including purpose and structure.
- **Chapter 2 – Goals and Objectives:** Summarizes the goals, policies, and objectives guiding the implementation of the Master Plan, incorporating previous planning efforts.

¹ Project-specific factors such as grading, landscaping, intersection modification, right-of-way acquisition, and bridge construction may increase the actual cost of construction, sometimes significantly.

- **Chapter 3 – Needs Analysis:** This chapter reviews the relationship between bicycle and pedestrian activity, commute patterns, demographics, land use and collisions.
- **Chapter 4 – Recommended Bicycle Facilities:** Outlines the existing facilities, proposed bicycle improvements, bikeways and the phasing and prioritization for bikeway projects throughout Stanislaus County.
- **Chapter 5 – Recommended Pedestrian Facilities:** Outlines the existing facilities and recommended pedestrian improvements including countywide projects and specific projects.
- **Chapter 6 – Safety and Education Programs:** Describes existing and proposed non-infrastructure improvements.
- **Chapter 7 – Implementation:** Outlines an implementation strategy, including costs estimates for proposed projects.
- **Appendix A –Bikeway Design Guidelines**
- **Appendix B –Pedestrian Design Guidelines**
- **Appendix C – Sample Bicycle Parking Code**
- **Appendix D – Sample Canal Use Agreement**

1. Introduction

The Stanislaus County Non-Motorized Transportation Master Plan (SCNTMP) was prepared by Alta Planning + Design under contract to the Stanislaus Council of Governments (StanCOG). This Non-Motorized Transportation Master Plan is a result of the diligent efforts of the Stanislaus Council of Governments, Stanislaus County, the communities of Stanislaus, other public agencies and citizens interested in improving the bicycling and pedestrian environment in the county. The Plan could not have been developed without the committed efforts of these organizations and individuals.

This Plan has been prepared as a countywide document, but is also intended to guide efforts to improve bicycling and walking conditions at the local level in the various communities of Stanislaus County. The Plan integrates the results of the County and local general plans, the regional transportation plan and previous bicycle planning efforts. The Plan also represents the County's first comprehensive pedestrian planning effort.

Why Does Stanislaus County Need a Non-Motorized Transportation Plan?

Traffic congestion is a growing problem in Stanislaus County. Managing traffic is a key strategy for the growing communities of the county to ensure they maintain their rural nature and community character. This Plan is one step in providing alternative modes and addressing future traffic congestion in the County.

In addition to traffic congestion, another reason is the enjoyment and quality of life for the residents of Stanislaus County. According to the National Sporting Good Association 2006 data, there are more bicyclists in the U.S. than skiers, golfers, and tennis players combined, so we can assume many County residents bicycle and walk at least occasionally and will benefit from this Plan. When bicycling and walking are available as daily modes of transportation or recreation, substantial health benefits result. This is especially true for the older segment of the population who benefit most from such low-impact forms of exercise.

Finally, safety concerns are one of the primary reasons to improve bicycling and walking conditions in Stanislaus County. Although the incidence of collisions involving bicycles and pedestrians may be low, concerns about safety have historically been the single greatest reason people do not commute by bicycle, as captured in polls dating back to the early 1990's (Lou Harris, 1991). Addressing those concerns for pedestrians and bicyclists through physical and program improvements is another major objective of this Plan. Collision history and analysis is provided in Chapter 3: Needs Analysis.

A key reason for preparing the Stanislaus County Non-Motorized Master Plan is to satisfy requirements of the California Bicycle Transportation Account (BTA), and other state and federal funding programs for project for which Caltrans plays an oversight and review role. Bicycle plans must be updated at a minimum of every five years. It is recommended that priority projects are reviewed on a yearly basis as conditions change.

1.1. Setting

The study area includes all of Stanislaus County. The County is in the heart of California's Central Valley and has a land area of nearly 1,500 square miles. The topography and geography of Stanislaus ranges from elevations of about 70 feet above sea level in Salida to over 3300 feet above sea level at Mount Oso.

The majority of the developed land lies in the center of the County near Route 99 in the cities of Modesto and Turlock. Most of the western and southern portions of the county are agricultural land with the exception of Patterson, Newman and unincorporated communities. The eastern portion of the County includes some incorporated cities, agricultural land, and grazing land. About 6% of the county is urbanized.

Significant portions of the county are relatively undeveloped and are host to popular recreation destinations that provide opportunities for picnicking, beach areas, boating, water sports, fishing and swimming. To the north above Oakdale is the Woodward Reservoir. Near the eastern area of the county is the Modesto Reservoir. Further south is the Turlock State Recreation Area.

There are nine incorporated cities in the County: Ceres, Hughson, Modesto, Newman, Oakdale, Patterson, Riverbank, Turlock, and Waterford. The majority of Stanislaus County's population resides in the Modesto, Turlock, and the unincorporated areas. The estimated County population in 2008 was 525,903, an 18% increase over the 2000 Census, substantially higher than the state rate of growth of 12%. Stanislaus County residents have an average per capita income of \$26,810.

The existing roadway network of Stanislaus County is built around several highways. Travel in the county is primarily by automobile due to the rural nature of the roadway network and limited opportunities for alternative modes of travel. The major north-south routes are Interstate 5 and State Routes 33 and 99. State Routes 108, 120, and 132 provide east-west travel.

The County is served by Stanislaus Regional Transit StaRT) which operates buses equipped with front bicycle racks. Stanislaus Transit serves most of the population, employment and recreation centers in the county and connects to inter-county bus service. The Modesto Area Express (MAX) also serves the area and has routes connecting with Bay Area Rapid Transit (BART) and the Altamont Commuter express rail lines. Ceres Area Transit (CAT) runs three fixed route lines in Ceres. Riverbank and Oakdale are served by the Riverbank-Oakdale Transit Authority (ROTA) with three fixed routes and Dial-A-Ride services. Bicycle racks are on every ROTA bus and trolley. The Bus Line Service of Turlock (BLAST) runs a four route system complemented by a Dial-A-Ride service. Currently bicycle parking is not available at most transit stops.

1.2. Non-Motorized Transportation Plan Process

This Plan was developed during 2007/2008 under the purview of the Stanislaus Council of Governments (StanCOG). StanCOG is the Regional Transportation Planning Agency (RTPA) for the County of Stanislaus. As part of the Plan development process, project consultants Alta Planning + Design met with each of the incorporated cities as well as Stanislaus County to collect information on existing conditions and needed improvements. StanCOG's public outreach strategy included the formation of a Bicycle and Pedestrian Advisory Committee to guide development of the plan. The BPAC consisted of representatives from each incorporated city as well as other government agencies and members of the Modesto Bicycle Coalition and other members of the public. StanCOG hosted two meetings with the BPAC.

1.3. Overview of the Plan Structure

This report is divided into sections, detailed below:

- **Chapter 1 – Introduction:** Sets the context for the Plan including purpose and structure.
- **Chapter 2 – Goals and Objectives:** Summarizes the goals, policies, and objectives guiding the implementation of the Master Plan, incorporating previous planning efforts.
- **Chapter 3 – Needs Analysis:** Reviews the relationship between bicycle and pedestrian activity, commute patterns, demographics, land use and collisions.
- **Chapter 4 – Recommended Bicycle Facilities:** Outlines the existing facilities, proposed bicycle improvements, bikeways and the phasing and prioritization for bikeway projects throughout Stanislaus County.

- **Chapter 5 – Recommended Pedestrian Facilities:** Outlines the existing facilities and recommended pedestrian improvements including countywide projects and specific projects.
- **Chapter 6 – Safety and Education Programs:** Describes existing and proposed non-infrastructure improvements.
- **Chapter 7 – Implementation:** Outlines an implementation strategy, including costs estimates for proposed projects.
- **Appendix A –Bikeway Design Guidelines**
- **Appendix B –Pedestrian Design Guidelines**
- **Appendix C – Sample Bicycle Parking Code**
- **Appendix D – Sample Canal Use Agreement**

1.4. BTA Compliance

In order to qualify for State of California Bicycle Transportation Account (BTA) funding, local bicycle plans must meet the criteria of California Streets and Highways Code Sec 891.2, detailed in **Table 1-1** below and be updated at least every five years. As of 2006, the amount of funding available to California communities through the BTA is only \$5 million statewide. Most communities will need to seek additional funding to implement the elements of their bicycle and pedestrian plans. There are no specific requirements for most other state and federal funding sources that this Plan must meet. However, having an adopted bicycle and pedestrian plan substantially improves the chances of securing funding for any project that is a part of that planning process.

Table 1-1: Caltrans BTA Requirements

Required Plan Element	Location of Element in StanCOG NMTP
(a) The estimated number of existing bicycle commuters in the plan area and the estimated increase in the number of bicycle commuters resulting from implementation of the plan.	Chapter 3 – Needs Analysis
(b) A map and description of existing and proposed land use and settlement patterns which shall include, but not be limited to, locations of residential neighborhoods, schools, shopping centers, public buildings, and major employment centers.	Chapter 4 – Recommended Bicycle Facilities
(c) A map and description of existing and proposed bikeways.	Chapter 4 – Recommended Bicycle Facilities
(d) A map and description of existing and proposed end-of-trip bicycle parking facilities. These shall include, but not be limited to, parking at schools, shopping centers, public buildings, and major employment centers.	Chapter 4 – Recommended Bicycle Facilities
(e) A map and description of existing and proposed bicycle transport and parking facilities for connections with and use of other transportation modes. These shall include, but not be limited to, parking facilities at transit stops, rail and transit terminals, ferry docks and landings, park and ride lots, and provisions for transporting bicyclists and bicycles on transit or rail vehicles or ferry vessels.	Chapter 4 – Recommended Bicycle Facilities
(f) A map and description of existing and proposed facilities for changing and storing clothes and equipment. These shall include, but not be limited to, locker, restroom, and shower facilities near bicycle parking facilities.	Chapter 4 – Recommended Bicycle Facilities

Required Plan Element	Location of Element in StanCOG NMTP
(g) A description of bicycle safety and education programs conducted in the area included within the plan, efforts by the law enforcement agency having primary traffic law enforcement responsibility in the area to enforce provisions of the Vehicle Code pertaining to bicycle operation, and the resulting effect on accidents involving bicyclists.	Chapter 6 – Safety and Education Programs
(h) A description of the extent of citizen and community involvement in development of the plan, including, but not limited to, letters of support.	Chapter 1 – Introduction
(i) A description of how the bicycle transportation plan has been coordinated and is consistent with other local or regional transportation, air quality, or energy conservation plans, including, but not limited to, programs that provide incentives for bicycle commuting.	Chapter 1 – Introduction Chapter 4 – Recommended Bicycle Facilities
(j) A description of the projects proposed in the plan and a listing of their priorities for implementation.	Chapter 4 – Recommended Bicycle Facilities Chapter 7– Implementation
(k) A description of past expenditures for bicycle facilities and future financial needs for projects that improve safety and convenience for bicycle commuters in the plan area.	Chapter 4 – Recommended Bicycle Facilities Chapter 7– Implementation

2. Goals, Objectives, and Policy Actions

The infrastructure improvements and programs that will be recommended in the Stanislaus County Non-Motorized Plan will be shaped by the Plan's goals, objectives, and policy actions. Goals provide the context for the specific objectives and policy actions discussed in the Non-Motorized Transportation Plan. The goals provide the long-term vision and serve as the foundation of the plan. Goals are broad statements of purpose that do not provide specific descriptions of the goal, while policy actions provide a bridge between general policies and actual implementation guidelines.

2.1. Goals

Goal 1: Increased Bicycle and Pedestrian Access

Expand bicycle and pedestrian facilities and access in and between neighborhoods, employment centers, shopping areas, schools, and recreational sites, in pursuit of the goal of having 20% of all trips made by walking or biking by 2020.

Goal 2: Increased Bicycle Transportation

Make the bicycle an integral part of daily life in Stanislaus County, particularly for trips of less than five miles, by implementing and maintaining a bikeway network, providing end-of-trip facilities, improving bicycle/transit integration, encouraging bicycle use, and making bicycling safer and more convenient.

Goal 3: Increased Pedestrian Transportation

Encourage walking as a daily form of transportation in Stanislaus County by completing a pedestrian network that services short trips and transit, improving the quality of the pedestrian environment, improving the health of all citizens, and increasing safety, convenience and access opportunities for all users.

2.2. Objectives and Actions

Objective A

Implement the Non-Motorized Transportation Plan, which identifies existing and future needs, and provides specific recommendations for facilities and programs over the next 20 years.

Objective A Policy Actions:

- Fund a countywide bicycle/pedestrian coordinator who would help implement the county and local bicycle and pedestrian improvements.
- Update the Plan periodically as required by Caltrans to reflect new policies and/or requirements for bicycle and pedestrian funding.
- Maximize coordination between all municipalities, schools, and community organizations to review and comment on bicycle and pedestrian issues of mutual concern.
- Implement the recommendation to regularly monitor bicycle- and pedestrian-related accident levels, and seek a reduction in these accident levels on a per capita basis over the next twenty years.

Objective B

Complete a continuous network of bikeways that are feasible, fundable, and that serve bicyclists' needs, especially for travel to employment centers, schools, commercial districts, transit stations, and institutions.

Objective B Policy Actions:

- Seek funding for bikeway projects through current local, regional, state, and federal funding programs and encourage multi-jurisdictional funding applications.
- Implement high priority projects as identified in this plan.
- Develop a "Complete Streets" policy to encourage construction of bikeways as a part of any roadway project, where feasible and appropriate.
- Provide opportunities for bicycling for recreational purposes, especially to access parks and open space.

Objective C

Complete a network of walkways that serves pedestrian needs, especially for short trips to employment centers, schools, commercial districts, transit stations, and institutions.

Objective C Policy Actions

- Complete missing connections to make direct routes for walking.
- Identify and mitigate impediments and obstacles to walking to school.
- Develop a "Complete Streets" policy to encourage construction of bikeways as a part of any roadway project, where feasible and appropriate.
- Work with transit authorities to ensure that pedestrian concerns are addressed in the design of transit stops.
- Provide opportunities for walking for recreational purposes.

Objective D

Include bikeway facilities in all appropriate future and development projects to facilitate on-site circulation for bicycle travel, on-site bicycle parking, and connections to the proposed system.

Objective D Policy Actions:

- Require future development to construct bikeways included in the proposed system as a condition of development.
- Encourage future commercial development to provide bicycle access to surrounding residential areas.
- Require future commercial development to place bike racks near entrances for employees and customers.
- Meet the requirements of the Americans with Disabilities Act when constructing facilities contained in the proposed system, where applicable.
- Encourage future development to consider schools as important destinations for bicyclists when designing circulation systems within new developments.

Objective E

Provide secure short- and long-term bicycle parking in employment and commercial areas, in multifamily housing, at schools, and at transit facilities, including covered and/or attended parking.

Objective E Policy Actions:

- Develop a bicycle parking policy to encourage the inclusion of bicycle parking in new development projects.
- Encourage the installation of short- and long-term bicycle parking in the public right-of-way.
- Encourage the installation of short- and long-term bicycle parking at local elementary, middle, and high schools to promote bicycle commuting and to assist in purchasing and siting long- and short-term bicycle parking.

Objective F

Increase the number of bicycle-transit trips and pedestrian access to transit.

Objective F Policy Actions:

- Support and promote bicycle access to, and parking at, transit services in Stanislaus County.
- Assist transit providers in providing and promoting secure, covered bicycle racks and lockers in the transit system to encourage bicycle use.
- Encourage bike rental opportunities near major transit terminals, key recreation destinations, and other locations where visitors are entering Stanislaus County.
- Require that any future transit service in Stanislaus County provide adequate bicycle and pedestrian access, bus mounted bicycle racks, and secure bike parking.
- Support and promote transit facility enhancements, such as bus stop access improvements, that will encourage increased bicycle and pedestrian access to transit.
- Conduct bicycle and pedestrian counts at regular intervals to evaluate usage and demand and assist in prioritization of project funding.

Objective G

Develop and implement education and encouragement plans aimed at youth, adult cyclists, pedestrians, and motorists. Increase public awareness of the benefits of bicycling and walking and of available resources and facilities.

Objective G Policy Actions

- Develop adult and youth bicycle and pedestrian education, encouragement and safety programs.
- Market the health benefits of walking and bicycling.

This page intentionally left blank

3. Needs Analysis

3.1. Land Use and Demand for Bicycling and Walking

The “demand” for bicycle and pedestrian facilities can be difficult to predict. Unlike automobile use, where historical trip generation studies and traffic counts allow one to estimate future “demand” for travel, bicycle and pedestrian trip generation methods are less advanced and standardized. Land use patterns can help predict demand and are important to bikeways planning because changes in land use (and particularly employment areas) will affect average commute distance, which in turn affects the attractiveness of bicycling as a commute mode.

The Stanislaus walkways and bikeways network will connect the neighborhoods where people live to the places they work, shop, engage in recreation, or go to school. An emphasis will be placed on regional bikeways and transit connections centered on the major activity centers, including:

- Downtown commercial districts
- Civic buildings such as Town Halls and libraries
- Schools
- Transit
- Neighborhood parks and regional recreational areas
- Employment centers

3.2. Major Bicycle and Pedestrian Destinations

There are many destinations and areas of bicycle and pedestrian activity within Stanislaus County. Examples of some of the major destinations include downtowns, schools, and employment centers. Improvements to these areas are detailed in Chapters 5 and 6. **Table 3-1** lists major employers within Stanislaus County.

*Table 3-1: Major Employers in Stanislaus County**

Rank	Company	Address	City/Town	Employees
1	Stanislaus County	(several office locations)	Modesto	4,764
2	Modesto City Schools		Modesto	3,345
3	E&J Gallo Winery		Modesto	3,311
4	Memorial Medical Center	1700 Coffee Rd,	Modesto	2,700
5	Del Monte Foods	4000 Yosemite Blvd,	Modesto	2,600
6	Modesto Junior College	435 College Ave,	Modesto	2,550
7	Signature Fruit Company	2260 Tenaya Dr,	Modesto	2,321
8	Stanislaus Food Products	1202 D St,	Modesto	2,000
9	Doctors Medical Center	1441 Florida Ave	Modesto	1,967
10	Turlock Unified School District	1574 E Canal Dr	Turlock	1,703
11	City of Modesto	1010 10th St # 6200,	Modesto	1,700
12	Foster Poultry Farms	520 C St,	Turlock	1,512
13	Emanuel Medical Center	825 Delbon Ave,	Turlock	1,500

Rank	Company	Address	City/Town	Employees
14	Save Mart Supermarkets	Multiple locations	Corporate office in Modesto	1,450
15	Ceres Unified School District	2320 Central Ave	Ceres	1,394
16	Wal-Mart	Multiple locations		1,244
17	ConAgra	705 E Whitmore Ave, Modesto 554 S Yosemite Ave, Oakdale	Modesto and Oakdale	1,000

Source: Stanislaus Economic Development & Workforce Alliance, www.stanalliance.com/facts/primaryindustries.shtml

* Reflects peak seasonal levels where applicable.

3.3. Commuter Bicycle Needs

An April 2003 national survey conducted by America Bikes showed that Americans want to bicycle more and support building infrastructure to achieve this: "Over half of Americans (52%) want to bike more than they do now and a majority of the public (53%) favors increasing federal spending to build more bike paths for easier and safer bicycling." This suggests that there is a large reservoir of potential cyclists who do not ride (or do not ride more) due to a lack of appropriate facilities.

As the bicycle element of this Plan is primarily focused on commuting cyclists—those riding to work or school, or for shopping, errands, and other utilitarian trips—it is important to understand the specific needs of bicycle commuters.

Commuter bicyclists in Stanislaus County range from employees who ride to work to a child who rides to school to people riding for shopping or other errands. Bicycling requires shorter commutes, typically less than three miles, which runs counter to most land use and transportation planning policies of the last 50-60 years that have encouraged people to live farther and farther from where they work. Access to transit helps extend the commute range of cyclists, but transit systems also face an increasingly dispersed live-work pattern that is difficult to serve. Despite these facts, Stanislaus County has a great potential to increase the number of people who ride to work or school because of (a) the small size of many of the cities, (b) moderate density residential neighborhoods near some of the county's top employment centers, (c) a favorable climate, and (d) a high percentage of work trips that are less than 15 minutes.

Commuters typically seek the most direct and fastest route available, with regular adult commuters often preferring to ride on arterials, especially those with bike lanes or wide curb lanes, rather than side streets or off-street facilities. Commuters generally prefer routes where they are required to stop as few times as possible, thereby minimizing delay. Commute periods typically coincide with peak traffic volumes and congestion, increasing the exposure to potential conflicts with vehicles. Places to safely store bicycles are of paramount importance to all bicycle commuters.

Other major commuter concerns include traffic congestion, changes in weather (rain), riding in darkness, personal safety and security.

Many younger students (ages seven to 11) use sidewalks for riding to schools or parks, which is acceptable in areas where pedestrian volumes are low and driveway visibility is high. Where on-street parking and/or landscaping obscures visibility, sidewalk riders may be exposed to a higher incidence of accidents. Older students (12 years or older) who consistently ride at speeds over 10 miles per hour (mph) should be directed to riding on-street wherever possible. Students riding the wrong-way on-street are common and account for the greatest number of recorded accidents in California, pointing to the need for safety education.

3.4. Commute Patterns

A central focus of presenting commute information is to consider the current “mode split” of people that live and work in Stanislaus County. Mode split refers to the choice of transportation a person selects to move to destinations, be it walking, bicycling, taking a bus, or driving. One major objective of any bicycle facility improvement is to increase the “split” or percentage of people who choose to bike or walk rather than drive or be driven. Every saved vehicle trip or vehicle mile represents quantifiable reductions in air pollution and can help in lessening traffic congestion.

As shown in **Table 3-2**, journey to work and travel time to work data were obtained from the 2000 U.S. Census for Stanislaus County as a whole, and compared to California and the United States.

Table 3-2: Journey to Work Data

Mode	Stanislaus County	California	United States
Bicycle	0.7%	0.8%	0.4%
Drove Alone	76.9%	71.8%	75.7%
Carpool	15.0%	14.6%	12.2%
Public Transit	15%	5.1%	4.7%
Walked	2.4%	2.9%	2.9%
Other	4.0%	4.8%	4.1%

Source: U.S. Census 2000

As shown, approximately 0.7% of employed residents in Stanislaus County commute by bicycle. This rate is slightly higher than the national average bicycle commute mode share of 0.4%, but slightly lower than the California average bicycle mode share of 0.8%. The bicycling commute rate in Stanislaus County is in contrast with level of drive-alone commuters (76.9%) that is higher than both the United States and California averages

Travel time is important because it can give an indication of the number of potential new bicycle commuters. Travel time to work is shown in **Table 3-3**.

Table 3-3: Travel Time to Work Data

Travel Time to Work	Stanislaus County	California	United States
Less than 15 minutes	35.1%	25.3%	29.4%
15 to 29 minutes	34.9%	35.4%	36.1%
30 to 44 minutes	14.2%	20.9%	19.1%
45 to 59 minutes	4.7%	8.2%	7.4%
60 minutes or more	11.2%	10.1%	8.0%

Source: Census 2000

As previously noted, Census data on commuting patterns is limited and tends to underestimate the true number of cyclists in any community. First, commute trips only make up 20% of all trips, and people who bicycle to school, for recreation or for errands are not included in Census Journey to Work data. Second, Census survey forms only allow a person to choose one mode when answering. If a commuter uses more than one mode during their trip (e.g. walking or bicycling to transit) only the longest mode is recorded (in this case, transit).

3.5. Stanislaus County Bicycle Parking and End-of-Trip Facilities

An anecdotal survey and cursory field review revealed an overall lack of bike parking throughout the community in public areas despite many jurisdictions having some bicycle parking requirements. Bicyclists visiting stores, restaurants, places of employment, and community facilities are largely left to their own devices to temporarily store their bicycles. Many of the County's elementary schools provide bicycle racks but bicycle parking at high schools is not common. Stanislaus County does not have a program to offer bicycle racks for placement on the public right of way.

The level of bicycle parking use at Stanislaus County's schools is unknown at this time. Vandalism and theft are due, in part, to poor placement of bicycle racks plus inadequate locking devices and techniques used by students. A lack of adequate racks can be a result of many factors, including the absence of a zoning code requirement for school bicycle parking, a perceived lack of need in some cases, and a view on the part of some school administrators and parents that bicycle riding is a low priority and/or unsafe means of transportation.

No official shower or locker facility for bicycle commuters is known to exist in Stanislaus County. It is possible that some employers provide these facilities or that some bicycle commuters use facilities in health clubs or other establishments. At this time no standards or policies are in place that require or encourage employers to provide such facilities.

A sample copy of a comprehensive bicycle parking ordinance is located in **Appendix C**. Specific recommendations on the bicycle storage type, amount, location, and other details are provided in **Appendix A**.

3.6. Collision Analysis

Bicycle Collisions

Many potential bicyclists cite traffic as their main objection to riding a bicycle on urban streets. The County can address this by providing good bikeway facilities, particularly at intersections, where most bicycle-motor vehicle collisions occur.

However, many concerns about cycling level of danger are based on the misconception that most bicycle collisions involve an automobile. In fact, the vast majority do not involve a motor vehicle; rather, studies of hospital data have shown that the vast majority of bicycle collisions involve falls or collisions with stationary objects, other cyclists, or pedestrians. This points to the need for education of cyclists and motorists, enforcement of existing laws, and encouragement of safe cycling techniques.

Data for reported bicycle collisions in Stanislaus County were collected from the Statewide Integrated Traffic Records System (SWITRS) from January 2002 to March 2007. During this time period there was an average of 157 bicycle-motor vehicle collisions per year reported in Stanislaus County.

Collision Locations

There are a number of locations at which several collisions were reported:

- Oakdale Road and Floyd Avenue (9 collisions)
- Coffee Road and Locke Road (5 collisions)
- Coffee Road and Floyd Avenue (5 collisions)
- Briggsmore Avenue and Prescott Road (4 collisions)
- Crows Landing Road and Amador Avenue (4 collisions)
- Hatch Road and Herndon Road (4 collisions)
- Scenic Drive and Bodem Street (4 collisions)

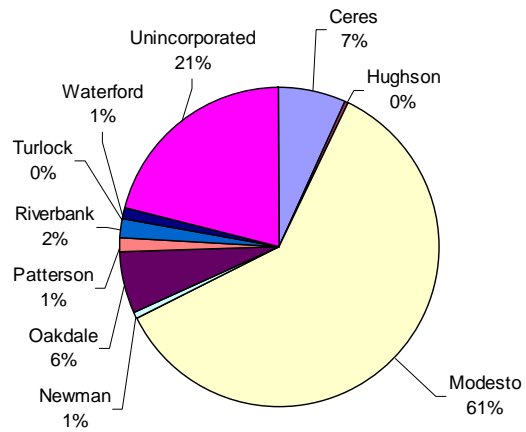

Figure 3-1: Bicycle Collision Distribution

The collision distribution by jurisdiction is shown in **Figure 3-1**.

Figure 3-3 is a countywide map of bicycle-vehicle collisions in the county. This map mirrors the information in **Figure 3-1** illustrating high numbers of collisions in Modesto, Turlock, and Ceres. The roadway types where most collisions occurred are major arterials running through the cities. Often these roadways have high traffic volumes, high traffic speeds, and narrow shoulders.

Focused Data

The more detailed Stanislaus collision data revealed that 80% of the collisions occurred on weekdays. In 47% of the collisions, motorists were considered to be at fault, with pedestrians at fault 38% of the time, and undetermined fault 15% of the time. The most common causes of collisions were pedestrians crossing at unmarked locations (42%), motorists violating the pedestrian right-of-way (24%), and a combination of improper passing and unsafe motorist travel speeds (12%). The remaining collisions were spread among a wide variety of causes.

Pedestrian Collisions

Data for reported bicycle collisions in Stanislaus County were collected from the Statewide Integrated Traffic Records System (SWITRS) from January 2002 to March 2007. During this time period there was an average of 172 pedestrian collisions per year reported in Stanislaus County.

Collision Locations

There are 16 locations with more than 2 reported collisions on Stanislaus County roads:

- Oakdale Road and Floyd Avenue (6 collisions)
- Floyd Avenue and Coffee Road (5 collisions)
- Route 132 and Wilson Avenue (5 collisions)
- 9th Street and Homser Avenue (3 collisions)

- College Avenue and Stoddard Avenue (3 collisions)
- Crows Landing Road and Glenn Avenue (3 collisions)
- Crows Landing Road and School Avenue (3 collisions)
- H Street and 18th Street (3 collisions)
- Hatch Road and Herndon Avenue Stanislaus (3 collisions)
- Mitchell Road and Fowler Road (3 collisions)
- Paradise Road and Ellen Ave Stanislaus (3 collisions)
- Route 99 and Hatch Road (3 collisions)
- Route 120 and 6th Avenue (3 collisions)
- Route 132 and Rosemore Avenue (3 collisions)
- Tully Road and Stoddard Avenue (3 collisions)
- Whitmore Avenue and Mitchell Road (3 collisions)

The pedestrian collision breakdown by location is shown in **Figure 3-2**.

Figure 3-4 is a countywide map of pedestrian collisions in the jurisdiction. This map mirrors the information in **Figure 3-2** illustrating high numbers of collisions in Modesto, the unincorporated areas of the County, and Turlock. The collisions occurred on transit routes, near schools, and on major arterials. Transit routes and areas near schools are the most likely places for pedestrian activity. Transit routes and major arterials often have high traffic volumes and speeds.

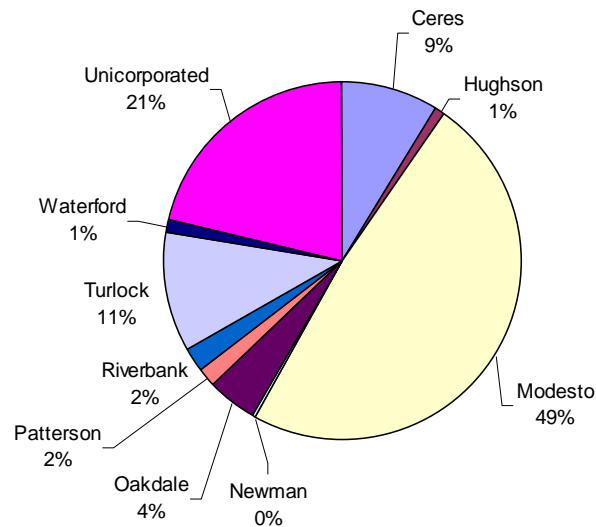
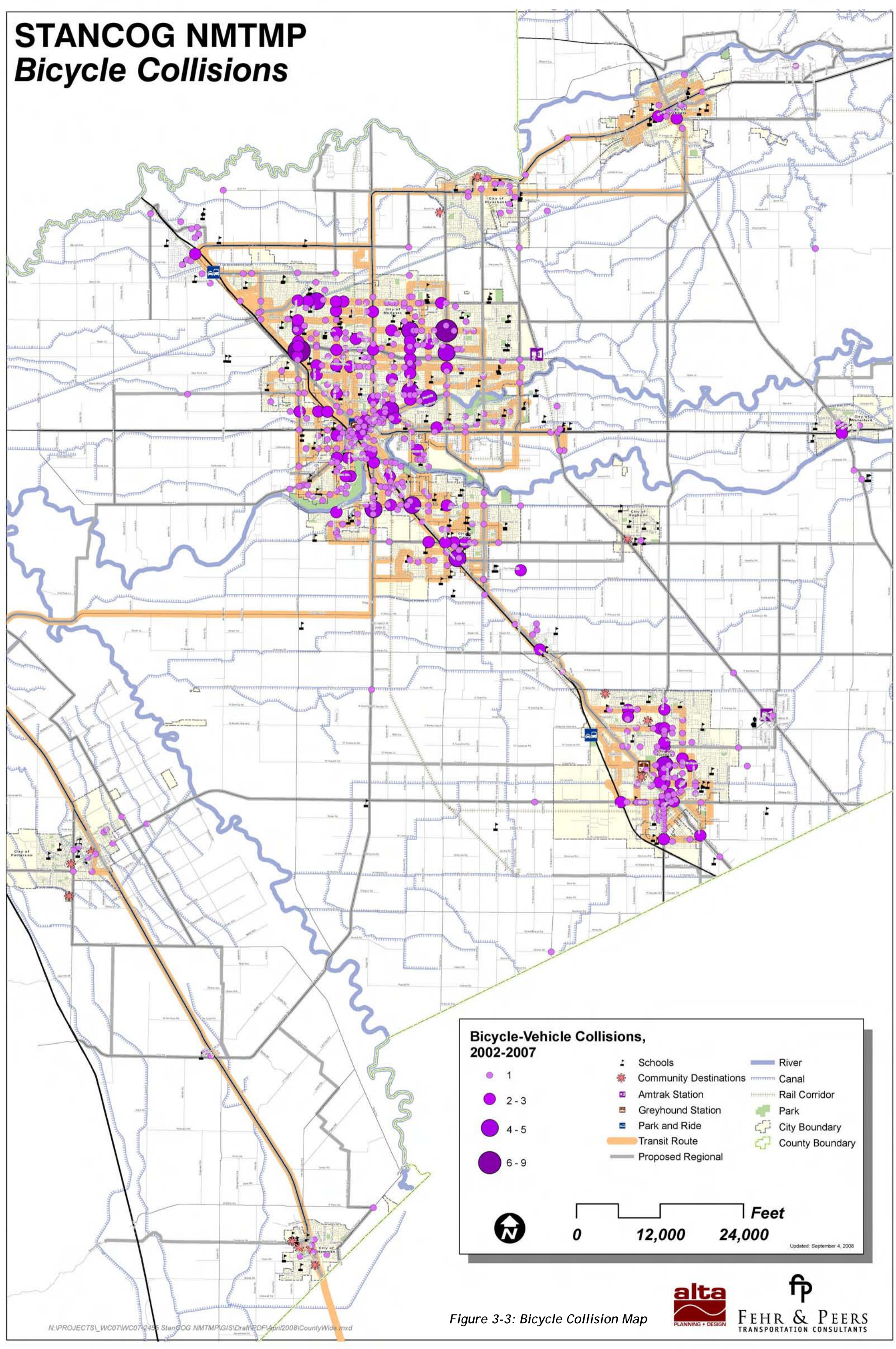

Figure 3-2: Pedestrian Collision Distribution

STANCOG NMTMP

Bicycle Collisions



Bicycle-Vehicle Collisions, 2002-2007

● 1	⚡ Schools	— River
● 2-3	⚡ Community Destinations	— Canal
● 4-5	⚡ Amtrak Station	— Rail Corridor
● 6-9	⚡ Greyhound Station	— Park
	⚡ Park and Ride	— City Boundary
	— Transit Route	— County Boundary
	— Proposed Regional	

Updated: September 4, 2008

Figure 3-3: Bicycle Collision Map

STANCOG NMTMP Pedestrian Collisions

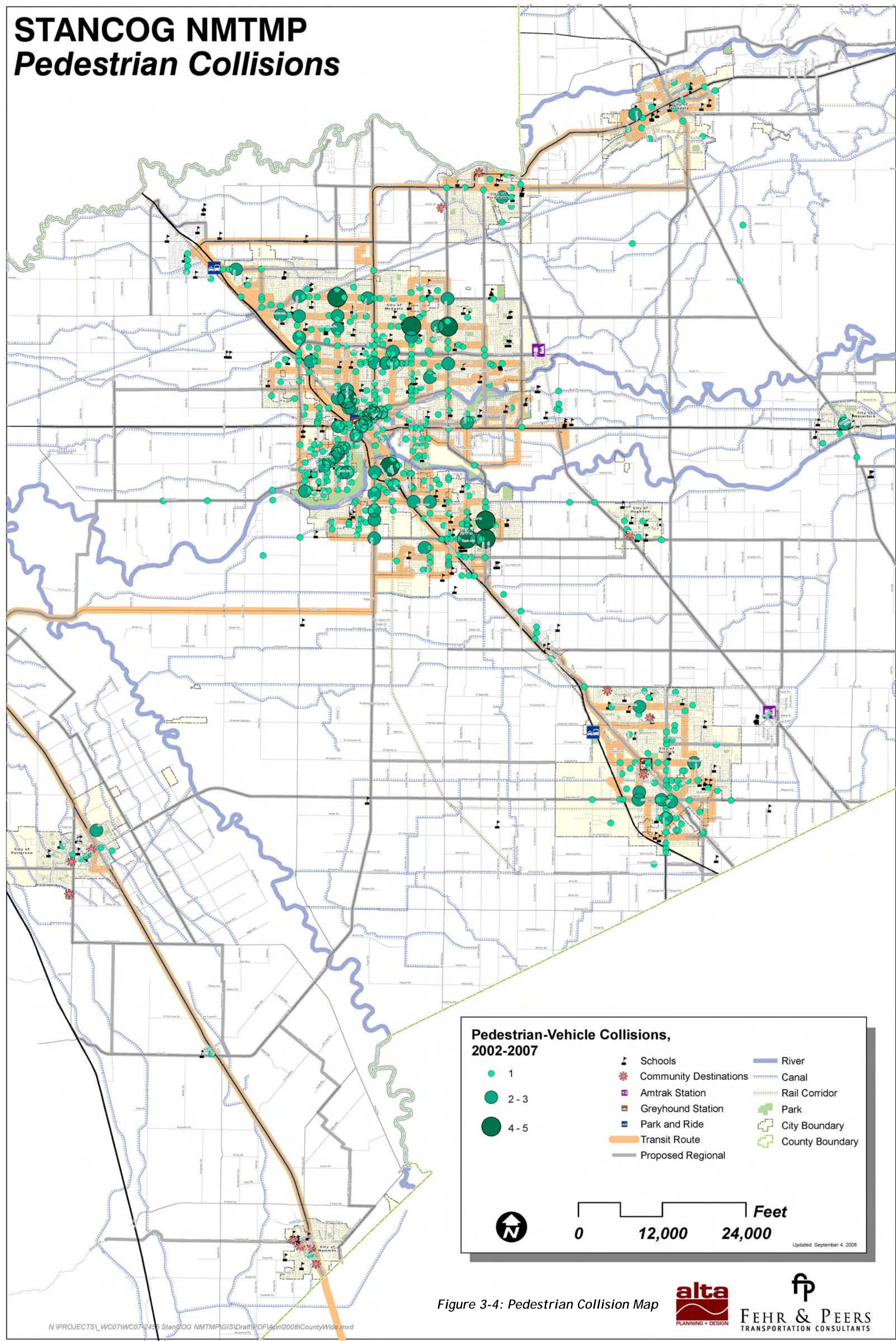

Pedestrian-Vehicle Collisions, 2002-2007

● 1	🏫 Schools	🌊 River
● 2-3	🌸 Community Destinations	🌊 Canal
● 4-5	🚉 Amtrak Station	🚂 Rail Corridor
	🚌 Greyhound Station	🌳 Park
	🚗 Park and Ride	🏙 City Boundary
	🛣 Transit Route	🌿 County Boundary
	🛣 Proposed Regional	

Updated: September 4, 2008

Figure 3-4: Pedestrian Collision Map

N:\PROJECTS\WC07\WC07-2455 Stancog NMTMP\GIS\Draft\PDF\April2008\CountyWide.mxd

3.7. Public Outreach

Representatives from the cities as well as members of the Modesto Bicycle Coalition served on the Bicycle and Pedestrian Advisory Committee (BPAC) for this plan. They identified the following needs and concerns which have been incorporated into the projects and programs in the following chapters.

- Need for a countywide bike route network with improved roadway shoulders.
- Long-term vision of a countywide network of Canal pathways connecting communities
- Pedestrian connections across obstacles such as highways and rivers
- Pedestrian improvements to access shopping and school areas
- Need for education and outreach such as “Share the Road”
- Need for a countywide bicycle and pedestrian coordinator to liaison between agencies and help secure funding

3.8. Future Usage and Benefits

A key goal of the Non-Motorized Transportation Master Plan is to maximize the number of local bicycle and pedestrian commuters in order to help reduce traffic congestion and air pollution. In order to set the framework for these benefits, national statistics and policies are used as a basis for determining the benefits to Stanislaus County. The latent need for bicycle and pedestrian facilities- versus actual bicyclists and pedestrians- is difficult to quantify; we must rely on evaluation of comparable communities to determine potential usage. Mode split refers to the choice of transportation people make whether for work or non-work trips. Currently, the average household in the U.S. generates about 10 vehicle trips per day. Work trips account for less than 30% of these trips on average. Using the available 2000 estimated population data, about 5,250 people Stanislaus County walk or bicycle for utilitarian reasons on an average day.

Alta has developed a state-of-the-art bicycle demand model that also estimates future usage and cost benefits. This is the first model of its type to be based on empirical data. As shown on the following tables, completion of the Countywide system will result in an estimated 5,369 daily bicyclists/pedestrian trips, saving over 6,727 vehicle miles daily. It is important to note that this is simply an order-of-magnitude estimate, based on available data.

Stanislaus County lies within the San Joaquin Valley Air Pollution Control District. According to the California Air Resources Board, as of July 2008, the air quality in the District did not meet the minimum State health-based standards for one-hour and eight-hour concentrations ground-level ozone, and the State standards for Particulate Matter (PM10) and Fine Particulate Matter (PM2.5).

According to the San Joaquin Valley Air Pollution Control District, motor vehicles are responsible for approximately 63% of the smog in the area. Fully implementing the Stanislaus bicycle network may help achieve reduces smog by providing residents improved options for getting to work, school, or shopping without relying on motor vehicles. Based on data from the 2000 Census and estimates of bicycle mode share for students, the current number of daily bicycle commuters (adjusted to include travel to work, to school and to transit trips) in Stanislaus County is estimated to be 4,488 riders, making 8,976 daily trips and saving an estimated 12,600 VMTs per weekday.

Table 3-4 quantifies the estimated reduction in VMTs in Stanislaus County following a modest increase in the adjusted bicycle mode share to 1.03%, and the estimated reduction from current levels in air pollutants based on the best available local and national data. It is conservatively estimated that the total number of work and school commuters could increase from the current estimate of 4,488 to 4,607. This would result in an estimated decrease of 87 kg/day of HC, 647 kg/day of CO, 43 kg/day of NOX 3,406,941 kg/day of CO2.

This improvement in air quality could be greater if improving conditions for bicyclists attracts bicyclists to the County whose trips originate outside of Stanislaus. As more attractive routes and gap closures are implemented, it will also encourage additional cycling.

Table 3-4: Future Bicycle Commute and Air Quality Projections

Current Commuting Statistics		Source
Stanislaus County Population	446,997	2000 US Census
Number of Commuters	170,169	2000 US Census (Employed persons minus those working at home)
Number of Bicycle-to-Work Commuters	1178	2000 US Census Journey to Work
Bicycle-to-Work Mode Share	0.69%	Mode share percentage of Bicycle to Work Commuters
School Children Grades K-8	54,382	2000 US Census, population ages 5-14
Estimated School Bicycle Commuters	2719	Lamorinda School Commute Study (Fehr & Peers Associates, 1995) and San Diego County School Commute Study (1990). (5%)
Number of College Students	10,270	2000 US Census
Estimated College Bicycle Commuters	514	National Bicycling & Walking Study, FHWA, Case Study No. 1, 1995. Review of bicycle commute share in seven university communities (5%)
Average Weekday Transit Ridership	11,057	Average of weekday system wide boardings.
Estimated Number of Daily Bike to Transit Users	77	GGT Existing Conditions System Levels Analysis Report 2005, Page 4-24
Estimated Total Number of Bicycle Commuters and Utilitarian Riders	4,488	Total of bike-to-work, transit, school, college and utilitarian bicycle commuters. Does not include recreation.
Estimated Adjusted Mode Share	1.0%	Estimated Bicycle Commuters divided by population
Estimated Current Bicycle Trips		
Total Daily Bicycle Trips	8,976	Total bicycle commuters x 2 (for round trips) plus total number of utilitarian bicycle trips
Reduced Vehicle Trips per Weekday	4,024	Assumes 73% of bicycle trips replace vehicle trips for adults/college students and 53% for school children
Reduced Vehicle Miles per Weekday	12,600	Assumes average one-way trip travel length of 4.6 miles for adults/college students and 0.5 mile for schoolchildren
Potential Future Bicycle Commuters		
Number of workers with commutes nine minutes or less	6,442	US Census 2000
Number of workers who already bicycle or walk to work	5,250	US Census 2000
Number of potential bicycle commuters	1,192	Calculated by subtracting number of workers who already bicycle or walk from the number of workers who have commutes 9 minutes or less
Future number of new bicycle commuters	119	Based on capture rate goal of 10% of potential bicycle riders
Total Future Daily Bicycle Commuters	4,607	Current daily bicycle commuters plus future bicycle commuters
Future Total Daily Bicycle Trips	9,214	Total bicycle commuters x 2 (for round trips)
Future Reduced Vehicle Trips per Weekday	6,727	Assumes 73% of bicycle trips replace vehicle trips
Future Reduced Vehicle Miles per Weekday	30,942	Assumes average one-way trip travel length of 4.6 miles for adults. Assumes 12 mph average bicycle speed; 23 minute average travel time. Travel time data from NHTS 2001 Trends, Table 26.
Future Reduced Vehicle Miles per Year	8,199,616	256 weekdays per year
Future Air Quality Benefits		
Reduced HC (kg/weekday)	87	(0.0028 kg/mile)
Reduced CO (kg/weekday)	647	(0.0209 kg/mile)
Reduced NOX (kg/weekday)	43	(0.00139 kg/mile)
Reduced CO2 (kg/weekday)	3,406,941	(.4155 kg/mile)
Reduced HC (metric tons/year)	22	1000 kg per metric ton; 256 weekdays/year
Reduced CO (metric tons/year)	166	1000 kg per metric ton; 256 weekdays/year
Reduced NOX (metric tons/year)	11	1000 kg per metric ton; 256 weekdays/year
Reduced CO2 (metric tons/year)	872,177	1000 kg per metric ton; 256 weekdays/year

Emissions rates from EPA report 420-F-00-013 "Emission Facts: Average Annual Emissions and Fuel Consumption for Passenger Cars and Light Trucks." 2000.

4. Recommended Bicycle Facilities

4.1. Introduction

The following describes the different types of bikeways and the phasing and prioritization for bikeway projects described later in this chapter. Bicycle improvements for unincorporated Stanislaus County and the cities of Ceres, Hughson, Newman, Oakdale, Patterson, Riverbank, Turlock, and Waterford.

Class I Pathways

Typically called a bike path, this facility provides for bicycle travel on a paved right of way completely separated from any street or highway. If a pathway is to be used primarily for recreation use and not with transportation funding, it may be constructed to reflect local conditions and needs.

Class I Bike Path

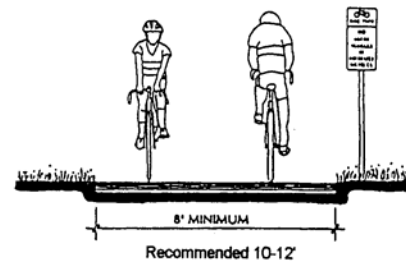
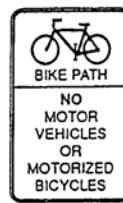

The locations for these pathway segments were determined using the previously-identified planning criteria, with the addition of the following factors:

- Need to make a connection through an area with limited or no on-street opportunity to install bikeways but opportunity to build a parallel pathway
- Opportunity to add a pathway along an existing public right-of-way such as a railroad or canal, particularly as an alternative to narrow, high-speed roadways
- High bicycle or school use, recreational activity or economic and/or housing development

It should be noted that of all the projects proposed in this plan, the pathways will require a higher level of environmental scrutiny compared to bicycle lanes and routes which typically have no environmental impact unless travel lanes are removed.

Class II Bicycle Lanes

Typically referred to as a bike lane, these facilities provide a striped and stenciled lane for one-way travel on a street or highway. Bicycle lanes are typically used in developed areas where traffic volumes require channelization of motorized and Non-Motorized users in order to achieve safe operations.

Many of the important roads for bicycling in Stanislaus County have insufficient width to accommodate Class II bike lanes. The majority of these are narrow rural roads or State Highways are striped at minimum lane widths with no paved shoulders and little room for continuous widening. In many cases this is due to topography, limited public right-of-way or existing drainage alongside the road. In addition, bicycle lanes have striping, stenciling and signing requirements that, when installed in

Class II Bike Lane

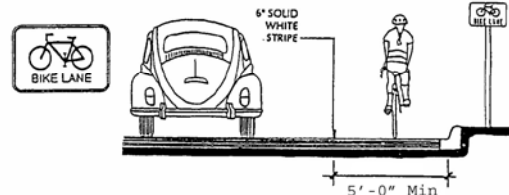

rural areas, may not be consistent with the local character of the roadway and surrounding environment. The Rural Roads Improvement Project described later in this chapter was created to address the unique challenges of these segments of Stanislaus County's bikeway system.

Class III Routes

A Class III Bikeway, also referred to as a bike route, provides for shared use with pedestrian or motor vehicle traffic and is typically identified only by signing. However, many rural bicycling roads in Stanislaus County are narrow and winding and some have high seasonal traffic volumes, shoulders of varying width, and some steep grades. As noted in the previous section about Class II Bicycle Lanes, application of

Class III Bike Route

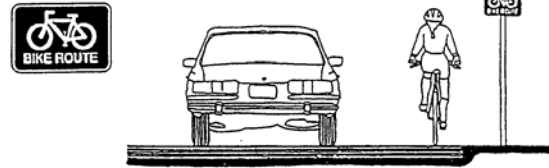

of Caltrans bikeway designs in these areas is difficult due to limited right of way and issues with difficulty of construction. As a long-term goal all Class III routes should provide a safe and consistent operating space for bicycles, with a goal of 4' of paved width outside the travel lane on either side of the roadway.

4.2. Developing the Bicycle Network

Creating a Network

A bikeway 'network' is a system of bicycle facilities that, for a variety of reasons including safety and convenience, provide a superior level of service for bicyclists. It is important to state that, by law, bicyclists are allowed on all streets and roads (except where specifically prohibited) regardless of whether these streets and roads are a part of the bikeway system. The bikeway network is a tool that allows the County to focus and prioritize implementation efforts where they will provide the greatest community benefit.

There is an established methodology for selecting a bikeway system for any community. As a Countywide Plan, one of the major goals of the Plan is to build on local bikeway networks already approved or proposed by communities. Thus, local plans provide the basis for some of the bikeway system. Another important criteria is input from the local bicycling community and local staff familiar with the best routes and existing constraints and opportunities. Input was received through a public survey, multiple meetings with the Steering Committee, from staff and via an extensive field survey and analysis process.

In addition, the consultant team considered some of the following criteria in selecting projects:

- Existing Bicycling Patterns based on reports from surveys and users
- Traffic volumes and travel speeds on streets
- Amount of side friction (driveways, side streets)
- Curb-to-curb width, available right of way and shoulder conditions
- Number of destinations served, including schools, parks and employment centers
- Topography and gradients
- Integration into the regional system
- Presence of reasonable alternatives for bicyclists
- Directness and connectivity to destinations
- Collision data and safety concerns

Countywide bicycle projects encompass physical or engineering improvements that will facilitate bicycle use throughout Stanislaus County. Recommended projects are signage improvements, bicycle support facilities including bicycle parking and changing facilities, improved transit connections, intersection improvements, and a proposed bicycle network that connects the county’s cities. This primary county bicycle network is described in this Chapter and followed by the unincorporated county and city recommendations.

4.3. Primary Countywide Bikeway Network

One of the key elements of a countywide bicycle plan is connecting communities through a network of direct and feasible proposed bikeway improvements. In Stanislaus County, there are a number of opportunities to make these connections. However any proposal must take into account the feasibility of constructing new bikeways over the sometimes long distances between cities.

The Primary Bikeway Network is a concept that includes the main corridors for connecting Stanislaus communities; most are in the unincorporated areas. This project proposes a phased approach in which existing roadway shoulders are targeted for spot improvements through a “Rural Roads Improvement Program” to create better bikeways in the short and mid-term. Many rural roads in Stanislaus County have high seasonal and truck traffic volumes, shoulders of varying width and high speeds. Application of Caltrans bikeway designs in these areas may be difficult due to the high cost of adding paved shoulders along the long distances connecting Stanislaus communities.

The Primary Bikeway Network also includes a long-term vision of a countywide pathway system (separate from roadways) to connect communities, utilizing a combination of canal and railroad existing public rights-of-way.

Table 4-1 and Figure 4-1 present the Primary Countywide Bikeway Network

Table 4-1: Primary Countywide Bikeway Network

Segment Number	From	To	Bikeway Class	Length (Miles)	Term
1	Patterson City Limits	Newman City Limits	Class I	10.33	Long-term
2A	Crows Landing Rd.	W Bradbury Rd.	Class I	4.75	Long-term
2A	W Bradbury Rd.	Crows Landing Rd.	Class I	0.74	Long-term
2A	Turlock City Limits	Crows Landing Rd.	Class I	5.05	Long-term
2B	SR 33	Prairie Flower Drain	Class II	5.37	Long-term
3	TID Lateral No 4	Moore Rd.	Class I	5.76	Long-term
4	Moore Rd.	Tully Rd.	Class I	3.80	Long-term
5	Ceres Main	Turlock City Limits	Class I	3.82	Long-term
6	S Santa Fe Ave.	Faith Home Rd.	Class I	1.99	Long-term
7	E Hatch Rd.	Yosemite Blv.	Class I	2.40	Long-term
8	Tuolumne River	S Santa Fe Ave.	Class I	2.95	Long-term
8	Geer Rd.	MID Main	Class I	3.33	Long-term
8	Tuolumne River	MID Lateral No 1	Class I	0.75	Long-term
9	Dry Creek	Albers Rd.	Class I	4.77	Long-term
9	Albers Rd.	Waterford City Limits	Class I	4.11	Long-term
10	Riverbank City Limits	Albers Rd.	Class I	8.12	Long-term
11	Riverbank City Limits	Oakdale City Limits	Class I	2.40	Long-term

Segment Number	From	To	Bikeway Class	Length (Miles)	Term
12	Claus Rd.	Oakdale City Limits	Class II	2.60	Near/Mid-term
13	Oakdale City Limits	Waterford City Limits	Class III	7.33	Near/Mid-term
14B	Turlock City Limits	S Santa Fe Ave.	Class II	2.66	Long-term
14A	Turlock City Limits	Oakdale City Limits	Class III	14.08	Near/Mid-term
15	Claus Rd.	N Eucalyptus Ave.	Class III	7.79	Near/Mid-term
16A	E Service Rd.	Crows Landing Rd.	Class II	0.51	Near/Mid-term
16A	E Whitmore Ave.	E Service Rd.	Class II	1.00	Near/Mid-term
16A	Ceres City Limits	E Grayson Rd.	Class II	0.49	Near/Mid-term
16A	SR 33	W Grayson Rd.	Class III	13.95	Near/Mid-term
17	San Joaquin River	Turlock City Limits	Class III	9.90	Near/Mid-term
17	Sycamore Ave.	San Joaquin River	Class III	2.01	Near/Mid-term
18	Modesto City Limits	Bridgewood Wy.	Class II	0.56	Near/Mid-term
18	Claribel Rd.	Modesto City Limits	Class II	0.75	Near/Mid-term
18	Crawford Rd.	Claribel Rd.	Class II	0.49	Near/Mid-term
Totals				134.56	

STANCOG NMTMP Primary Bikeway Network

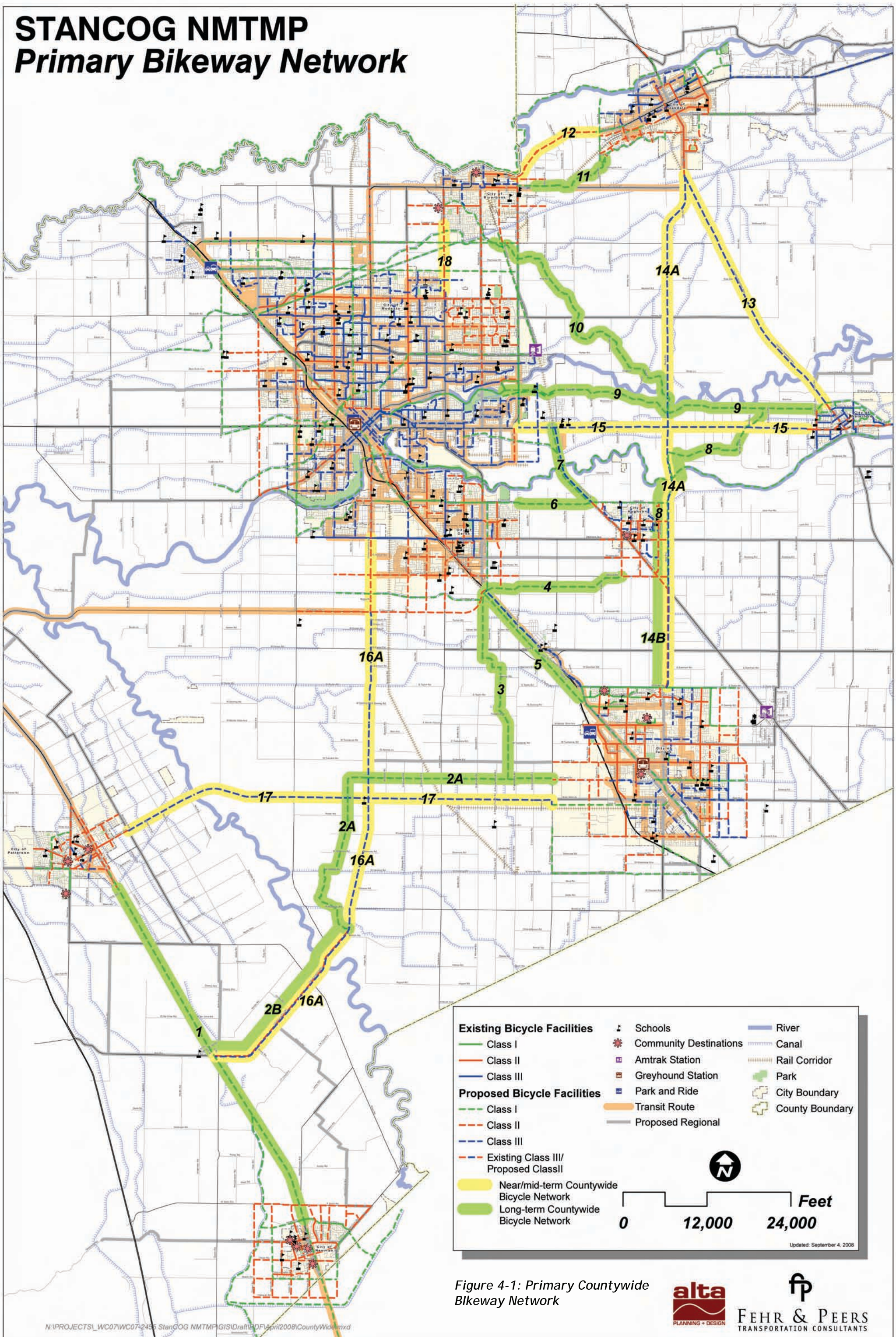

Figure 4-1: Primary Countywide Bikeway Network



4.4. Countywide Bicycle Facilities

Rural Roads Improvement Project

A variety of concerns have been expressed about the rural roads throughout the County, which are packaged into one effective countywide project here. These routes are the primary inter-community routes for cycling that, although they have limited opportunity for widening and additional paving, require some increased level of accommodation. The goal of the Rural Roads Improvement Project would be to identify and construct spot improvements along rural roads that typically are located outside of developed areas and have not (or limited) curbs, gutters, or sidewalks. This project would provide a mechanism to address specific concerns at locations along Stanislaus County's rural roads, which could be addressed through a combination of any of the following treatments:

- Bike Route wayfinding signs (minimum treatment)
- Advisory and warning signs, including, where appropriate, "Share the Road" signs
- Shoulder widening or new shoulders, especially on the uphill side of the road
- Travel lane re-striping where excess width is available
- New or improved turnouts and passing areas
- Enhanced roadway surface maintenance
- Speed limit reduction if supported by speed study.

All segments would be signed with Caltrans standard bicycle route signs. Wider shoulders would be prioritized according to a variety of factors with use and safety as key considerations. Locations such as blind corners or where sight distances are compromised would be priority locations for turnouts. Long segments of narrow roadway/narrow lanes and uphill segments would be prioritized for installation of periodic shoulder paving, widening, or passing areas. In addition, because these projects do not provide for consistent additional roadway width, Share the Road signs are recommended at key locations such as before a blind corner or location where sight is compromised.

Wayfinding and Share the Road Signage

Implementing a well-planned, attractive, and effective system of network signing greatly enhances bikeway facilities by promoting their presence to both existing and potential users. Currently Stanislaus County has only a few standard bike route signs. While some local street connections are identified within communities; very few continuous countywide routes between communities are identified.

Recommendation

Wayfinding signage can enhance a bikeway network by providing bicyclists directional assistance to facilities and significant local and regional destinations. It is recommended that Stanislaus County judiciously install a system of signs based on the completed bikeways network of Class I, II and III facilities to assist bicyclists in navigating around the County and reaching local destinations. The County should coordinate installation with other jurisdictions and agencies such as Caltrans to ensure complementary and effective signs. This signage program would work as a map on the street by identifying designated routes connecting to key destinations in Stanislaus.

All bikeway signage and striping on public roadways in Stanislaus County should conform to the signage identified in the current version of the California MUTCD. All signs should convey the "Four Ds": Direction, Destination, Distance and Distinction.



Sample Bike Route Signs

In addition, the County should integrate installation of Share the Road signs into the wayfinding system as needed on rural “Class III” roads. A Share the Road sign should be placed immediately adjacent to all “Welcome to Stanislaus County” signage on any bikeway to alert visitors that they should expect to see cyclists on the roadway. Other locations such as narrow and/or winding sections of road or corners with poor sightlines should also be prioritized for Share the Road sign placement.

The exact number, design and cost of signs to be installed would be determined during the design phase of this project.

Bikeway Support Facilities

Cyclists’ needs for bicycle parking range from simply a convenient piece of street furniture, to storage in a bicycle locker that affords weather, theft and vandalism protection, gear storage space, and 24-hour personal access. Most bicycles today cost 350 dollars to over 2,000 dollars and are one of the top stolen items in all communities, with components being stolen even when a bicycle is securely locked. Theft can be a serious deterrent to riding, especially for low-income riders or those with particularly expensive or rare bicycles. Where a cyclist’s needs falls on this spectrum is determined by several factors:

- **Type of trip being made:** whether or not the bicycle will be left unattended all day or for a few minutes.
- **Security of area:** determined by the cyclist’s perception
- **Value of the bicycle:** the more a cyclist has invested in a bicycle, the more concern she or he will show for theft protection or how prone a given area is to bicycle theft.

A final need for some potential commuting cyclists are shower, locker, and changing rooms at trip destinations. For those cyclists needing to dress more formally, travel longer distances, or cycle during wet or hot weather, the ability to shower and change clothing can be as critical as bicycle storage.

Types of Bicycle Parking

Bicycle parking facilities in California are classified as follows:

Class I parking is high security parking, usually with weather protection. This type of parking accommodates employees, residents, and commuters. Class I parking is considered long-term parking and is generally for those who expect to park more than two hours. Examples of Class I parking are storage lockers or restricted access covered areas that provide facilities for individually locked bicycles.

Bike lockers are covered storage units that typically accommodate one or two bicycles per locker, and provide additional security and protection from the elements. These are typically located at large employment center, colleges, and transit stations.

Bike corrals can be found at schools, stadiums, special events, and other locations, and typically involve a movable fencing system that can safely store numerous bicycles. Either locking the enclosure or locating it near other activities so that it can be supervised provides security.

Class II: Class II bicycle parking facilities are best used to accommodate visitors, customers, messengers and others expected to depart within two hours. Class II includes racks that provide two points of contact to allow both wheels and frame to be secured with a user-supplied lock. Bicycle racks provide support for the bicycle but do not have locking mechanisms. They are usually located at schools, commercial locations, and activity centers such as parks, libraries, retail locations, and civic centers.

Class III: Class III bicycle parking is the least secure. It provides only for securing one wheel and frame. This parking class can include street poles or wave bicycle racks.

Bicycle Parking Project

The goal of the bicycle parking project is to provide a cost-effective way to procure racks in bulk for distribution to the entire County and to provide bicycle rack specification and guidelines for installation that will ensure quality control for bicycle parking. Guidelines for location and placement of bicycle parking are provided in **Appendices A and C**. This project provides for improved bike parking based on destinations already identified in the plan and general recommendations for target levels of bike parking at transit stops, open space and around commercial and developed land uses.

In commercial areas, racks should be distributed according to adjacent land use in cooperation with local business owners, business managers and property owners, as appropriate. In general, racks should be distributed according to need and interest of adjacent businesses. For example, need for bicycle parking at parks or open space is determined by whether or not the park is primarily passive versus active i.e. do riders need to lock up their bicycles to engage in another activity such as hiking or are they riding there to simply enjoy open space, picnic, etc. with their bicycles nearby.

Appendix C provides sample language for a bicycle parking ordinance that could be adopted by Stanislaus County and the incorporated cities.

Multi-Modal Connections

Improving Non-Motorized access to transit is an important part of making walking and bicycling a part of daily life in Stanislaus County. Linking bicycles with public transit overcomes barriers such as trip distance, personal safety and security concerns, and riding at night, in poor weather, or up hills. This link also enables bicyclists to reach more distant areas for both recreation and transportation. Transit Routes can be seen on the proposed bikeway figures shown later in this chapter.

Bicycling to transit instead of driving benefits communities by reducing taxpayer costs, air pollution, demand for park-and-ride land, energy consumption and traffic congestion with relatively low cost investments.

There are four main components of bicycle-transit integration:

- allowing bicycles on transit;
- offering bicycle parking at transit locations;
- improving bikeways to transit within a three mile “catchment zone” radius
- encouraging usage of bicycle and transit programs.

About 1% of commuters use public transit in Stanislaus County. Stanislaus Regional Transit (StART) provides fixed route service to most County communities including Modesto, Ceres, Turlock, Patterson, Newman, Riverside, Oakdale, as well as shuttle service (providing curb-to-curb transportation between communities and cities) in Modesto, Riverbank, Oakdale, Ceres, and Turlock; “runabout” service (which combines designated fixed stops and a curb-to-curb service like a Dial-A-Ride) in Modesto, Waterford, and Hughson; and dial-a-ride service in Patterson, Newman, and Waterford.

Currently, the entire fleet of StART vehicles is equipped with bike racks, each carrying up to three bicycles at a time. Racks are usable at any time on a first-come, first-served basis except between dusk and dawn, because they impede bus headlight visibility. There is no additional fare for bicycles. Overflow bicycles are allowed inside StaRT vehicles in the wheelchair designated seat area of the bus. Reservations are needed for bikes on Dial-A-Ride shuttles.

In addition, Modesto Area Express (MAX) provides bike racks on all buses except for the BART Express route; Riverbank-Oakdale Transit Authority (ROTA) provides bike racks on all buses and trolleys; and Ceres Area Transit

Apply Pavement Stenciling Above All Bicycle Loop Detectors

Since most cyclists, as well as motorists, do not know how loop detectors work, all detector loops expected to be used by cyclists should be marked by a pavement stencil that shows cyclists where to stop to activate the loop. Educational materials distributed by the County should describe how to activate bicycle loop detectors. Stencils should be repainted when needed.

4.5. Unincorporated County Bicycle Facilities

Planning and Policy Context

The following summarizes past planning efforts and establishes a policy framework to guide future transportation decisions and capital improvement programming. This undertaking is intended to promote regional planning, offer opportunities to coordinate infrastructure improvements, and to incorporate past planning efforts into the Current Plan.

Stanislaus County General Plan (2007)

The purpose of this plan is to meet state planning requirements and to assist decision makers in coordinating land use and infrastructure decisions. Both the Circulation and Open Space elements contain policies relevant to the Non-Motorized Transportation Plan goals. The General Plan contains maps showing land use designations in the County. **Figure 4-2** shows the Stanislaus General Plan Map.

Regional Bicycle Action Plan (2001)

The Regional Bicycle Action Plan provides a county-wide overview of existing bicycle facilities, proposed facilities (separated into low-, intermediate-, and high-cost), design guidelines, and transportation and land use planning guidelines to support bicycle transportation.

The Plan's overall goal is "To increase the use of bicycles for trips to work, school, shopping, entertainment, and other purposes and promote the use of the bicycle for transportation through a comprehensive regional bicycle facility network and public education program." It includes policies encouraging the construct a bicycle network, bicycle safety, bicycle friendly infrastructure, bicycle friendly development and education programs. The plan also lists funding priority and priority bikeways recommended for implementation.

Transportation Improvement Plan (2007)

The Federal Transportation Improvement Plan (TIP) describes funding sources for Non-Motorized projects, and lists funded projects. Pedestrian and bicycle projects funded under the 2007 TIP include:

- Ceres, Hatch Road Pedestrian/Bicycle Path
- Hughson, Locust Street Sidewalks
- Hughson, Pine Street Sidewalks
- Modesto, South Scenic Drive Bicycle Trailhead
- Modesto, Tuolumne River Regional Park River Walk
- Modesto, VA Corridor-Briggsmore Bicycle- Pedestrian Overpass
- Modesto, California Avenue/Mark Twain Jr. High School Safe Routes to School Improvements
- Modesto Curb Ramps
- Oakdale, Valley View Drive to Kerr Park Multi-use trail
- Oakdale, extension of Pedestrian/Bicycle Trail
- Oakdale, J Street and Oak Valley Park Bicycle Lanes
- Patterson, M Street and Highway 33, bicycle-pedestrian crossing
- Riverbank, First Street Sidewalks

- Riverbank, Terminal and Patterson Roads Sidewalks
- Riverbank, California Street and Riverbank High School Sidewalk and Ramps
- Riverbank, Jacob Meyers Park Trails
- Stanislaus County, Non-Motorized Transportation Plan
- Turlock, Class I Bicycle Path
- Turlock, Elementary School Crosswalks
- Waterford, Welch Street (Amy to Bentley) Bicycle Path
- Waterford, Western Avenue (SR 132 to Kadota) Bicycle/Pedestrian Facility
- Waterford, Moon, Waterford Middle School and High School Sidewalks and Bicycle Lanes
- The 2007 TIP also includes the following amendments to the 2004 TIP:
- City of Patterson, Program Class I&II Bike Lanes and Pedestrian Facilities
- StanCOG, Programs CON for (CMAQ eligible elements) Sidewalks, curb, gutter, and bike facilities of the larger STIP Project
- Recreational Trails Funds City of Riverbank, Programs Trails project in Jacob Meyers Park
- RSTP StanCOG, Programs the 2006 Non-Motorized Plan for the Stanislaus Region

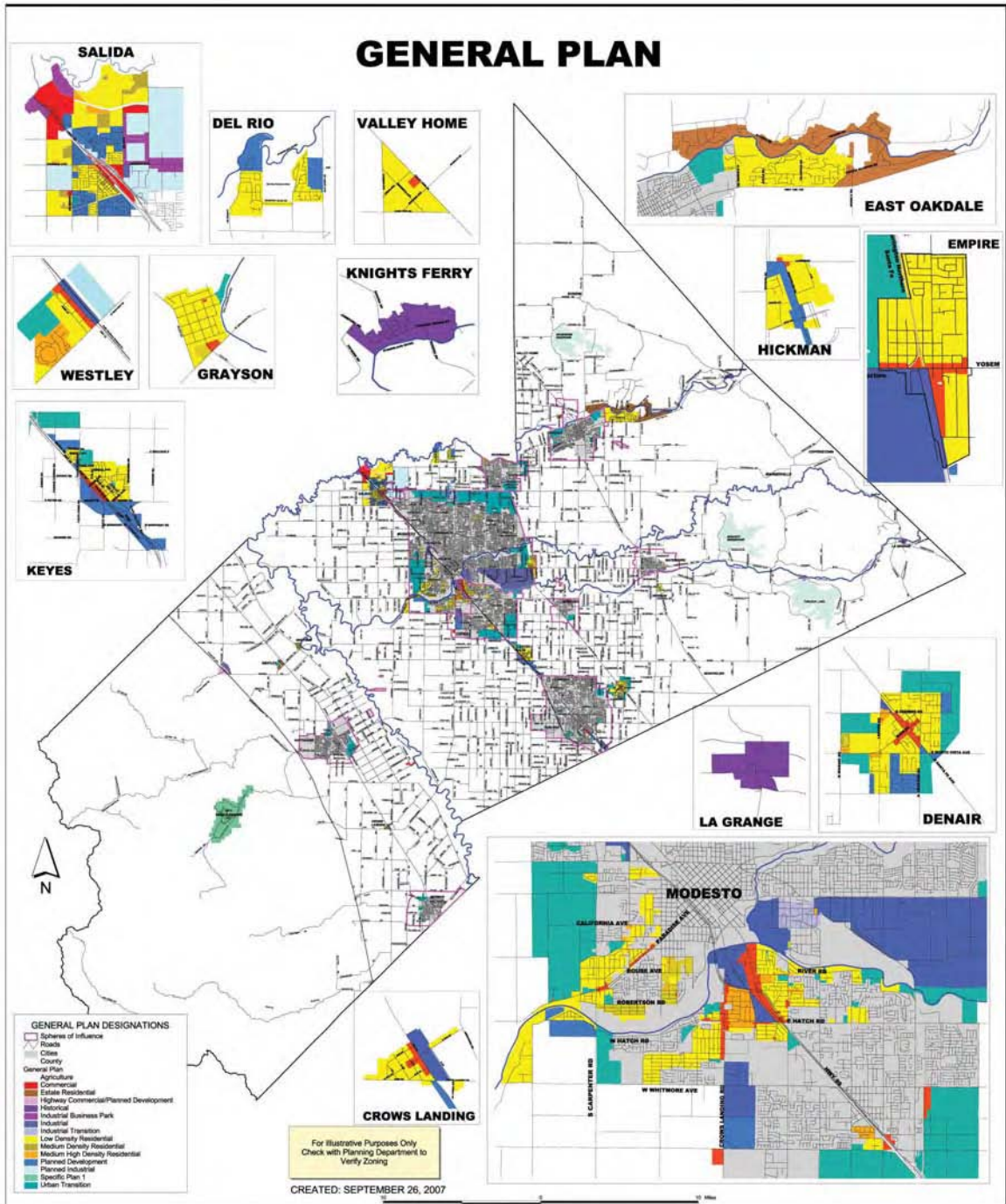

Figure 4-2: Stanislaus County General Plan Map

Stanislaus County Network Vision and Strategy

Stanislaus County has a growing reputation as a desirable, livable community. One of the aspects that makes a community livable are places where people feel comfortable bicycling, whether they be school children or senior citizens. The purpose of this plan is to identify how bicycle improvements may be incorporated in local communities based on local plans.

The Unincorporated Stanislaus County bikeway system was developed focusing on connecting communities and destinations within communities, addressing routes used by bicyclists, and focusing on specific opportunities and constraints. The bikeway system and the top projects serve as guidelines to those responsible for implementation. The system and segments themselves may change over time as a result of changing bicycling patterns and implementation constraints and opportunities. **Table 4-2** and **Figure 4-3** include the details for the Countywide Bikeway Network. Additionally, the subsequent sections include recommended facilities in the county's cities.

Table 4-2: Recommended Countywide Bikeway Network

Segment Name	From	To	Bikeway Class	Length (Miles)	Status	Primary Segment	Cost
N Johnson Rd.	E Hawkeye Ave.	East Ave.	II	1.00	Existing		Existing
		Total Existing		1.00			
7th St.	E Hatch Rd.	E Service Rd.	II	2.00	Proposed		\$56,500
Balsam Dr. Extension	W Stuhr Rd.	Sherman Pkwy.	II	0.47	Proposed		\$13,200
Barrington Ave. Extension	E Stuhr Rd.	Sherman Pkwy.	II	0.48	Proposed		\$13,700
Beard Ave.	Yosemite Blv.	Nathan Ave.	III	0.49	Proposed		\$6,200
Blaker Rd.	Ceres City Limits	E Grayson Rd.	II	0.40	Proposed		\$11,400
Blue Gum Ave.	East of Dakota Ave.	Modesto City Limits	II	1.40	Proposed		\$39,400
Boothe Rd.	Whitmore Ave.	Canal	II	1.33	Proposed		\$37,400
Brier Rd.	S Berkeley Ave.	S Daubenberger Rd.	II	0.76	Proposed		\$21,500
Canal School Rd. Extension	E Inyo Ave.	South City Limits	I	0.49	Proposed		\$407,100
Canal School Rd. Extension	South of City Limits	Class II Connection	II	0.51	Proposed		\$14,300
Central Ave.	E Service Rd.	E Grayson Rd.	II	1.01	Proposed		\$28,300
Ceres Main	TID Lateral No 4	Moore Rd.	I	5.76	Proposed	3	\$4,801,600
Cinnamon Teal Wy. Extension	E Stuhr Rd.	Sherman Pkwy.	II	0.59	Proposed		\$16,700
Claribel Rd.	Sisk Rd.	Oakdale Rd.	I	6.53	Proposed		\$5,442,000
Class I Along Canal	N Daubenberger Rd.	N Verduga Rd.	I	0.50	Proposed		\$414,400
Class I Along Canal	North of W Stuhr Rd.	South of Shiells Rd.	I	6.91	Proposed		\$5,760,700
Class I Along Canal	Semallon Dr.	Claribel Rd.	I	3.00	Proposed		\$2,500,000
Class I Connection	Southern Border of Newman	Eastern Border of Newman	I	6.22	Proposed		\$5,185,500
Class I Connector	Canal	SR 99	I	1.20	Proposed		\$999,500
Class I Connector	Ceres Main	Turlock City Limits	I	3.82	Proposed	5	\$3,185,000
Class I Connector	Hills Ferry Rd.	Class I Connector	I	0.94	Proposed		\$786,100
Class I Connector	Riverbank City Limits	Oakdale City Limits	I	2.40	Proposed	11	\$1,996,900
Class II Connector	Class II Connector	Hills Ferry Rd.	II	0.44	Proposed		\$12,300
Class II Connector	Draper Rd.	Canal School Rd. Extension	II	2.25	Proposed		\$63,400
Class II Connector	Orestimba Rd.	Canyon Creek Dr.	II	0.88	Proposed		\$24,800
Class III Connector	Walnut St.	West Of City Boundary	III	0.14	Proposed		\$1,800

Segment Name	From	To	Bikeway Class	Length (Miles)	Status	Primary Segment	Cost
Claus Rd.	Claribel Rd.	Sylvan Ave.	I	1.50	Proposed		\$1,251,100
Coffee Rd.	Claribel Rd.	Modesto City Limits	II	0.76	Proposed		\$21,400
Covert Rd.	Finney Rd.	Toomes Rd.	III	0.50	Proposed		\$6,300
Crawford Rd.	Coffee Rd.	Oakdale Rd.	II	1.00	Proposed		\$28,200
Crows Landing Rd.	Ceres City Limits	E Grayson Rd.	II	0.49	Proposed	16A	\$13,900
Crows Landing Rd.	E Whitmore Ave.	E Service Rd.	II	1.00	Proposed	16A	\$28,200
Crows Landing Rd.	SR 33	Prairie Flower Drain	II	5.37	Proposed	2B	\$151,500
Crows Landing Rd.	SR 33	W Grayson Rd.	III	13.95	Proposed	16A	\$175,800
Dakota Ave.	SR 99	Canal	I	4.09	Proposed		\$3,406,000
Doherty Ave.	Lapham Dr.	Canal	III	0.48	Proposed		\$6,100
Draper Rd.	Draper Rd.	Hallowell Rd.	II	2.51	Proposed		\$70,700
E Hatch Rd.	S Santa Fe Ave.	Faith Home Rd.	I	1.99	Proposed	6	\$1,662,000
E Hatch Rd.	S Santa Fe Ave.	Geer Rd.	I	2.05	Proposed		\$1,709,000
E Las Palmas Ave.	S Hartley St.	Sycamore Ave.	II	0.57	Proposed		\$16,100
E Las Palmas Ave.	Sycamore Ave.	San Joaquin River	III	2.01	Proposed	17	\$25,300
E Linwood Ave.	Paulson Rd.	S Johnson Rd.	II	0.11	Proposed		\$3,000
E Linwood Ave.	S Johnson Rd.	S Verduga Rd.	III	1.01	Proposed		\$12,700
E Service Rd.	Moore Rd.	Faith Home Rd.	II	0.86	Proposed		\$24,200
E Service Rd.	Tully Rd.	Geer Rd.	II	1.25	Proposed		\$35,300
E Service Rd.	Ustick Rd.	Crows Landing Rd.	II	1.00	Proposed		\$28,200
E Taylor Rd.	Turlock City Limits	N Waring Rd.	I	0.75	Proposed		\$626,000
E Whitmore Ave.	West of Mountain View Rd.	Geer Rd.	II	1.84	Proposed		\$51,900
Eucalyptus Ave. Extension	E Stuhr Rd.	Sherman Pkwy.	II	0.49	Proposed		\$13,700
Euclid Ave.	E Hatch Rd.	S Santa Fe Ave.	II	1.95	Proposed		\$54,900
Fig Ln. Extension	W Stuhr Rd.	Newman City Limits	II	0.58	Proposed		\$16,400
Finch Rd.	Mitchell Rd.	Codoni Ave.	III	1.84	Proposed		\$23,200
Finney Rd	Murphy Rd.	Driftwood Dr.	III	0.83	Proposed		\$10,400
Fox Rd.	Tully Rd.	Greer Rd.	II	1.25	Proposed		\$35,300
Frazine Rd.	North of La Coste Ln.	Finch Rd.	III	2.15	Proposed		\$27,100
Fulkerth Rd.	N Washington Rd.	N Tegner Rd.	II	1.00	Proposed		\$28,100
Garner Rd.	Yosemite Blv.	Finch Rd.	II	0.91	Proposed		\$25,600
Geer Rd.	Tuolumne River	MID Lateral No 1	I	0.75	Proposed	8	\$627,400
Geer Rd.	Tuolumne River	S Santa Fe Ave.	I	2.95	Proposed	8	\$2,457,400
Geer Rd.	Turlock City Limits	S Santa Fe Ave.	II	2.66	Proposed	14B	\$75,100
Geer Rd.	Turlock City Limits	Oakdale City Limits	III	14.08	Proposed	14A	\$177,400
Harvey Rd.	Class I	Shiells Rd.	I	1.38	Proposed		\$1,149,400
Harvey Rd.	Shiells Rd.	Hallowell Rd.	II	0.50	Proposed		\$14,200
Harvey Rd.	W Stuhr Rd.	Class I	II	0.63	Proposed		\$17,700
Hills Ferry Rd.	E Stuhr Rd.	Sherman Pkwy.	II	0.85	Proposed		\$24,100
Hills Ferry Rd.	Sherman Pkwy.	Driskell Ave.	I	0.52	Proposed		\$437,400
Hoyer Rd.	Draper Rd.	Ceres City Limits	II	0.76	Proposed		\$21,400
HWY 108	Claus Rd.	Oakdale City Limits	II	2.60	Proposed	12	\$73,300
HWY 108	Riverbank City Limits	Claus Rd.	II	0.27	Proposed		\$7,500
HWY 99	County Limits	Kiernan Ct.	I	0.51	Proposed		\$424,600
HWY 99	HWY 99 Path	Kiernan Ct	III	1.47	Proposed		\$18,500
Inyo Ave. Extension	Canal School Rd.	Class I Connector	II	0.71	Proposed		\$20,100

Segment Name	From	To	Bikeway Class	Length (Miles)	Status	Primary Segment	Cost
Kiernan Ave.	Salida Blvd.	Toomes Rd.	III	0.53	Proposed		\$6,600
Mariposa Rd.	Yosemite Blv.	Finch Rd.	III	1.00	Proposed		\$12,600
Maze Blv.	Dakota Ave.	S Carpenter Rd.	I	2.03	Proposed		\$1,688,400
McHenry Avenue	Pelandale Ave	County Line	II	4.41	Proposed		\$116,700
MID Lateral No 1	Geer Rd.	MID Main	I	3.33	Proposed	8	\$2,774,800
MID Lateral No 2	Dry Creek	Albers Rd.	I	4.77	Proposed	9	\$3,972,700
Mid Lateral No. 1	N Riverside Dr.	S Santa Fe Ave.	I	2.70	Proposed		\$2,247,100
Mid Lateral No. 7	Standiford Ave	W of Finney Rd.	I	3.72	Proposed		\$3,101,500
MID Main	Albers Rd.	Waterford City Limits	I	4.11	Proposed	9	\$3,426,400
MID Main	Riverbank City Limits	Albers Rd.	I	8.12	Proposed	10	\$6,764,600
Moore Rd.	Service Rd.	Canal	I	0.33	Proposed		\$276,100
Morgan Rd.	Ceres City Limits	E Grayson Rd.	II	0.40	Proposed		\$11,300
Morrill Rd.	Coffee Rd.	Oakdale Rd.	II	1.00	Proposed		\$28,200
Morse Rd. Extension	SR 99	Blue Gum Ave.	II	1.29	Proposed		\$36,300
N Golden State Blv.	Turlock City Limits	Moore Rd.	III	3.74	Proposed		\$47,200
N Quincy Rd.	E Taylor Rd.	Turlock City Limits	II	1.28	Proposed		\$36,100
N Santa Fe Ave.	Canal	Claus Rd.	I	1.76	Proposed		\$1,469,700
N Verduga Rd.	N Waring Rd.	E Linwood Ave.	II	2.36	Proposed		\$66,400
N Waring Rd.	E Taylor Rd.	Turlock City Limits	II	1.28	Proposed		\$36,100
Nathan Ave.	Doherty Ave.	Beard Ave.	III	0.42	Proposed		\$5,300
Nebraska Ave.	Kansas Ave.	Paradise Rd.	II	2.39	Proposed		\$67,500
North Side of Stanislaus River	Valley Home Rd.	HWY 99	I	24.29	Proposed		\$20,240,300
Oakdale Rd.	Modesto City Limits	Claribel Rd.	II	0.75	Proposed	18	\$21,200
Oakdale Waterford Hwy	Oakdale City Limits	Waterford City Limits	III	7.33	Proposed	13	\$92,300
Ohio Ave.	California Ave.	Robertson Rd.	III	1.18	Proposed		\$14,900
Orestimba Rd.	Draper Rd.	Newman City Limits	II	0.79	Proposed		\$22,300
Paradise Rd.	Morse Rd. Extension	S Carpenter Rd.	II	1.09	Proposed		\$30,800
Prairie Flower Drain	W Bradbury Rd.	Crows Landing Rd.	I	0.74	Proposed	2A	\$617,900
Prince Rd.	Newman City Limits	Class II Connector	II	0.49	Proposed		\$13,800
Proposed Class III	7th St.	Proposed Class III	III	0.20	Proposed		\$2,500
Proposed Class III	E Whitmore Ave.	Euclid Ave.	III	0.72	Proposed		\$9,000
Roeding Rd.	Mountain View Rd.	7th St.	II	1.00	Proposed		\$28,300
Roselle Ave.	Claribel Rd.	Modesto City Limits	II	1.14	Proposed		\$32,100
S Carpenter Rd.	Modesto City Limits	W Whitmore Ave.	I	0.93	Proposed		\$777,600
S Carpenter Rd.	W Whitmore Ave.	South of W Whitmore Ave.	II	0.18	Proposed		\$4,900
S Daubenberger Rd.	Brier Rd.	E Linwood Ave.	III	0.50	Proposed		\$6,300
S Daubenberger Rd.	East Ave.	Brier Rd.	II	0.51	Proposed		\$14,400
S Golden State Blv.	Turlock City Limits	County Boundary	I	1.86	Proposed		\$1,549,100
S Quincy Rd.	East Ave.	E Linwood Ave.	III	1.01	Proposed		\$12,700
S Riverside Dr.	Yosemite Blv.	Mitchell Rd.	III	0.84	Proposed		\$10,600
S Santa Fe Ave.	E Hatch Rd.	Yosemite Blv.	I	2.40	Proposed	7	\$2,001,100
S Santa Fe Ave.	E Hatch Rd.	Yosemite Blv.	III	2.35	Proposed		\$29,600
S Santa Fe Ave.	E Hatch Rd.	Geer Rd.	II	3.13	Proposed		\$88,300
S Walnut Rd.	Simmons Rd.	W Harding Rd.	II	0.49	Proposed		\$13,800
S Washington Rd.	Clayton Rd.	W Harding Rd.	I	1.25	Proposed		\$1,044,900

Segment Name	From	To	Bikeway Class	Length (Miles)	Status	Primary Segment	Cost
Shiells Rd. Extension	Draper Rd.	Harvey Rd.	II	0.50	Proposed		\$14,200
Shoemake Ave.	Dakota Ave.	Modesto City Limits	II	1.25	Proposed		\$35,200
Simmons Rd.	S Walnut Rd.	Lander Ave.	II	1.00	Proposed		\$28,200
SR 33	Newman City Limits	County Boundary	I	3.64	Proposed		\$3,037,800
SR 33	Patterson City Limits	Newman City Limits	I	10.33	Proposed	1	\$8,605,300
SR 33	Patterson City Limits	Sperry Ave.	I	0.58	Proposed		\$480,300
TID Lateral No 2	Moore Rd.	Tully Rd.	I	3.80	Proposed	4	\$3,164,200
TID Lateral No 4	Crows Landing Rd.	W Bradbury Rd.	I	4.75	Proposed	2A	\$3,960,800
TID Lateral No 4	Turlock City Limits	Crows Landing Rd.	I	5.05	Proposed	2A	\$4,210,500
Tully Rd.	Fox Rd.	E Service Rd.	II	1.50	Proposed		\$42,400
Tully Rd.	Kiernan Ave.	Pelandale Ave.	II	0.73	Proposed		\$20,400
Tuolomne River	Mitchell Rd	S Reainway Ave.	I	12.37	Proposed		\$10,309,600
Turlock City Limits	East Ave.	E Linwood Ave.	II	1.01	Proposed		\$28,400
Upper Rd.	Newman City Limits	Hallowell Rd.	II	0.49	Proposed		\$13,900
W Grayson Rd.	S Carpenter Rd.	Moore Rd.	II	5.54	Proposed		\$156,200
W Harding Rd.	S Washington Rd.	SR 99	I	4.46	Proposed		\$3,719,900
W Redwood Rd.	Ustick Rd.	Crows Landing Rd.	I	1.01	Proposed		\$837,700
W Stuhr Rd.	Draper Rd.	Hills Ferry Rd.	II	3.17	Proposed		\$89,400
West Main St.	San Joaquin River	Turlock City Limits	III	9.90	Proposed	17	\$124,700
Yosemite Blv.	Claus Rd.	N Eucalyptus Ave.	III	7.79	Proposed	15	\$98,200
		Total Proposed		322.39			\$138,820,400

STANCOG NMTMP

Countywide Bicycle Network

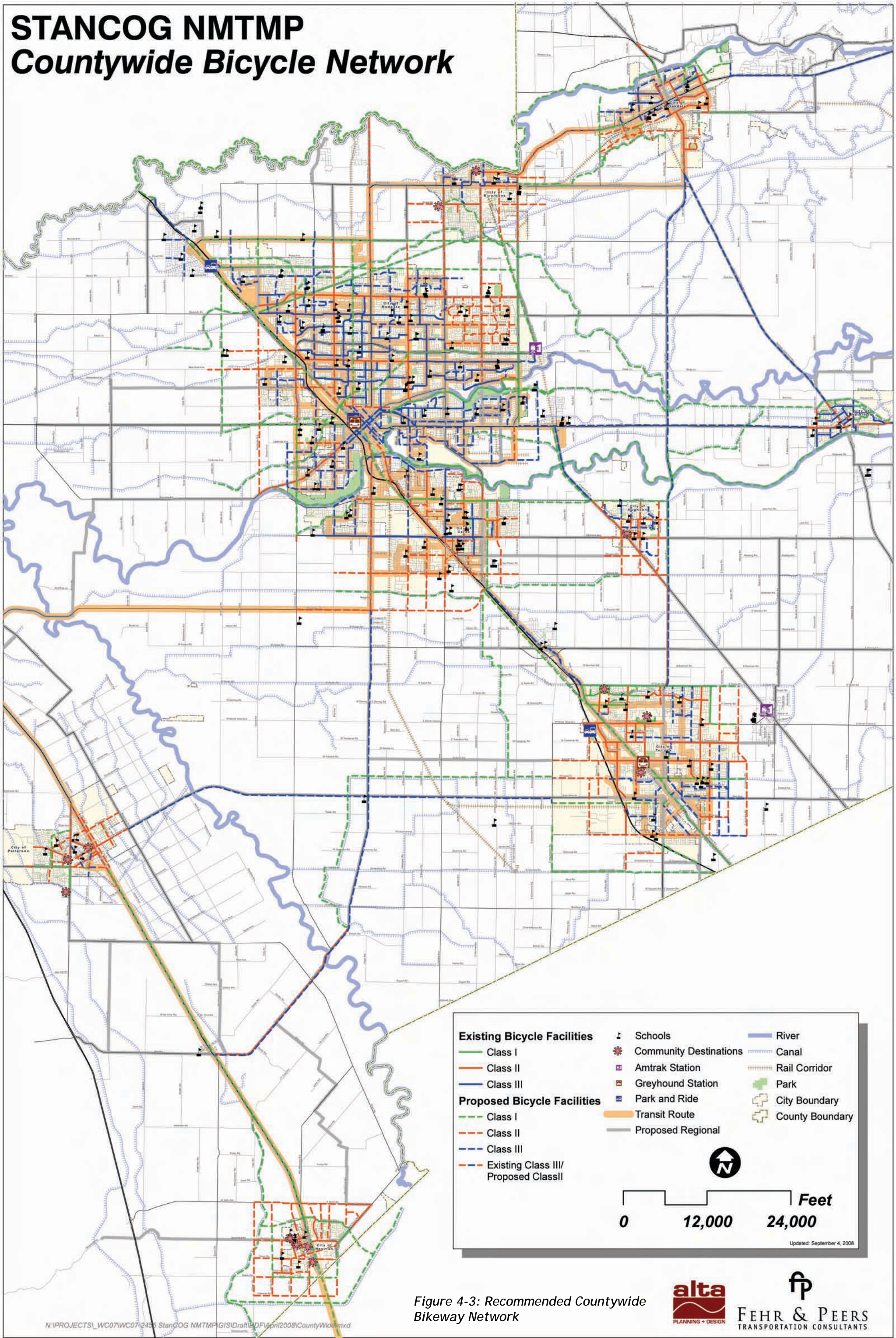

Existing Bicycle Facilities	<ul style="list-style-type: none"> Schools Community Destinations Amtrak Station Greyhound Station Park and Ride Transit Route Proposed Regional 	<ul style="list-style-type: none"> River Canal Rail Corridor Park City Boundary County Boundary
Proposed Bicycle Facilities	<ul style="list-style-type: none"> Class I Class II Class III Existing Class III/ Proposed Class II 	

0 12,000 24,000 Feet
 Updated: September 4, 2008

Figure 4-3: Recommended Countywide Bikeway Network



4.6. City of Ceres

Planning and Policy Context

The following summarizes past planning efforts and establishes a policy framework to guide future transportation decisions and capital improvement programming. This undertaking is intended to promote regional planning, offer opportunities to coordinate infrastructure improvements, and to incorporate past planning efforts into the Current Plan.

Ceres General Plan (1997)

The General Plan devotes significant attention to Non-Motorized transportation in the Land Use and Community Design and Transportation and Circulation elements. A bicycle circulation map is included as Figure 2-2 in the Plan. The Plan states that “Improving the ability for Ceres residents and workers to walk or bike not only reduces automobile trips, with benefits for air quality, but it also promotes greater community interaction. This is one of the small-town qualities that the General Plan seeks to preserve and enhance.”

Several Land Use and Community Design policies apply to designing new residential and commercial development to promote bicycling and walking. Transportation and Circulation policies promote connectivity and walking and bicycling on residential streets, bicycle parking, and development of a comprehensive bicycle network. Additionally, the Public Facilities and Services element includes a policy to encourage siting schools in areas with safe and convenient pedestrian and bicycle access. Similarly, the Recreational and Cultural Resources element includes a policy to provide access to neighborhood parks via trails, bikeways, and sidewalks. The Recreational and Cultural Resources element encourages the use of alternative modes by requiring new development to provide adequate pedestrian and bicycle facilities.

Proposed implementation programs include development of residential design guidelines to promote pedestrian and bicycle-friendly development; review of local street width requirements to identify opportunities for narrower, more pedestrian-friendly streets; revision of the Zoning Ordinance and development standards to incorporate bicycle parking standards; negotiating with the Turlock Irrigation District to use canal rights-of-way for pedestrian pathways and Class I bikeways; and including provisions for funding non-automotive transportation in capital improvement planning.

Mitchell Road Specific Plan (1995)

The Mitchell Road Specific Plan includes limited provisions for Non-Motorized transportation. As stated in the Appendix, "Specific Plan Design Guidelines provide for pedestrian walkways along major streets and connector streets, which connect developments through natural open space areas," and "The Design Guidelines encourage bicycle lanes along secondary roadways and canals, in addition to the development of courtyards, atriums, and other outdoor gathering and eating areas."

Existing Conditions

Located along Highway 99, Ceres is home to over 34,000. The City's is nearly 7 square miles of flat terrain. Existing bicycle facilities include over 13 miles of bikeways. The majority of Ceres' bikeways, over nine miles, are Class III facilities. The remaining bikeways are both Class I and Class II facilities.

Proposed Improvements

Proposed Class I facilities in Ceres include an east-west path along the canal south of Gondring Road, a north-south path along Moore Road, connecting to an extension of the Hatch Road path to the east. A proposed Class I path along the railroad corridor adjacent to South 7th Street would connect into downtown Modesto.

Class II bike lanes are proposed on many of Ceres' major cross-town roads, including Whitmore Avenue, Service Road, Crows Landing Road, Blaker Road/Richland Avenue, Central Avenue, and Esmar Road/Boothe Road, as well as El Camino Avenue and Herndon Road (parallel to State Route 99).

No Class III bicycle routes are proposed in Ceres.

Table 4-3 and **Figure 4-4** include details for the Ceres bikeway network.

Table 4-3: Ceres Existing and Proposed Bikeway Network

Segment Name	From	To	Bikeway Class	Length (Miles)	Status	Primary Segment	Cost
Boothe Rd.	E Hatch Rd.	Rhone Dr.	II	0.25	Existing		Existing
Boothe Rd.	Just North of Whitehaven Ave.	Whitmore Ave.	II	0.33	Existing		Existing
Calcagno St.	Central Ave.	Lynley Dr.	III	0.34	Existing		Existing
Calcagno St.	Lynley Dr.	Running Ln.	III	0.11	Existing		Existing
Central Ave.	E Whitmore Ave.	River Rd.	III	1.83	Existing		Existing
Charlottesville Ln.	Central Ave.	Mitchell Rd.	I	1.01	Existing		Existing
E Hatch Rd.	Charlottesville Ln.	Eastgate Blv.	I	0.52	Existing		Existing
E Hatch Rd.	Herndon Rd.	Central Ave.	I	0.94	Existing		Existing
E Service Rd.	Blaker Rd.	Central Ave.	II	0.51	Existing		Existing
E Whitmore Ave.	Ceres City Limits	Mitchell Rd.	III	2.53	Existing		Existing
Fowler Rd.	Glen Ridge Dr.	Glen Harbor Dr.	II	0.08	Existing		Existing
Fowler Rd.	Moffett Rd.	Mitchell Rd.	III	0.50	Existing		Existing
Helen Perry Rd.	Boothe Rd.	School Parking Lot	II	0.13	Existing		Existing
Lunar Dr.	Fowler Rd.	E Whitmore Ave.	III	0.45	Existing		Existing
Richland Ave.	River Rd.	Nadine Ave.	II	0.53	Existing		Existing
Rose Ave.	Galsgow Dr.	Roeding Rd.	III	1.42	Existing		Existing
W Whitmore Ave.	S Carpenter Rd.	Ceres City Limits	III	2.11	Existing		Existing
		Total Existing		13.60			
10th St.	Roeding Rd.	Don Pedro Rd.	II	0.25	Proposed		\$7,100
6th St.	E Whitmore Ave.	Park St.	II	0.42	Proposed		\$11,900
Blaker Rd.	E Whitmore Ave.	Ceres City Limits	II	1.60	Proposed		\$45,000
Boothe Rd.	Rhone Dr.	Just North of Whitehaven Ave.	II	0.39	Proposed		\$11,100
Bystrum Rd.	River Rd.	Joyce Ave.	II	1.21	Proposed		\$34,200
Canal	Blaker Rd.	Mitchell Rd.	I	1.56	Proposed		\$1,298,200
Canal	Crows Landing Rd.	Blaker Rd.	I	1.52	Proposed		\$1,264,300
Central Ave.	E Service Rd.	Pine St.	II	0.38	Proposed		\$10,700
Central Ave.	River Rd.	SR 99	II	0.17	Proposed		\$4,800
Crows Landing Rd.	E Service Rd.	Crows Landing Rd.	II	0.51	Proposed	16A	\$14,300
E Hatch Rd.	Eastgate Blv.	Faith Home Rd.	I	0.35	Proposed		\$290,100
E Hatch Rd.	Mitchell Rd.	Charlottesville Ln.	I	0.14	Proposed		\$118,800
E Service Rd.	Central Ave.	Moore Rd.	II	1.15	Proposed		\$32,300
E Service Rd.	Crows Landing Rd.	Blaker Rd.	II	1.51	Proposed		\$42,700
E Whitmore Ave.	Ceres City Limits	Faith Home Rd.	II	1.00	Proposed		\$28,200
El Camino	E Whitmore Ave.	E Service Rd.	II	1.43	Proposed		\$40,300
Fowler Rd.	Glen Harbor Dr.	Boothe Rd.	II	0.30	Proposed		\$8,400
Fowler Rd.	Mitchell Rd.	Glen Ridge Dr.	II	0.03	Proposed		\$1,000

Segment Name	From	To	Bikeway Class	Length (Miles)	Status	Primary Segment	Cost
Giddings St.	Paramount Ave.	Richland Ave.	II	0.21	Proposed		\$5,900
Glasgow Dr.	Central Ave.	Moffett Rd.	II	0.50	Proposed		\$14,000
Grand View Ave.	Herndon Rd.	Paramount Ave.	II	0.21	Proposed		\$6,000
Hackett Rd.	Morgan Rd.	Central Ave.	II	1.01	Proposed		\$28,500
Helen Perry Rd.	School Parking Lot	Clarendon Ct.	II	0.45	Proposed		\$12,600
Herndon Rd.	Joyce Ave.	E Whitmore Ave.	II	1.46	Proposed		\$41,000
Herndon Rd.	River Rd.	Herndon Ct.	III	0.90	Proposed		\$11,400
Joyce Ave.	Bystrum Rd.	Herndon Rd.	II	0.09	Proposed		\$2,500
Magnolia St.	Central Ave.	Moffett Rd.	III/II	0.50	Proposed		\$14,000
Magnolia St.	Moffett Rd.	Rose Ave.	II	0.28	Proposed		\$7,900
Mitchell Rd.	Class I	River Rd.	I	0.25	Proposed		\$207,200
Mitchell Rd.	River Rd.	E Hatch Rd.	II	0.35	Proposed		\$9,900
Moffett Rd.	River Rd.	E Whitmore Ave.	II	1.50	Proposed		\$42,400
Moore Rd.	E Hatch Rd.	Service Rd.	I	2.00	Proposed		\$1,670,800
Morgan Rd.	E Whitmore Ave.	Ceres City Limits	II	1.60	Proposed		\$45,100
Paramount Ave.	Giddings St.	Grand View Ave.	II	0.03	Proposed		\$900
Pine St.	Central Ave.	6th St.	II	0.38	Proposed		\$10,800
Richard Wy.	Richland Ave.	Central Ave.	II	0.50	Proposed		\$14,200
Richland Ave.	Nadine Ave.	SR 99	II	0.89	Proposed		\$25,000
River Rd.	Central Ave.	Mitchell Rd.	II	1.27	Proposed		\$35,700
Roeding Rd.	10th St.	Rose Ave.	II	0.15	Proposed		\$4,200
		Total Proposed		28.44			\$5,473,400



STANCOG NMTMP - CERES

Figure 4-4: Ceres Existing and Proposed Bikeway Network

4.7. City of Hughson

Planning and Policy Context

The following summarizes past planning efforts and establishes a policy framework to guide future transportation decisions and capital improvement programming. This undertaking is intended to promote regional planning, offer opportunities to coordinate infrastructure improvements, and to incorporate past planning efforts into the Current Plan.

Hughson General Plan (2005)

The General Plan's Land Use, Circulation, and Conservation Elements include goals and policies to provide pedestrian and bicycle facilities. Policies in the Land Use Element require that new development provide pedestrian and bicycle connections. The Circulation element states that there is a need in the City for additional bicycle facilities and planning. The Circulation element also includes policies promoting a connected street pattern with multiple route options for bicycles and pedestrians, promoting narrow local streets, discouraging dead-end cul-de-sacs, and connecting local bicycle and pedestrian routes to larger regional systems. The Conservation Element notes that the City is currently working to develop a recreational corridor in and around Hughson that would include linear parks, and bicycle and pedestrian trails.

Hughson Street Master Plan (2007)

The Street Master Plan includes Street Design Guidelines outlining a 5 foot minimum sidewalk and 5 foot landscape strip for all street types, with the exception of local residential streets, which may not have a landscape strip. Other exceptions include Downtown Collectors, which are required to have 12 foot sidewalks, and some expressways, which are required to have a 7 foot minimum sidewalk. The Master Plan also recommends that the City develop a bicycle master plan.

Hughson Traffic Impact Analysis Guidelines (2007)

The Hughson Traffic Impact Analysis Guidelines outline the procedures and standards to be used for Traffic Impact Studies in the City of Hughson. The components of a Traffic Impact Study include a summary of existing or planned bicycle and pedestrian facilities that may be affected by the project, discussion of bicycle and pedestrian access requirements and the adequacy of on-site bicycle and pedestrian circulation, as well as a description of the project's potential effect on bicycle and pedestrian facilities, safety, and demand.

Hughson Design Expectations

The Design Expectations include principles to encourage pedestrian activity and provide a pedestrian-scale streetscape. These include pedestrian oriented residential neighborhoods with mixed uses and open space, and interconnected street systems with pedestrian and bicycle facilities. Specific policies and design guidance is provided to meet the expectations. For example, avoiding dead-end cul-de-sacs lacking pedestrian and/or bicycle access to adjoining streets or public areas, providing Class III Bikeways on all collector streets, and providing pedestrian sidewalks or pathways on both sides of all streets (local residential, collector and arterial).

Hughson Non-Motorized Master Plan (March 2008 Draft)

The Draft Hughson Non-Motorized Master Plan outlines recommendations for specific pedestrian and bicycle improvements within the City. Pedestrian improvements in the Plan include ten sidewalk projects to address sidewalk gaps and railroad crossing improvements. Other pedestrian elements include recommendations for pedestrian friendly design as well as decision flow charts for uncontrolled crosswalk design. Bicycle improvements proposed in the plan include extending the network from 0.85 miles to over 25 miles of bikeways. The proposed network would connect destinations such as Hughson's neighborhoods with downtown, other commercial centers, industrial areas, and parks. The majority of the proposed bikeways are Class II facilities. The Draft Non-Motorized

Transportation plan also proposes recommended steps for bicycle and pedestrian education programs for City residents.

Existing Conditions

Located East of Santa Fe Avenue, Hughson is a city just over one square mile housing about 6,100 people. Hughson has two north-south Class II bikeways totaling less than one mile in length.

Proposed Improvements

Proposed Class I facilities in Hughson include the extension of the Hatch Road path from Ceres to Geer Road, and a north-south path on Geer Road (outside the City limits).

A major cross-town Class II route is proposed along Whitmore Avenue between Baldwin Road and east of Geer Road. No Class III bicycle routes are proposed in Hughson.

Table 4-4 and Figure 4-5 include details for the Hughson bikeway network.

Table 4-4: Hughson Existing and Proposed Bikeway Network

Segment Name	From	To	Bikeway Class	Length (Miles)	Status	Primary Segment	Cost
6th St.	Fox Rd.	E Whitmore Ave.	II	0.50	Existing		Existing
Charles St.	Fox Rd.	Hughson Ave.	II	0.36	Existing		Existing
		Total Existing		0.86			
A St.	Euclid Ave.	End of A St.	II	0.08	Proposed		\$2,200
Charles St.	Fox Rd.	Prelude Ln.	III	0.36	Proposed		\$4,500
Charles St.	Hughson Ave.	S Santa Fe Ave.	II	0.25	Proposed		\$7,200
Class III Connector	NW End of Flora Vista Dr.	Proposed Class II	III	0.20	Proposed		\$2,600
Ester Marie Ave.	Flora Vista Dr.	Fox Rd.	III	0.04	Proposed		\$500
Flora Vista Dr.	NW End of Flora Vista Dr.	Ester Marie Ave.	III	0.34	Proposed		\$4,300
Fox Rd.	Ester Marie Ave.	Tully Rd.	III	0.23	Proposed		\$2,900
Hughson Ave.	S Santa Fe Ave.	7th St.	II	0.42	Proposed		\$12,000
Locust St.	Orchard Ln.	Euclid Ave.	III	0.16	Proposed		\$2,000
Locust St.	Tully Rd.	Mariposa Dr.	III	0.81	Proposed		\$10,200
Orchard Ln.	Thomas Taylor Dr.	Locust St.	III	0.08	Proposed		\$1,000
Proposed Class I	Mariposa Dr.	Orchard Ln.	I	0.10	Proposed		\$81,200
Proposed Class II	E Hatch Rd.	S Santa Fe Ave.	II	0.25	Proposed		\$7,200
Thomas Taylor Dr.	Morgan Lynn Ln.	Orchard Ln.	III	0.59	Proposed		\$7,500
Tully Rd.	E Hatch Rd.	Fox Rd.	III	0.50	Proposed		\$6,300
		Total Proposed		4.42			\$151,600



STANCOG NMTMP - HUGHSON

Figure 4-5: Hughson Existing and Proposed Bikeway Network

4.8. City of Modesto

Planning and Policy Context

The following summarizes past planning efforts and establishes a policy framework to guide future transportation decisions and capital improvement programming. This undertaking is intended to promote regional planning, offer opportunities to coordinate infrastructure improvements, and to incorporate past planning efforts into the Current Plan.

Modesto General Plan (1995, with amendments in 2003)

The General Plan includes non-motorized transportation in a few key areas. One of the overall goals behind the plan is to encourage alternatives to the drive-alone mode, such as bicycling and trail systems to reduce traffic congestion and enhance air quality. The Plan includes design principles so that housings, jobs, and daily needs are within easy walking distance of each other; and locating activities within easy walking distance of transit stops; and providing streets, pedestrian paths, and bicycle paths to create fully connected and interesting routes to all destinations. The Plan also includes street type descriptions, which state that principal arterials should not have bicycle lanes, but minor arterials and collector streets can include bicycle lanes.

The General Plan circulation and transportation policies include reference to non-motorized transportation as well. Development should be designed in a way that will encourage walking as an alternative mode to the automobile for transportation. Safe and convenient pedestrian facilities should be provided in residential, commercial, and other areas when necessary. The use of the bicycle shall be promoted as an alternative mode of transportation. An adequate and safe bicycle system should be provided to connect residential areas with shopping and employment areas. Right of way for bicycle usage should be considered in the planning of new streets and in street improvements. Facilities for mode transfer from bicycle to park and ride lots, transit, and rail should be considered and provided when necessary.

Modesto Non-Motorized Transportation Master Plan (first adopted in 1996; updated in 2006)

The Non-Motorized Transportation Master Plan includes an evaluation of existing bicycle and pedestrian conditions, suggestions for improvements, maps of existing and proposed bicycle facilities, and design guidelines for design guidelines for Class I, II, and III facilities as well as undercrossings, treatments at intersections, signage and pavement marking, and bicycle parking. It also recommends the addition of bicycle parking requirements to the City's zoning ordinance. It reviews and reaffirms the ten goals of the 1996 Plan. The goals of the 1996 Plan are as follows:

1. Continue developing a Citywide non-motorized transportation system that serves alternatives to motorized transportation:
2. Coordinate Modesto's non-motorized transportation system with the systems of neighboring cities and the County.
3. Link the City's non-motorized transportation users to major destinations.
4. Establish a regular maintenance and hazard removal program to ensure safe and well-maintained non-motorized transportation facilities.
5. Continue and expand programs that provide and encourage support facilities for non-motorized transportation users.
6. Continue to establish policies encouraging new development patterns that support non-motorized transportation, such as the village concept.
7. Establish strong transit connections for those who use non-motorized transportation, and to accommodate their particular needs on public transit (i.e. bicycle racks on buses).

8. Work with irrigation districts, railroads and other owners of linear right-of-way that have the potential to accommodate non-motorized transportation facilities and thereby to strengthen the City's non-motorized transportation system.
9. Establish a comprehensive program of community education and feedback related to non-motorized ways of getting about.
10. Seek regular, dedicated local funding for developing the Modesto Non-Motorized Transportation Master Plan, and establish a program to seek regular State and other public development and maintenance funding as available.

Modesto Standards and Specifications (2006)

The Modesto Standards and Specifications Chapter 3, "Street Design," describes requirements for materials and design of all street improvements. Sidewalks, curb treatments, and ramps are covered thoroughly, and a detail is included for a walk-through cul-de-sac. Details for collector streets and minor arterials show bike lane striping, which "shall be installed unless otherwise instructed by the city traffic engineer." The Downtown Streetscape details state that pedestrian bulb-outs should be used at key intersections and at mid-block crosswalks when appropriate street furnishing should be encouraged. Bicycle racks are recommended at a maximum of four per block face and benches are recommended at two per block face.

Existing Conditions

Modesto is located along Highway 99 in the near center of the Stanislaus County. The City is comprised of 36 square miles and has a population of 190,000. Modesto has diverse development, consisting of low- to medium-density residential, commercial and office space, and some industrial land uses. Outside of the urbanized area, agricultural land uses dominate; some of the region's top commodities include dairy products, almonds, apricots, melons, tomatoes, wine grapes, peaches, walnuts and poultry products. Due to its location on the valley floor, the topography in Modesto is generally flat.

Modesto has nearly 70 miles of bikeways. The majority of the bikeways are Class III facilities spread throughout the city providing both north-south and west-east connections. A Class I bike path runs along Dry Creek.

Proposed Improvements

Proposed Class I facilities in Modesto include east-west paths across the city along Pelandale Avenue; along Briggsmore Avenue between Coffee Road and Claus Road; along State Route 132 between Dakota Avenue and Downtown; and along the Tuolumne River between Paradise Road and the existing path at Tioga Drive. Proposed north-south paths include a facility along the railroad corridor adjacent to North 9th Street between Kiernan Avenue and Hatch Road; along Carpenter Road between State Route 132 and Whitmore Avenue; along the railroad corridor adjacent to Grinell Avenue and Yukon Drive between Kiernan Avenue and Downtown; and along Claus Road between Kiernan Avenue and State Route 132.

Class II bike lanes are proposed on roadways on the west side of Modesto including Nebraska Avenue, Blue Gum Avenue and North Carpenter Road. These will connect to proposed bike lanes into the downtown area including Paradise Road, California Avenue and Needham Avenue. Additionally, Class II bike lanes are proposed in the north connecting Modesto and Riverbank on Coffee Road, Oakdale Road and Roselle Avenue. A system of bike lanes is also proposed in the residential area near Floyd Avenue, Roselle Avenue, Merle Avenue and Sylvan Avenue.

Class III bicycle routes are proposed throughout the city of Modesto to provide connections to existing and proposed Class I and Class II facilities and to provide cross-town routes. These include 11th Street, 12th Street, 14th Street, G Street and H Street through the downtown area. Other major roadways proposed as bike routes include Carver Road, Snyder Avenue, South Emerald Avenue, Floyd Avenue, Miller Avenue, Finch Road and Robertson Road.

Table 4-5 and Figure 4-6 include details for the Modesto bikeway network.

Table 4-5: Modesto Existing and Proposed Bikeway Network

Segment Name	From	To	Bikeway Class	Length (Miles)	Status	Primary Segment	Cost
Athens Ave.	Bodega Ln.	Coffee Rd.	III	0.24	Existing		Existing
Beyer Park Dr.	Modesto City Limits	Sylvan Ave.	III	0.78	Existing		Existing
Bodega Ln.	Athens Ave.	Tokay Ave.	III	0.11	Existing		Existing
Bronson Ave.	W Granger Ave.	Pearl St.	III	0.12	Existing		Existing
Celeste Dr.	Coffee Rd.	Rose Ave.	III	0.50	Existing		Existing
Center St.	Roselawn Ave.	Sunset Blv.	III	0.13	Existing		Existing
Chrysler Dr.	Park Pl.	Prescott Rd.	III	0.33	Existing		Existing
Class I Along Canal	Sisk Rd.	Semallon Dr.	I	2.67	Existing		Existing
Claus Rd.	E Orangeburg Ave.	Creekwood Dr.	I	0.94	Existing		Existing
Coffee Rd.	Modesto City Limits	Dry Creek	II	3.62	Existing		Existing
College Ave.	W Rumble Rd.	Ulrich Ave.	III	1.50	Existing		Existing
Collier Ave.	E Orangeburg Ave.	E Roseburg Ave.	III	0.25	Existing		Existing
Dry Creek	La Loma Ave.	Claus Rd.	I	4.24	Existing		Existing
E Orangeburg Ave.	Coffee Rd.	Claus Rd.	III	2.98	Existing		Existing
E Roseburg Ave.	Carver Rd.	Sunrise Ave.	III	2.04	Existing		Existing
Eastridge Dr.	Laramie Dr.	Surrey Ave.	III	0.22	Existing		Existing
Encina Ave.	Dry Creek	N Riverside Dr.	III	1.88	Existing		Existing
Evergreen Ave.	W Briggsmore Ave.	Grape Ave.	III	0.44	Existing		Existing
Floyd Ave.	Keller St.	Rose Ave.	III	0.18	Existing		Existing
Grape Ave.	Evergreen Ave.	Pearl St.	III	0.09	Existing		Existing
Keller St.	Sylvan Ave.	Floyd Ave.	III	0.75	Existing		Existing
Kimble St.	Lucern Ave.	Downey Ave.	III	0.51	Existing		Existing
La Loma Ave.	Downey Ave.	Santa Barbara Ave.	III	0.89	Existing		Existing
Laramie Dr.	Eastridge Dr.	Lillian Dr.	III	0.66	Existing		Existing
Leveland Ln.	College Ave.	Mc Henry Ave.	III	0.61	Existing		Existing
Locke Rd.	Sunnyside Ave.	Rose Ave.	III	0.37	Existing		Existing
Lucern Ave.	Kimble St.	Sunnyside Ave.	III	0.87	Existing		Existing
Magnolia Ave.	W Orangeburg Ave.	Needham Ave.	III	1.25	Existing		Existing
Mc Guire Dr.	E Orangeburg Ave.	Surrey Ave.	III	0.50	Existing		Existing
Mills Ave.	Ulrich Ave.	Harvard Ave.	III	0.56	Existing		Existing
Mount Vernon Dr.	Prescott Rd.	College Ave.	III	1.38	Existing		Existing
Myrtle Ave.	Mills Ave.	Stoddard Ave.	III	0.37	Existing		Existing
N Carpenter Rd.	Blue Gum Ave.	Cummins Dr.	II	0.13	Existing		Existing
Oakdale Rd.	Wylie Dr.	Surrey Ave.	III	0.11	Existing		Existing
Pearl St.	Grape Ave.	Bronson Ave.	III	1.00	Existing		Existing
Phoenix Ave.	Edgebrook Dr.	Encina Ave.	III	0.30	Existing		Existing
Prescott Rd.	Canal	W Orangeburg Ave.	II	1.42	Existing		Existing
Princeton/Hintze/Fairmont	Carver Rd.	Coffee Rd.	III	2.67	Existing		Existing
Rose Ave.	Floyd Ave.	Locke Rd.	III	1.66	Existing		Existing
Roselawn Ave.	Center St.	South Ave.	III	0.36	Existing		Existing
Rosina Ave.	Encina Ave.	Haddon Ave.	III	0.27	Existing		Existing
Santa Barbara Ave.	Encina Ave.	Yosemite Blv.	III	0.48	Existing		Existing
Scenic Dr.	Sonoma Ave.	Wycliffe Dr.	III	1.02	Existing		Existing
Semallon Dr./Amber St.	Canal	Standiford Ave.	III	0.61	Existing		Existing

Segment Name	From	To	Bikeway Class	Length (Miles)	Status	Primary Segment	Cost
Sherwood Ave.	Standiford Ave.	W Orangeburg Ave.	III	1.90	Existing		Existing
Standiford Ave.	Dale Rd.	Mc Henry Ave.	II	3.15	Existing		Existing
Stoddard Ave.	Madonia Ave.	Magnolia Ave.	III	0.79	Existing		Existing
Sunnyside Ave.	Locke Rd.	Lucern Ave.	III	0.09	Existing		Existing
Sunrise Ave.	E Roseburg Ave.	E Fairmont Ave.	III	0.19	Existing		Existing
Sunset Blv.	Sierra Dr.	Center St.	III	0.12	Existing		Existing
Surrey Ave.	Oakdale Rd.	Eastridge Dr.	III	0.74	Existing		Existing
Sylvan Ave.	Mc Henry Ave.	Oakdale Rd.	II	1.99	Existing		Existing
Tokay Ave.	Mc Henry Ave.	Bodega Ln.	III	0.75	Existing		Existing
Tully Rd.	Pelandale Ave.	Coldwell Ave.	II	3.27	Existing		Existing
Tuolomne River	Tioga Dr.	Mitchell Rd.	I	1.75	Existing		Existing
Ulrich Ave.	W Rumble Rd.	Mills Ave.	III	0.12	Existing		Existing
Veneman Ave.	Dale Rd.	Sash Ct.	III	0.72	Existing		Existing
W Fairmont Ave.	Enslin Ave.	Magnolia Ave.	III	0.22	Existing		Existing
W Granger Ave.	Bronson Ave.	Sunrise Ave.	III	1.13	Existing		Existing
W Orangeburg Ave.	Evergreen Ave.	Coffee Rd.	II	3.14	Existing		Existing
W Rumble Rd.	E Rumble Rd.	Oakdale Rd.	III	0.31	Existing		Existing
W Rumble Rd.	Sisk Rd.	Hashem Dr.	III	4.81	Existing		Existing
Woodbine Dr.	Lillian Dr.	Glenbrook Wy.	III	0.54	Existing		Existing
Wylie Dr.	Rose Ave.	Oakdale Rd.	III	0.50	Existing		Existing
		Total Existing		68.25			
10th St.	E St.	S Morton Blv.	III	0.43	Proposed		\$5,400
11th St.	Needham Ave.	S Morton Blv.	III	1.37	Proposed		\$17,300
12th St.	Needham Ave.	B St.	III	1.10	Proposed		\$13,800
14th St.	Needham Ave.	D St.	III	0.77	Proposed		\$9,700
1st St.	H St.	G St.	III	0.08	Proposed		\$1,000
7th St.	H St.	S 7th St.	III	0.48	Proposed		\$6,100
Alcama Ave.	Houser Ln.	Chicago Ave.	III	0.12	Proposed		\$1,600
Aria Wy.	Sylvan Ave.	Hillglen Ave.	II	0.25	Proposed		\$7,000
Bear Cub Ln.	Hillglen Ave.	Kodiak Dr.	II	0.25	Proposed		\$7,200
Blue Bird Dr.	Snyder Ave.	Nightingale Dr.	III	0.23	Proposed		\$2,900
Blue Gum Ave.	Morse Rd.	Culpepper Ave.	II	1.19	Proposed		\$33,500
Bowen Ave.	Earlmar Dr.	Mc Henry Ave.	III	1.55	Proposed		\$19,500
Bridgewood Wy.	Palmwood Dr.	Oakdale Rd.	III	0.38	Proposed		\$4,700
Budd St.	Conant Ave.	Sharon Wy.	III	0.34	Proposed		\$4,300
Burney St.	Downey Ave.	14th St.	III	0.55	Proposed		\$7,000
Caden Dr.	Hillglen Ave.	Kodiak Dr.	II	0.25	Proposed		\$7,200
California Ave.	S Carpenter Rd.	S Jefferson St.	II	1.19	Proposed		\$33,500
Canal	Coffee Rd.	Held Dr.	I	3.42	Proposed		\$2,854,100
Capistrano Dr.	Pirinen Ln.	Japonica Wy.	III	0.63	Proposed		\$7,900
Carver Rd.	North of Kiernan Ave.	Princeton Ave.	III	4.03	Proposed		\$50,700
Celeste Dr.	Rose Ave.	Oakdale Rd.	III	0.50	Proposed		\$6,300
Chapman Rd.	North of Kiernan Ave.	Pelandale Ave.	III	1.02	Proposed		\$12,800
Chapparal Pl.	Morse Rd.	Rosemore Ave.	III	0.50	Proposed		\$6,300
Chicago Ave.	Canal	Roselawn Ave.	III	1.04	Proposed		\$13,100
Claremont Ave.	Sylvan Ave.	E Rumble Rd.	III	0.63	Proposed		\$7,900

Segment Name	From	To	Bikeway Class	Length (Miles)	Status	Primary Segment	Cost
Claus Rd.	Creekwood Dr.	Yosemite Blv.	I	0.81	Proposed		\$674,100
Claus Rd.	Sylvan Ave.	E Orangeburg Ave.	I	1.76	Proposed		\$1,462,700
Codding Dr.	Floyd Ave.	Tokay Ave.	III	0.43	Proposed		\$5,400
Coldwell Ave.	N 9th St.	Tully Rd.	II	0.34	Proposed		\$9,700
College Ave.	Stoddard Ave.	Needham Ave.	II	0.25	Proposed		\$7,200
Conant Ave.	Veneman Ave.	Sisk Rd.	III	1.17	Proposed		\$14,700
Covena Ave.	Edgebrook Dr.	Yosemite Blv.	III	0.58	Proposed		\$7,400
Crater Ave.	Ustick Rd.	Dallas St.	III	0.58	Proposed		\$7,300
Creekwood Dr.	Norseman Dr.	Yosemite Blv.	III	1.25	Proposed		\$15,700
Crows Landing Rd.	S 7th St.	E Whitmore Ave.	II	2.06	Proposed		\$58,200
Dale Rd.	Kiernan Ave.	Pelandale Ave.	I	0.76	Proposed		\$632,100
Dallas St.	Crater Ave.	W Whitmore Ave.	III	1.11	Proposed		\$13,900
Dragoo Park Dr.	Modesto City Limits	Claremont Ave.	III	1.05	Proposed		\$13,300
Dry Creek	La Loma Ave.	Modesto City Limits	I	1.24	Proposed		\$1,037,300
Dry Creek Dr.	Lincoln Ave.	Creekwood Dr.	III	0.73	Proposed		\$9,200
E Orangeburg Ave.	E Briggsmore Ave.	E Orangeburg Ave.	III	0.46	Proposed		\$5,800
E St.	10th St.	12th St.	III	0.14	Proposed		\$1,800
Edgebrook Dr.	La Loma Ave.	Covena Ave.	III	0.67	Proposed		\$8,500
Edgebrook Dr.	Oakbrook Dr.	El Vista Ave.	III	0.53	Proposed		\$6,700
El Pasado Dr.	N Riverside Dr.	Capistrano Dr.	III	0.31	Proposed		\$3,900
Fine Ave.	Hillglen Ave.	Merle Ave.	II	0.96	Proposed		\$26,900
Floyd Ave.	Mc Henry Ave.	Keller St.	III	1.32	Proposed		\$16,600
Floyd Ave.	Oakdale Rd.	Claus Rd.	II	2.00	Proposed		\$56,300
Floyd Ave.	Rose Ave.	Oakdale Rd.	III	0.50	Proposed		\$6,300
G St.	1st St.	Burney St.	III	1.24	Proposed		\$15,600
Gagos Dr.	Pelandale Ave.	Sisk Rd.	III	0.85	Proposed		\$10,700
Glenbrook Wy.	E Orangeburg Ave.	Springcreek Dr.	III	0.18	Proposed		\$2,300
Grecian Ave.	Erin Wy.	Drakeshire Dr.	III	0.64	Proposed		\$8,000
H St.	Yosemite Ave.	La Loma Ave.	III	1.46	Proposed		\$18,400
Hahn Dr.	Veneman Ave.	W Rumble Rd.	III	0.49	Proposed		\$6,200
Hammond St.	Rouse Ave.	Robertson Rd.	III	0.50	Proposed		\$6,300
Harris Ave.	Chicago Ave.	Rouse Ave.	III	0.38	Proposed		\$4,800
Hashem Dr.	Bridgewood Wy.	E Rumble Rd.	III	0.81	Proposed		\$10,200
Held Dr.	E Briggsmore Ave.	E Orangeburg Ave.	III	0.27	Proposed		\$3,400
Hillglen Ave.	La Force Dr.	Fine Ave.	II	1.75	Proposed		\$49,400
Hillside Dr.	S Santa Cruz Ave.	Tioga Dr.	III	0.49	Proposed		\$6,200
Houser Ln.	Ohio Ave.	Alcama Ave.	III	0.74	Proposed		\$9,300
Janna Ave.	Prescott Rd.	Mount Vernon Dr.	III	0.51	Proposed		\$6,500
Kerr Ave.	Yosemite Blv.	Tioga Dr.	III	0.40	Proposed		\$5,000
Kodiak Dr.	La Force Dr.	Fine Ave.	II	1.73	Proposed		\$48,800
La Force Dr.	Oakdale Rd.	Iron Gate Dr.	II	0.11	Proposed		\$3,100
La Loma Ave.	Santa Barbara Ave.	Yosemite Blv.	III	0.26	Proposed		\$3,300
Lapham Dr.	Empire Ave.	S Riverside Dr.	III	1.10	Proposed		\$13,800
Laramie Dr.	Sonoma Ave.	Eastridge Dr.	III	0.23	Proposed		\$2,900
Las Palmas Ave.	Encina Ave.	Yosemite Blv.	III	0.46	Proposed		\$5,800
Lincoln Oak Dr.	Kodiak Dr.	Merle Ave.	II	0.75	Proposed		\$21,200
Litt Rd.	Modesto City Limits	Sylvan Ave.	II	0.38	Proposed		\$10,700

Segment Name	From	To	Bikeway Class	Length (Miles)	Status	Primary Segment	Cost
Litt Rd.	Sylvan Ave.	Kodiak Dr.	II	0.50	Proposed		\$14,100
Mable Ave.	Coffee Rd.	East Of Oakdale Rd.	III	1.49	Proposed		\$18,800
Maid Mariane Ln.	Sharon Ave.	Merle Ave.	II	0.25	Proposed		\$7,100
Marsala Wy.	Snyder Ave.	Veneman Ave.	III	0.50	Proposed		\$6,400
Maze Blv.	S Carpenter Rd.	5th St.	I	1.30	Proposed		\$1,083,500
Mc Reynolds Ave.	Sylvan Ave.	Hillglen Ave.	II	0.25	Proposed		\$7,100
Mechalys Wy.	N Mc Clure Rd.	Creekwood Dr.	III	0.22	Proposed		\$2,800
Merle Ave.	Oakdale Rd.	Claus Rd.	II	1.99	Proposed		\$56,000
Mid Lateral No. 2	N McClure Rd.	Church St.	I	1.58	Proposed		\$1,313,500
Mid Lateral No. 4	E Briggsmore Ave.	S Dakota Ave.	I	6.13	Proposed		\$5,109,800
Mid Lateral No. 5	Maze Blvd.	Griffin Rd.	I	4.03	Proposed		\$3,361,100
Mid Lateral No. 6	HWY 99	Snyder Ave.	I	2.57	Proposed		\$2,142,000
Mid Lateral No. 7	Synder Ave.	Sylvan Ave.	I	0.66	Proposed		\$547,500
Millbrook Ave.	Sylvan Ave.	Belharbour Dr.	II	1.04	Proposed		\$29,400
Miller Ave.	La Loma Ave.	N Riverside Dr.	III	1.44	Proposed		\$18,100
Modesto City Limits	Roselle Ave.	Litt Rd.	II	0.53	Proposed		\$15,000
Mono Dr.	S Santa Rosa Ave.	Santa Rita Ave.	III	0.09	Proposed		\$1,200
Montclair Dr.	Carver Rd.	Tully Rd.	III	0.54	Proposed		\$6,900
Morgan Rd.	Class I Connector	E Whitmore Ave.	III	0.83	Proposed		\$10,400
Morse Rd.	Blue Gum Ave.	Kansas Ave.	II	1.00	Proposed		\$28,200
N 9th St.	Carver Rd.	Canal	II	1.02	Proposed		\$28,800
N Carpenter Rd.	Cummins Dr.	South of Hillview Dr.	II	1.38	Proposed		\$38,800
N Emerald Ave.	Granite Ln.	California Ave.	III	1.91	Proposed		\$24,100
N Mc Clure Rd.	Canal	Poppypatch Dr.	III	0.54	Proposed		\$6,800
N Santa Fe Ave.	Claus Rd.	E Briggsmore Ave.	I	1.72	Proposed		\$1,431,100
Natchez Wy.	Belharbour Dr.	Merle Ave.	II	0.21	Proposed		\$6,000
Needham Ave.	College Ave.	N Morton Blv.	II	1.21	Proposed		\$34,200
Nightingale Dr.	Blue Bird Dr.	Dale Rd.	III	0.49	Proposed		\$6,200
Norseman Dr.	Creekwood Dr.	South of Creekwood Dr.	III	0.34	Proposed		\$4,300
Oakbrook Dr.	Edgebrook Dr.	Encina Ave.	III	0.14	Proposed		\$1,800
Oakdale Rd.	Merle Ave.	E Briggsmore Ave.	III	0.25	Proposed		\$3,200
Oakdale Rd.	Modesto City Limits	Sylvan Ave.	II	0.20	Proposed		\$5,600
Oakdale Rd.	Sylvan Ave.	Modesto City Limits	II	0.55	Proposed	18	\$15,600
Oaklawn Dr.	Lincoln Oak Dr.	Rampart St.	II	0.86	Proposed		\$24,400
Orchard Park Wy.	Kodiak Dr.	Floyd Ave.	II	0.25	Proposed		\$7,100
Oregon Dr.	S Santa Rosa Ave.	S Conejo Ave.	III	0.66	Proposed		\$8,300
Palmwood Dr.	Sylvan Meadows Dr.	Bridgewood Wy.	III	0.08	Proposed		\$1,000
Panama Dr.	California Ave.	Houser Ln.	III	0.25	Proposed		\$3,200
Paradise Rd.	S Carpenter Rd.	Yosemite Ave.	II	1.52	Proposed		\$42,900
Parallel to SR 99/8th St.	Kiernan Ave.	Tuolumne River	I	7.75	Proposed		\$6,455,000
Pelandale Ave.	Sisk Rd.	Claus Rd.	I	8.07	Proposed		\$6,729,600
Pembroke Dr.	Sheldon Dr.	W Rumble Rd.	III	0.25	Proposed		\$3,100
Penny Ln.	Capistrano Dr.	N Mc Clure Rd.	III	0.68	Proposed		\$8,600
Peppermint Dr.	Oakdale Rd.	Sonoma Ave.	III	0.51	Proposed		\$6,400
Poppypatch Dr.	Capistrano Dr.	N Mc Clure Rd.	III	0.69	Proposed		\$8,600
Prescott Rd.	Snyder Ave.	Canal	II	0.61	Proposed		\$17,100
River Rd.	SR 99	Central Ave.	III	2.42	Proposed		\$30,400

Segment Name	From	To	Bikeway Class	Length (Miles)	Status	Primary Segment	Cost
Robertson Rd.	Ohio Ave.	Sutter Ave.	III	1.31	Proposed		\$16,500
Roselawn Ave.	Sutter Ave.	South Ave.	III	1.01	Proposed		\$12,700
Roselle Ave.	Modesto City Limits	Scenic Dr.	II	2.71	Proposed		\$76,300
Rosemore Ave.	Blue Gum Ave.	Kansas Ave.	III	1.00	Proposed		\$12,600
Rouse Ave.	Harris Ave.	Neece Dr.	III	1.12	Proposed		\$14,100
Royalton Ave.	Montclair Dr.	Sheldon Dr.	III	0.10	Proposed		\$1,300
Rue De Yoe.	Burney St.	N Morton Blv.	III	0.23	Proposed		\$3,000
S 7th St.	C St.	Crows Landing Rd.	II	0.47	Proposed		\$13,200
S 7th St. Parallel	Tuolumne River	Morgan Rd.	I	1.67	Proposed		\$1,393,000
S 9th St.	S Morton Blv.	E Hatch Rd.	II	1.65	Proposed		\$46,700
S Carpenter Rd.	Maze Blvd.	Modesto City Limits	I	2.06	Proposed		\$1,717,700
S Martin Luther King Dr.	Maze Blvd.	Garden Ave.	III	1.71	Proposed		\$21,600
S Morton Blv.	11th St.	Modesto City Limits	III	0.62	Proposed		\$7,800
S Riverside Dr.	Dry Creek	Yosemite Blv.	III	0.74	Proposed		\$9,300
S Santa Cruz Ave.	Yosemite Blv.	Hillside Dr.	III	0.83	Proposed		\$10,400
S Santa Rosa Ave.	Yosemite Blv.	Oregon Dr.	III	0.51	Proposed		\$6,400
San Ignacio Ave.	N Riverside Dr.	Capistrano Dr.	III	0.37	Proposed		\$4,600
Santa Rita Ave.	Mono Dr.	Tenaya Dr.	III	0.12	Proposed		\$1,500
Scenic Dr.	Wycliffe Dr.	Claus Rd.	II	0.52	Proposed		\$14,500
Setrok Dr.	Gagos Dr.	Blue Bird Dr.	III	0.21	Proposed		\$2,700
Shaddox Ave.	Rosemore Ave.	N Emerald Ave.	III	0.74	Proposed		\$9,400
Sharon Ave.	Millbrook Ave.	Fine Ave.	II	0.40	Proposed		\$11,200
Sharon Wy.	Budd St.	Prescott Rd.	III	0.35	Proposed		\$4,400
Shawnee Dr.	Mark Mead Ln.	Sheldon Dr.	III	0.75	Proposed		\$9,500
Sheldon Dr.	Prescott Rd.	Royalton Ave.	III	0.84	Proposed		\$10,600
Shoemake Ave.	Modesto City Limits	SR 99	II	0.46	Proposed		\$13,000
Sisk Rd.	Bangs Ave.	Pelandale Ave.	III	0.39	Proposed		\$4,900
Snyder Ave.	Blue Bird Dr.	Tully Rd.	III	2.56	Proposed		\$32,300
Sonoma Ave.	E Orangeburg Ave.	Scenic Dr.	III	0.76	Proposed		\$9,600
Spring Oak Dr.	Mable Ave.	Bridgewood Wy.	III	0.29	Proposed		\$3,700
Springcreek Dr.	Springcreek Dr.	Scenic Dr.	III	0.19	Proposed		\$2,400
Sunrise Ave.	E Rumble Rd.	E Roseburg Ave.	III	1.59	Proposed		\$20,100
Sylvan Ave.	Oakdale Rd.	Claus Rd.	II	2.00	Proposed		\$56,300
Sylvan Meadows Dr.	Dragoo Park Dr.	Palmwood Dr.	III	1.15	Proposed		\$14,400
Temescal Dr.	Kodiak Dr.	Floyd Ave.	II	0.25	Proposed		\$7,100
Tenaya Dr.	Santa Rita Ave.	S Riverside Dr.	III	1.88	Proposed		\$23,700
TID Lateral No. 1	Dallas St.	S Carpenter Rd.	I	2.03	Proposed		\$1,688,300
Tioga Dr.	Kerr Ave.	Tuolumne River	III	0.83	Proposed		\$10,500
Tully Rd.	Coldwell Ave.	SR 99	II	0.34	Proposed		\$9,700
Tuolomne River	Modesto City Limits	Tioga Dr.	I	5.32	Proposed		\$4,435,100
Ustick Rd.	Crater Ave.	W Whitmore Ave.	III	0.83	Proposed		\$10,400
Virginia Ave.	W Morris Ave.	Needham Ave.	II	0.39	Proposed		\$10,900
Virginia Railroad Trail	Claribel Rd.	N 9th St.	I	4.63	Proposed		\$3,859,900
W Hatch Rd.	Dallas St.	Crows Landing Rd.	II	0.41	Proposed		\$11,500
W Hatch St.	Crows Landing Rd.	Herndon Rd.	I	1.06	Proposed		\$887,000
W Union Ave.	Tully Rd.	Dragoo Park Dr.	III	1.54	Proposed		\$19,300
Wood Sorrel Dr.	Sylvan Ave.	Hillglen Ave.	II	0.25	Proposed		\$7,000

Segment Name	From	To	Bikeway Class	Length (Miles)	Status	Primary Segment	Cost
Woodland Ave.	N Carpenter Rd.	N 9th St.	II	0.70	Proposed		\$19,700
		Total Proposed		172.44			\$50,832,600

This page intentionally left blank

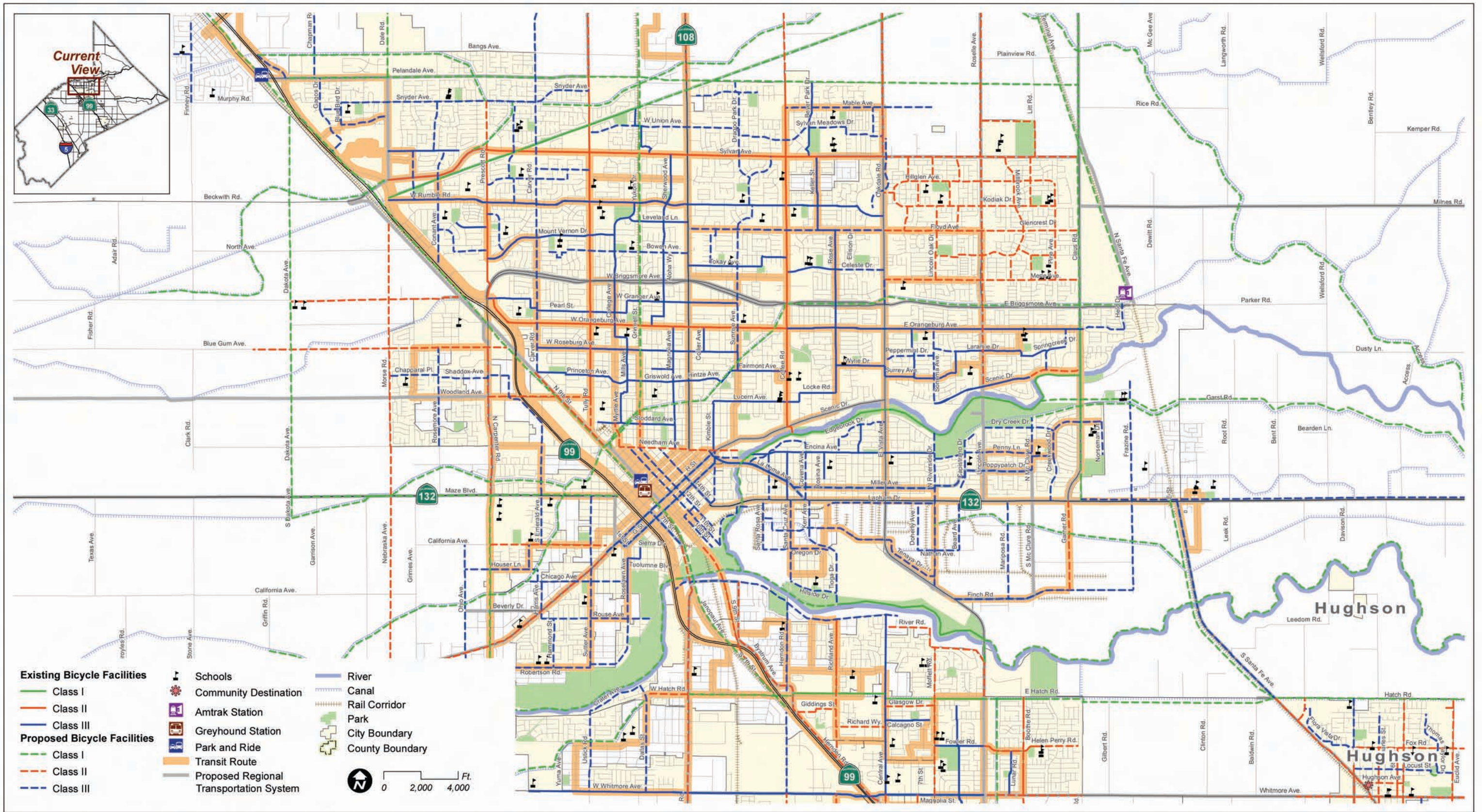

Figure 4-6: Modesto Existing and Proposed Bikeway Network

4.9. City of Newman

Planning and Policy Context

The following summarizes past planning efforts and establishes a policy framework to guide future transportation decisions and capital improvement programming. This undertaking is intended to promote regional planning, offer opportunities to coordinate infrastructure improvements, and to incorporate past planning efforts into the Current Plan.

Newman 2030 General Plan (2006)

The Vision Statement asserts that “Newman will be a walkable community, with a well-connected street grid, pedestrian amenities and bike lanes...A network of pedestrian trails and bike paths will connect residents to parks, schools, downtown and other destinations.” Accordingly, Master Plans for sub-areas containing residential land uses are required to include these features. The Transportation and Circulation Element includes a thorough discussion of the existing conditions of the pedestrian and bicycle networks in Newman. The Community Design Element lists Pedestrian Orientation as one of the urban design principles which characterize Newman, and should shape future growth. Goals, policies and actions throughout the General Plan emphasize the importance of pedestrian and bicycle facilities in the city’s circulation network.

Newman City Code

The Newman City Code includes provisions for bicycle parking which state, “each parking area associated with any type of land use, except single-family and two-family residential dwellings, shall provide a number of bicycle parking spaces with secured bicycle racks.” The number of bicycle parking spaces required is based on the number of vehicle parking spaces, and ranges from 0 (if there are 1-4 vehicle parking spaces), to 10 (if there are 400 or more vehicle parking spaces).

Existing Conditions

Located on the southern border of the County and bisected by Highway 33, Newman is small city comprised of 1.4 square miles and a population of 7,000. The north western portion of the city is laid out in a grid pattern. The south western and eastern portions of the city have a loop street pattern and many cul-de-sacs. Connections across Highway 33 and the rail line are limited. Newman has over four miles of bikeways. The majority of the bikeways are Class II on-street facilities in the north east portion of the City including on Balsam Drive, Driskell Avenue, and Yolo Street. A Class I bike path runs along Sherman Parkway.

Proposed Improvements

Proposed Class I facilities near and in Newman include paths on Harvey Road between Sherman Parkway and Shiells Road, on Shiells Road between Harvey Road and Canal School Road, and on Canal School Road between Shiells Road and Hills Ferry Road. Outside of the City limits, proposed paths include a north-south path along the canal west of the City, connecting to an east-west path south of Hallowell Road, and continuing northwest, with a path connecting to Hills Ferry Road.

Class II bike lanes are proposed on many of Newman’s major cross-town roads, including Draper Road, Upper Road, Fig Lane/Q Street, Prince Street, Stuhr Road, Hoyer Road/Inyo Avenue, and Hallowell Road.

No Class III bicycle routes are proposed in Newman.

Table 4-6 and **Figure 4-7** include details for the Newman bikeway network.

Table 4-6: Newman Existing and Proposed Bikeway Network

Segment Name	From	To	Bikeway Class	Length (Miles)	Status	Primary Segment	Cost
Balsam Dr.	Sherman Pkwy.	Kern St.	II	0.62	Existing		Existing
Canyon Creek Dr.	Harvey Rd.	Upper Rd.	II	0.50	Existing		Existing
Driskell Ave.	M St.	Hills Ferry Rd.	II	0.60	Existing		Existing
Kern St.	T St.	L St.	II	0.10	Existing		Existing
Sherman Pkwy.	SR 99	Hills Ferry Rd.	I	1.35	Existing		Existing
T St.	E Orestimba Rd.	Merced St.	II	0.47	Existing		Existing
Yolo St.	Hardin St.	Scott Rd.	II	0.51	Existing		Existing
		Total Existing		4.15			
Barrington Ave.	Sherman Pkwy.	Driskell Ave.	II	0.52	Proposed		\$14,700
Canal School Rd.	Hills Ferry Rd.	E Inyo Ave.	I	0.46	Proposed		\$379,800
Canyon Creek Dr.	Upper Rd.	Prince St.	II	0.49	Proposed		\$13,900
Eucalyptus Ave.	Sherman Pkwy.	Driskell Ave.	II	0.53	Proposed		\$15,000
Fig Ln.	Newman City Limits	Fig Ln.	II	0.98	Proposed		\$27,600
Hoyer Rd.	Newman City Limits	Upper Rd.	II	0.26	Proposed		\$7,300
Inyo Ave.	T St.	Canal School Rd.	II	1.10	Proposed		\$31,000
Kern St.	T St.	L St.	II	0.56	Proposed		\$15,700
Merced St.	Upper Rd.	Driskell Ave.	II	1.35	Proposed		\$38,200
Orestimba Rd.	Newman City Limits	Hardin Rd.	II	0.21	Proposed		\$5,900
Prince St.	Inyo Ave.	Newman City Limits	II	0.51	Proposed		\$14,300
South City Limits	Harvey Rd.	Canal School Rd. Extension	I	1.76	Proposed		\$1,464,700
SR 33	Newman City Limits	Newman City Limits	I	1.63	Proposed		\$1,359,800
T St.	Merced St.	Inyo Ave.	II	0.04	Proposed		\$1,200
Upper Rd.	Hoyer Rd.	Newman City Limits	II	0.51	Proposed		\$14,300
		Total Proposed		10.91			\$3,403,400



STANCOG NMTMP - NEWMAN

Figure 4-7: Newman Existing and Proposed Bikeway Network

4.10. City of Oakdale

Planning and Policy Context

The following summarizes past planning efforts and establishes a policy framework to guide future transportation decisions and capital improvement programming. This undertaking is intended to promote regional planning, offer opportunities to coordinate infrastructure improvements, and to incorporate past planning efforts into the Current Plan.

Oakdale General Plan (1993, with updates in 2002)

Oakdale's General Plan includes a section describing the "Bicycle and Pedestrian System." This section states that "as a result of congestion management requirements, commuter bike activity will need to be promoted." Existing and planned bike facilities are provided, and standard lane design street cross-sections are included. Bicycle, pedestrian and multi-purpose trails "should be distinguished where practical from the bicycle route system, which is largely associated with the roadway system." Several policies in the Transportation chapter promote the construction of pedestrian and recreational facilities such as policies requiring the provision of safe pedestrian access, bicycle parking at commercial development, and the linkage of parks, schools and employment with bicycle and pedestrian paths.

The General Plan has been revised to reference an Oakdale Bicycle and Pedestrian Master Plan. Policy 89a states that future development should implement the Bicycle and Pedestrian Master Plan "where feasible," and the map of proposed bikeways and multi-use trails is included in Chapter 4, "Open Space and Conservation." The Open Space and Conservation Plan of the General Plan identifies a 12 mile Class I bikeway around the perimeter of the City.

Oakdale Bicycle and Pedestrian Master Plan (2006)

The Oakdale City Bicycle and Pedestrian Master Plan provides the City with a blueprint for direction of bicycle and pedestrian facilities. The goals of the plan include a well-connected bikeway system that is safe and convenient for travel within the City as well as travel to other Stanislaus Communities. Policies of the Plan include the provision for and maintenance of bicycle parking, lockers and showers at appropriate locations, as well as the incorporation of signing to ensure safety. As in the Open Space and Conservation Plan, this Plan also addresses the proposed 12 mile perimeter bikeway and proposes identifies needs along certain corridors in order to achieve implementation.

Oakdale City Code

The Oakdale City Code includes a bicycle parking requirement for amusement parks at a rate of one bicycle space for every two amusement game machines. The code also describes limited bicycle parking on E Street.

Oakdale Single Family and Multifamily Residential Design Expectations (2003)

Oakdale's Design Expectations for both Single and Multifamily Residential development promote pedestrian and bicycle focused design. One design principle states that "streets, pedestrians and bike paths should contribute to a system of fully connected routes to all destination areas adjacent to proposed annexation areas." This principle is applied in Design Expectations stating that "pedestrian sidewalks or pathways [shall be] provided on both sides of all streets (local residential, collector and arterial)," and "Class III Bikeways shall be designed on all collector streets", in addition to a system of Class I trails where possible. Also, designers are cautioned to avoid "the use of dead-end cul-de-sacs lacking pedestrian and/or bicycle access to adjoining streets or public areas." Other design principles address the desire for enhancing pedestrian scale in residential streetscapes and reducing pedestrian-vehicle conflicts.

Specific Plans

Several specific plans (Bridle Ridge, East F Street Corridor, and South Oakdale Industrial) include proposed bicycle and pedestrian facilities and/or guidelines.

Existing Conditions

Located on the north eastern area of the county and intersected by Highways 108 and 120, Oakdale is laid out in a primarily grid pattern. The city is five square miles and home to about 19,300 people. The Stanislaus River winds through the City and nearby lakes offer recreational opportunities. Oakdale has over eight miles of bikeways, of which, nearly five miles are Class II facilities. West-East connections can be found on East G Street, East J Street, as well as Poplar and Walnut Streets. North-South connections are located on North 6th and North Maag Avenues.

Proposed Improvements

Proposed Class I facilities in Oakdale include a north-south path along Crane Road, connecting to an east-west path along the canal on the southern edge of the City; a path along Sierra Road to the east; a north-south path along Valley Home Road northwest of the City; and a series of paths in the northeast part of the City, extending out to North Stearns Road.

Class II bike lanes are proposed on two of Oakdale's major east-west corridors: West J Street (connecting to existing bike lanes on East J Street), and West Greger Street, between Crane Road and Albers Road. Class II lanes are also proposed on 1st Avenue and A Street as well as in the southeast part of town along Sierra Road, Post Avenue and High Tech Parkway.

Several Class III bicycle routes are proposed in Oakdale including along State Route 120, on A Street, G Street, Pontiac St, River Avenue, River Bluff Drive and Old Stockton Road.

Table 4-7 and Figure 4-8 include details for the Oakdale bikeway network.

Table 4-7: Oakdale Existing and Proposed Bikeway Network

Segment Name	From	To	Bikeway Class	Length (Miles)	Status	Primary Segment	Cost
Class I Connector	Class II Proposed	SR 108/120	I	0.12	Existing		Existing
E A St.	N 1st Ave.	Old Stockton Rd.	III	0.26	Existing		Existing
E D St.	N 6th Ave.	N Maag Ave.	III	0.76	Existing		Existing
E G St.	S 6th Ave.	S Maag Ave.	II	0.78	Existing		Existing
E J St.	N Maag Ave.	Oakdale City Limits	II	0.16	Existing		Existing
E J St.	S Yosemite Ave.	S Maag Ave.	II	0.91	Existing		Existing
N 1st Ave.	W A St.	E E St.	III	0.36	Existing		Existing
N 6th Ave.	E A St.	E D St.	II	0.27	Existing		Existing
N 6th Ave.	E F St.	E J St.	II	0.36	Existing		Existing
N Maag Ave.	Burchell Hill Dr.	E J St.	II	1.01	Existing		Existing
N Oak Ave.	Walnut St.	Poplar St.	III	0.25	Existing		Existing
Parallel to E D St.	E C St.	N Maag Ave.	I	0.52	Existing		Existing
Poplar St.	Oakdale City Limits	N 1st Ave.	III	0.95	Existing		Existing
S Yosemite Ave.	E J St.	Warnerville Rd.	II	1.06	Existing		Existing
Walnut St.	Oakdale City Limits	N 1st Ave.	III	0.72	Existing		Existing
Warnerville Rd.	S Yosemite Ave.	Park Entrance	II	0.35	Existing		Existing
		Total Existing		8.86			
Ackley Ci.	All	All	II	0.47	Proposed		\$13,100

Segment Name	From	To	Bikeway Class	Length (Miles)	Status	Primary Segment	Cost
Ackley Ct.	Ackley Ci. Connector	Ackley Ci.	II	0.08	Proposed		\$2,200
Albers Rd.	Warnerville Rd.	Oakdale City Limits	II	0.67	Proposed		\$19,000
Along City Limits	Irvin Ct.	Existing Class I	I	0.48	Proposed		\$401,500
Branding Iron St.	W Greger St.	Oakdale City Limits	II	0.28	Proposed		\$7,900
Burchell Hill Dr.	Jacob Wy.	N Maag Ave.	III	0.19	Proposed		\$2,400
C St.	Valley View Dr.	Burchell Hill Dr.	III	0.37	Proposed		\$4,600
Canal	Crane Rd.	Kaufman Rd.	I	2.17	Proposed		\$1,807,500
Class I Connector	Irvine Ct.	Stanislaus River	I	0.11	Proposed		\$89,200
Class II Connector	Ackley Ci.	Hi Tech Parkway.	I	0.07	Proposed		\$58,800
Connector	Oakdale City Limits	N Stearns Rd.	I	0.81	Proposed		\$671,300
Connector	Park	Oakdale City Limits	I	0.33	Proposed		\$277,000
Connector	S Willowood Dr.	Hudson Ave.	I	0.42	Proposed		\$347,900
Connector	W Greger St.	Oakdale City Limits	II	0.16	Proposed		\$4,500
Crane Rd.	Stanislaus River	Oakdale City Limits	I	1.72	Proposed		\$1,433,900
E A St.	N 1st Ave.	N 6th Ave.	II	0.37	Proposed		\$10,400
E A St.	N 6th Ave.	Valley View Dr.	III	0.45	Proposed		\$5,600
E F St.	Oakdale City Limits	Willow Glen Ave.	I	0.92	Proposed		\$765,500
E J St.	S 1st Ave.	S Yosemite Ave.	II	0.16	Proposed		\$4,500
Hudson Ave.	Class I Connector	Oakdale City Limits	II	0.23	Proposed		\$6,400
HWY 108 120	N Stearns Road	County Limits	III	6.40	Proposed		\$80,700
Irvin Dr.	Valley View Dr.	Oakdale City Limits	I	0.37	Proposed		\$309,700
Kaufman Rd.	W Greger St.	South of Canal	I	0.21	Proposed		\$171,700
Martingale Dr.	W Greger St.	Oakdale City Limits	II	0.11	Proposed		\$3,100
Messara Ct.	Oakdale City Limits	W Greger St.	II	0.12	Proposed		\$3,500
N 6th Ave.	E D St.	E F St.	II	0.18	Proposed		\$5,200
N Lee Ave.	Poplar St.	Pontiac St.	III	0.24	Proposed		\$3,000
N Maag Ave.	Irvin Ct.	Burchell Hill Dr.	III	0.15	Proposed		\$1,900
N Oak Ave.	Poplar St.	Wood Ave.	III	0.61	Proposed		\$7,700
Park Connector	Ash Ave.	S Oak Ave.	I	0.15	Proposed		\$125,400
Pontiac St.	Oakdale City Limits	N Lee Ave.	III	0.88	Proposed		\$11,100
Post Ave.	Sierra Rd.	Hedberg Wy.	I	0.40	Proposed		\$335,500
Post Rd.	Class I Connector	Hi Tech Parkway.	II	0.30	Proposed		\$8,400
River Ave.	Walnut St.	W North St.	III	0.83	Proposed		\$10,500
River Bluff Dr.	E A St.	Valley View Dr.	III	0.84	Proposed		\$10,600
S 1st Ave.	W North St.	E J St.	II	0.91	Proposed		\$25,700
S Maag Ave.	E J St.	Sierra Rd.	II	0.18	Proposed		\$5,200
S Willowood Dr.	W F St.	Oakdale City Limits	II	0.53	Proposed		\$14,800
Sierra Rd.	Orsi Rd.	East of Wren Rd.	I	1.07	Proposed		\$894,500
Sierra Rd.	Post Ave.	S Maag Ave.	II	0.26	Proposed		\$7,300
Sierra Rd.	S Maag Ave.	Orsi Rd.	I	0.20	Proposed		\$166,400
Stanislaus River	Valley View Dr.	Oakdale City Limits	I	1.69	Proposed		\$1,410,000
Valley Home Rd.	Gilbert Rd.	River Rd.	II	0.49	Proposed		\$13,800
Valley Home Rd.	River Rd.	E A St.	I	0.86	Proposed		\$717,100
Valley View Dr.	Stanislaus River	E C St.	I	0.38	Proposed		\$314,800
W G St.	Wood Ave.	S 6th Ave.	III	1.04	Proposed		\$13,100
W Greger St.	Crane Rd.	S Yosemite Ave.	II	2.48	Proposed		\$70,000
W J St.	Crane Rd.	Ash Ave.	II	1.11	Proposed		\$31,200

Segment Name	From	To	Bikeway Class	Length (Miles)	Status	Primary Segment	Cost
W J St.	Gilbert Ave.	S 1st Ave.	III	0.34	Proposed		\$4,200
W J St.	S Oak Ave.	Gilbert Ave.	II	0.50	Proposed		\$14,100
Willowood Dr.	Pontiac St.	E F St.	III	0.35	Proposed		\$4,400
Wood Ave.	W G St.	W J St.	III	0.17	Proposed		\$2,100
		Total Proposed		34.81			\$10,729,900



Figure 4-8: Oakdale Existing and Proposed Bikeway Network

4.11. City of Patterson

Planning and Policy Context

The following summarizes past planning efforts and establishes a policy framework to guide future transportation decisions and capital improvement programming. This undertaking is intended to promote regional planning, offer opportunities to coordinate infrastructure improvements, and to incorporate past planning efforts into the Current Plan.

General Plan (adopted 1992; revised 2004)

The Patterson General Plan includes reference to Non-Motorized travel in the Circulation Chapter. Several policies address safe convenient networks for bicycle and pedestrian travel, the inclusion of Class I and Class II bikeways where possible and require bicycle parking at new public facilities and commercial development.

Municipal Code

The Patterson Municipal Code includes provisions for bicycle parking for all land uses but single-family and two-family residential dwellings. The number of bicycle parking spaces required is based on the number of vehicle parking spaces, and ranges from 0 (if there are 1-4 vehicle parking spaces), to 10 (if there are 400 or more vehicle parking spaces).

Community Design Guidelines (2002)

The Community Design Guidelines include guidelines for commercial, industrial, and residential development. A goal of this document is to “Design for the pedestrian scale in appropriate areas.” This includes:

- Encourage pedestrian oriented buildings and site planning.
- Incorporate design elements that respond to environmental conditions such as wind, sun, shade, etc. to protect and shelter pedestrians and that will provide an enjoyable pedestrian experience.
- Encourage an appropriate scale of building height to street width in commercial areas. Prohibit or minimize parking between buildings and the street.

Existing Conditions

Located off of Highway 33 in the near center of the County, Patterson has a land area of nearly 3 square miles and is home to over 21,000 people. The City is known for its hub-and-spoke street pattern. Patterson has four miles of bikeways. The majority of facilities, over three miles, are Class II. West-East connections are located on Shearwater Drive, Salado Avenue, and Las Palmas Avenue. The only North-South connection is located on Ward Avenue.

Proposed Improvements

Proposed Class I facilities in Patterson include a path along State Route 33 between Sperry Avenue and the City of Newman, a path on Sperry Avenue between Ward Avenue and Baldwin Road, and a path connecting local parks and schools between Sperry Avenue and Ward Avenue.

Class II bike lanes are proposed on cross-town roads in Patterson including Ward Avenue between Sperry Avenue and State Route 33, 2nd Street between Ward Avenue and Barch Avenue, and American Eagle Avenue/M Street/Walnut Avenue between Sperry Avenue and Sycamore Avenue. Additional Class II Lanes are proposed on Shearwater Drive, Hartley Street, 1st Street, and Las Palmas Avenue.

No Class III bicycle routes are proposed in Patterson.

It is recommended that the City of Patterson update its bicycle plan.

Table 4-8 and **Figure 4-9** includes details for the Patterson bikeway network.

Table 4-8: Patterson Existing and Proposed Bikeway Facilities

Segment Name	From	To	Bikeway Class	Length (Miles)	Status	Primary Segment	Cost
E Las Palmas Ave.	S 1st St.	S Hartley St.	II	0.38	Existing		Existing
E St.	Sperry Ave.	1st St.	II	0.84	Existing		Existing
N Salado Ave.	Ward Ave.	N El Circulo.	II	0.51	Existing		Existing
Shearwater Dr.	Baldwin Rd.	James Burke Ave.	II	0.90	Existing		Existing
Sperry Ave.	S 9th St.	S Del Puerto Ave.	I	0.15	Existing		Existing
W Las Palmas Ave.	N 9th St.	S El Circulo.	II	0.33	Existing		Existing
W Las Palmas Ave.	Sperry Ave.	Ward Ave.	II	0.30	Existing		Existing
Ward Ave.	Sperry Ave.	Canal	I	0.59	Existing		Existing
		Total Existing		4.01			
American Eagle Ave.	Ward Ave.	Sweet Blair Dr.	II	1.53	Proposed		\$43,100
Class I	Ward Ave.	Sperry Ave.	I	1.37	Proposed		\$1,144,100
James Burke Ave.	Pipit Dr.	Ward Ave.	II	0.38	Proposed		\$10,700
M St.	Ward Ave.	N 1st St.	II	0.57	Proposed		\$16,000
N 1st St.	Olive Ave.	E Las Palmas Ave.	II	1.00	Proposed		\$28,100
N 9th St.	Ward Ave.	Sperry Ave.	III/II	0.68	Proposed		\$19,100
N Hartley St.	Walnut Ave.	Chesterfield Dr.	II	0.72	Proposed		\$20,400
Peregrine Dr.	Flicker Ln.	Heartland Ranch Ave.	II	0.41	Proposed		\$11,500
Pipit Dr.	American Eagle Ave.	W Las Palmas Ave.	II	0.32	Proposed		\$8,900
S 1st St.	E Las Palmas Ave.	Patterson City Limits	II	0.66	Proposed		\$18,700
S Del Puerto Ave.	S El Circulo.	Poppy Ave.	III/II	0.64	Proposed		\$18,000
S El Circulo.	All	All	II	0.54	Proposed		\$15,200
Sperry Ave.	Baldwin Rd.	S American Eagle Ave.	I	1.02	Proposed		\$847,500
Sperry Ave.	Baldwin Rd.	WSID Lateral No 6	II	0.23	Proposed		\$6,600
Sperry Ave.	S 9th St.	S Del Puerto Ave.	II	0.15	Proposed		\$4,300
Sperry Ave.	S Del Puerto Ave.	S 2nd St.	III/II	0.47	Proposed		\$13,300
Sperry Ave.	Ward Ave.	S 9th St.	II	0.35	Proposed		\$10,000
SR 33	Ward Ave.	Bartch Ave.	II	2.54	Proposed		\$71,500
W Las Palmas Ave.	N El Circulo	S 2nd St.	II	0.20	Proposed		\$5,500
W Las Palmas Ave.	S 2nd St.	S 1st St.	II	0.09	Proposed		\$2,600
W Las Palmas Ave.	Ward Ave.	S 9th St.	II	0.23	Proposed		\$6,400
Walnut Ave.	N 1st St.	Sycamore Ave.	II	0.95	Proposed		\$26,800
Ward Ave.	SR 33	Sperry Ave.	II	1.69	Proposed		\$47,500
		Total Proposed		16.72			\$2,395,800

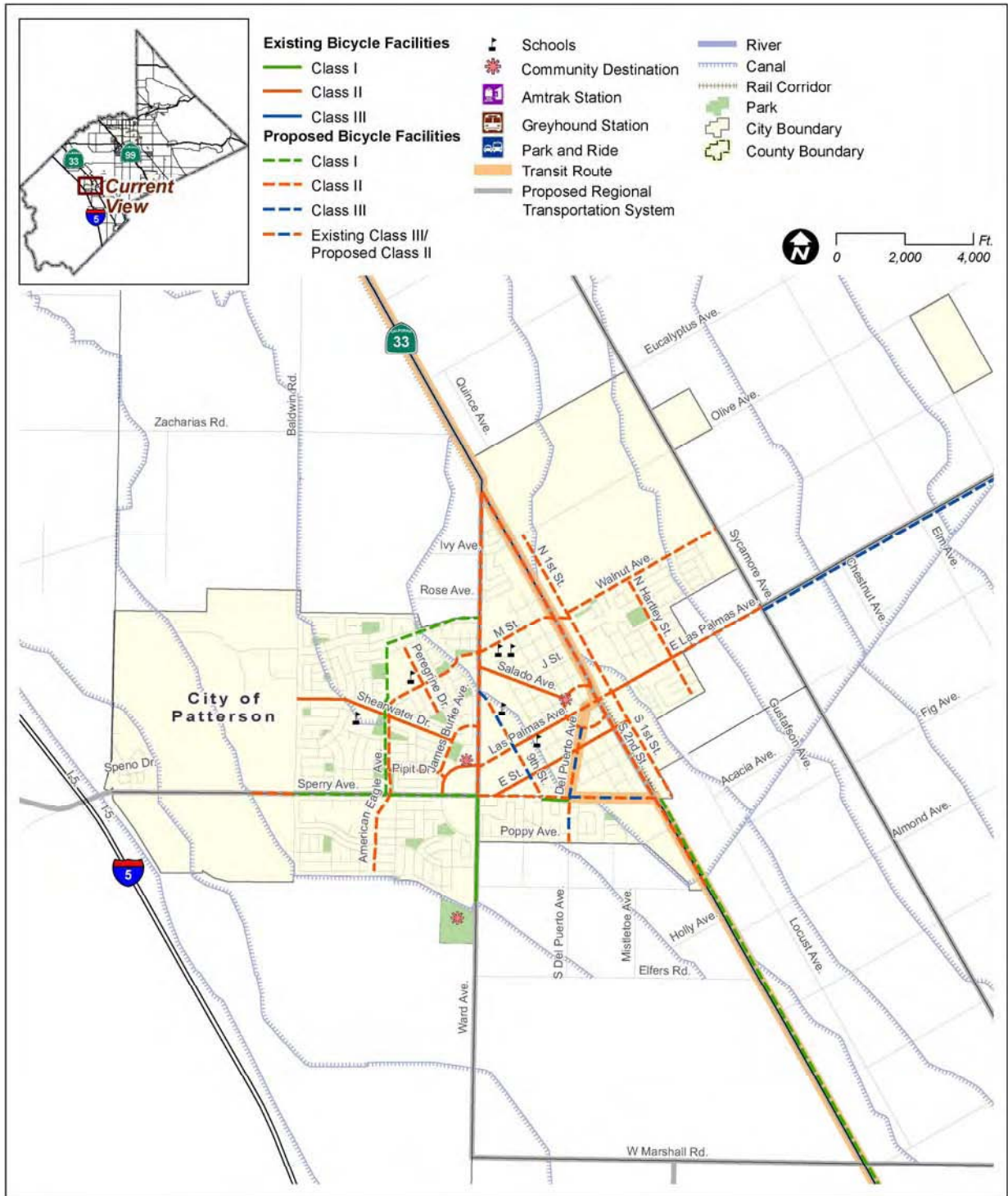

Figure 4-9: Patterson Existing and Proposed Bikeway Network

4.12. City of Riverbank

Planning and Policy Context

The following summarizes past planning efforts and establishes a policy framework to guide future transportation decisions and capital improvement programming. This undertaking is intended to promote regional planning, offer opportunities to coordinate infrastructure improvements, and to incorporate past planning efforts into the Current Plan.

General Plan (2007, Draft)

Riverbank is currently updating its General Plan. The draft Circulation Element includes goals and policies supportive of Non-Motorized transportation. One goal is to ensure convenience and choice for all modes of transportation. Policies supportive of Non-Motorized transportation include the provision of bicycle and pedestrian facilities and network connections in new growth areas and in existing areas where possible.

The existing Riverbank General Plan includes standard sections for bike lanes and paths as well as arterial and collector roads with 5-foot sidewalks and 5-foot bike lanes. The Plan also includes figures with descriptions of Class II and III bikeways.

Existing Conditions

Located on the northern border of the County along the Stanislaus River and intersected by Highway 108, Riverbank comprises an area of over three square miles and is home to 15,000 people. The City is bisected by a rail line creating a barrier between the western and eastern portions of the City. Riverbank has over three miles of Class II bikeways. The West-East connections are located on Patterson Road, Morrill Road, and Atchison Street.

Proposed Improvements

Proposed Class I facilities in Riverbank include a north-south path along the railroad corridor adjacent to Terminal Avenue, connecting to Modesto, and an east-west path along Claribel Road to Modesto.

Class II bike lanes are proposed on cross-town routes in Riverbank including Crawford Road, Morrill Road, Kentucky Avenue, Oakdale Road (connecting to Modesto), Roselle Avenue (connecting to Modesto), Terminal Avenue, and Claus Road.

Class III bicycle routes are proposed in Riverbank on Sierra Street, 1st Street, Jackson Avenue and Oakdale Road.

Table 4-9 and **Figure 4-10** include details for the Riverbank bikeway network.

Table 4-9: Riverbank Existing and Proposed Bikeway Network

Segment Name	From	To	Bikeway Class	Length (Miles)	Status	Primary Segment	Cost
Atchinson St.	1st St.	7th St.	II	0.55	Existing		Existing
Claribel Rd.	Terminal Ave.	Claus Rd.	II	0.41	Existing		Existing
Morrill Rd.	Oakdale Rd.	Roselle Ave.	II	1.00	Existing		Existing
Patterson Rd.	1st St.	Claus Rd.	II	0.87	Existing		Existing
Squire Wells Wy.	Morrill Rd.	Novi Dr.	II	0.23	Existing		Existing
		Total Existing		3.05			
1st St.	North of City Limits	Patterson Rd.	III	0.75	Proposed		\$9,400
8th St.	Santa Fe St.	Sierra St.	III	0.14	Proposed		\$1,700
Candlewood Pl.	Oakdale Rd.	Estelle Ave.	III	0.24	Proposed		\$3,100

Segment Name	From	To	Bikeway Class	Length (Miles)	Status	Primary Segment	Cost
Claribel Rd.	Oakdale Rd.	Claus Rd.	I	2.02	Proposed		\$1,679,600
Class I Connector	Claus Rd.	Riverbank City Limits	I	0.50	Proposed		\$417,100
Claus Rd.	SR 108	Claribel Rd.	II	1.80	Proposed		\$50,800
Estelle Ave.	Candlewood Pl.	Stanislaus St.	III	0.06	Proposed		\$800
Hi Tech Parkway.	S Yosemite Ave.	Post Rd.	II	0.44	Proposed		\$12,300
Jackson Ave.	Stanislaus St.	Morrill Rd.	III	0.69	Proposed		\$8,600
Kentucky Ave.	Terminal Ave.	Eleanor Ave.	II	1.27	Proposed		\$35,900
MID Main	Oakdale Rd.	Roselle Ave.	I	1.36	Proposed		\$1,137,000
MID Main	Roselle Ave.	Riverbank City Limits	I	0.68	Proposed		\$569,500
Oakdale Rd.	Claribel Rd.	Crawford Rd.	II	0.50	Proposed	18	\$14,000
Oakdale Rd.	Park Ridge Dr.	Patterson Rd.	III	0.49	Proposed		\$6,200
Oakdale Rd.	Patterson Rd.	Claribel Rd.	II	1.00	Proposed		\$28,200
Parallel to Crawford Rd.	Carver Rd.	MID Main	I	5.30	Proposed		\$4,417,200
Patterson Rd.	Roselle Ave.	1st St.	III	0.13	Proposed		\$1,700
Roselle Ave.	Patterson Rd.	Claribel Rd.	II	1.50	Proposed		\$42,400
Santa Fe St.	8th St.	Eleanor Ave.	II	1.03	Proposed		\$29,000
Sierra St.	1st St.	Claus Rd.	III	0.90	Proposed		\$11,400
Sierra St.	Jackson Ave.	Patterson Rd.	III	0.58	Proposed		\$7,300
Stanislaus St.	Estelle Ave.	Jackson Ave.	III	0.25	Proposed		\$3,100
Terminal Ave.	Patterson Rd.	Claribel Rd.	II	1.51	Proposed		\$42,700
		Total Proposed		23.15			\$8,529,000

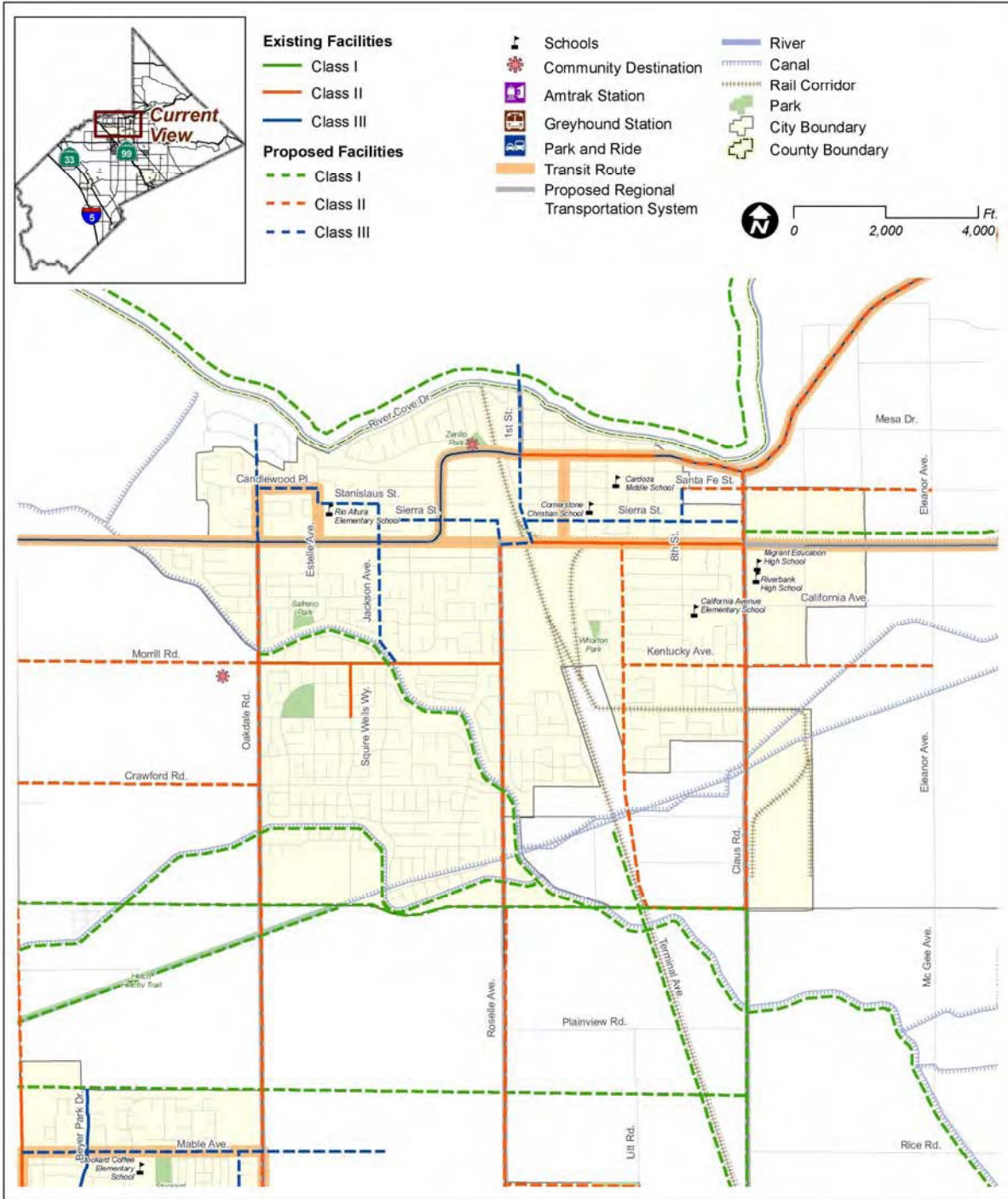

STANCOG NMTMP - RIVERBANK

Figure 4-10: Riverbank Existing and Proposed Bikeway Network

4.13. City of Turlock

Planning and Policy Context

The following summarizes past planning efforts and establishes a policy framework to guide future transportation decisions and capital improvement programming. This undertaking is intended to promote regional planning, offer opportunities to coordinate infrastructure improvements, and to incorporate past planning efforts into the Current Plan.

General Plan (2002)

Turlock's Transportation Element of the General Plan includes a chapter addressing pedestrian and bicycle circulation. The plan includes principles and policies to promote bicycling and walking as a means of transportation and as recreation. Specific policies include the provision for access to parks and recreational facilities and bicycle parking at principle end trip facilities such as employment centers, downtown, and high density multifamily residential projects. The Plan includes a Bikeways and Trails Map and states that the City has adopted a Master Bikeway Plan.

Municipal Code

The Turlock Municipal Code includes provisions for bicycle parking for many types of development including commercial, industrial and civic uses. Where ten or more automobile parking spaces are required, bicycle parking is to be provided at a rate of 10% of automobile parking. The Code also specifies design standards for bicycle parking.

Design Guidelines

Turlock's Design Guidelines include discussion of pedestrian access from and through parking lots, pedestrian amenities including benches and fountains, and site design to reduce pedestrian-vehicle conflicts.

Downtown Design Guidelines (2003)

The Design Guidelines for Downtown Turlock include streetscape amenities that benefit pedestrians, such as benches, trash cans, and way-finding signage, as well as guidelines for locating bicycle parking near transit stops and office buildings to encourage bicycling as an alternative to automobile use.

Existing Conditions

Located near the southern border of the County and intersected by Highways 99 and 165, Turlock is the second largest City in the County. It comprises an area of over 13 square miles and is home to over 55,000 people. Turlock is bisected by Highway 99 and the rail line. The City has 32 miles of bikeways. Over 21 miles are Class II facilities and there are 10 miles of Class I facilities. West-East connections are located on West Monte Vista Avenue, East Hawkeye Avenue, and West Taylor Road. North-South connections are located on North Berkeley Avenue and Walnut Road.

Proposed Improvements

Proposed Class I facilities in Turlock include an east-west path along Taylor Road between North Golden State Boulevard and North Waring Road; a path along North Golden State Boulevard between West Taylor Road and the County line; an east-west path along East Canal Drive between North Front Street and North Verduga Road; an east-west path along High Street between the City limit and Downtown; and an east-west path along Harding Road between South Washington Road and the County line.

Class II bike lanes are proposed on many of Turlock's major cross-town roads, including Tenger Road (except for a gap between Fulkerth Road and Canal Drive), Johnson Road, Waring Road, Springer Drive, Tuolumne Road,

Fulkerth Road/Hawkeye Avenue, and Linwood Avenue. Several Class III bicycle routes are proposed throughout the City of Turlock including Minnesota Avenue, Palm Street, South Avenue, South Orange Street, 5th Street, West Canal Drive, East Avenue, South Avenue and Quincy Road.

Table 4-10 and **Figure 4-11** include details for the Turlock bikeway network.

Table 4-10: Turlock Existing and Proposed Bikeway Network

Segment Name	From	To	Bikeway Class	Length (Miles)	Status	Primary Segment	Cost
Along Turlock City Limits	E Taylor Rd.	E Monte Vista Ave.	I	1.03	Existing		Existing
Atherstone Rd.	N Golden State Blv.	N Tegner Rd.	I	0.18	Existing		Existing
Class I	W Taylor Rd.	Paseo Entrada Connector	I	0.20	Existing		Existing
Class I	W Taylor Rd.	Paseo Del Sol Connector	I	0.21	Existing		Existing
Class I Along Canal	N Front St.	N Daubenberger Rd.	I	2.01	Existing		Existing
Class I Connector	Paseo Entrada Connector	Paseo Del Sol Connector	I	0.25	Existing		Existing
Class II	Class I	W Christoffersen Pkwy.	II	0.34	Existing		Existing
Colorado Ave.	E Hawkeye Ave.	E Canal Dr.	II	0.52	Existing		Existing
Countryside Dr.	W Monte Vista Ave.	Shetland Wy.	II	0.83	Existing		Existing
Crowell Rd.	W Monte Vista Ave.	W Tuolumne Rd.	II	0.50	Existing		Existing
Dels Ln.	W Monte Vista Ave.	W Hawkeye Ave.	II	1.00	Existing		Existing
E Hawkeye Ave.	Hwy 99	N Verduga Rd.	II	3.83	Existing		Existing
E Monte Vista Ave.	N Berkeley Ave.	City Boundary	II	0.26	Existing		Existing
E Springer Dr.	Geer Rd.	Berkeley Ave.	II	1.05	Existing		Existing
E Tuolumne Rd.	Geer Rd.	N Waring Rd.	II	2.02	Existing		Existing
Georgetown Ave.	N Walnut Rd.	Dels Ln.	II	0.50	Existing		Existing
Melones Dr.	All	All	I	0.73	Existing		Existing
N Berkeley Ave.	E Taylor Rd.	W Canal Dr.	II	2.51	Existing		Existing
N Daubenberger Rd.	E Hawkeye Ave.	East Ave.	III	1.00	Existing		Existing
N Olive Ave.	E Springer Dr.	E Zeering Rd.	II	0.18	Existing		Existing
N Soderquist Rd.	Fulkerth Rd.	W Canal Dr.	II	0.48	Existing		Existing
N Tully Rd.	W Tuolumne Rd.	West Main St.	II	1.60	Existing		Existing
N Walnut Rd.	W Taylor Rd.	W Tuolumne Rd.	II	1.52	Existing		Existing
Paseo Del Sol	N Kilroy Rd.	Panorama Ave.	I	0.26	Existing		Existing
Paseo Entrada	N Tegner Rd.	Class I Connector	I	0.27	Existing		Existing
S Walnut Rd.	Class II Connector	W Linwood Ave.	II	0.68	Existing		Existing
Shetland Wy.	Countryside Dr.	N Tully Rd.	II	0.26	Existing		Existing
W Christoffersen Pkwy.	N Golden State Blv.	N Walnut Rd.	I	1.03	Existing		Existing
W Monte Vista Ave.	N Tegner Rd.	Greer Rd.	II	2.18	Existing		Existing
W Springer Dr.	Magnolia Dr.	Sandy Wy.	II	0.36	Existing		Existing
W Springer Dr.	Memory Ln.	Geer Rd.	II	0.29	Existing		Existing
W Springer Dr.	Panorama Ave.	Magnolia Dr.	I	0.63	Existing		Existing
W Taylor Rd.	N Tenger Rd.	Turlock City Limits	I	3.26	Existing		Existing
W Tuolumne Rd.	Countryside Dr.	Dels Ln.	II	1.05	Existing		Existing
		Total Existing		33.03			
5th St.	Lander Ave.	E Linwood Ave.	III	1.09	Proposed		\$13,700
Annhurst Ave.	E Minnesota Ave.	Baylor Ave.	III	0.31	Proposed		\$4,000

Segment Name	From	To	Bikeway Class	Length (Miles)	Status	Primary Segment	Cost
Baylor Ave.	Loyola Wy.	Annhurst Ave.	III	0.06	Proposed		\$700
Cahill Ave./Zinfandel Ln.	Minaret Ave.	N Daubenberger Rd.	III	1.46	Proposed		\$18,400
Chestnut St.	N Soderquist Rd.	N Front St.	III	0.53	Proposed		\$6,700
Class I Connector	North Ave.	E Hawkeye Ave.	I	0.19	Proposed		\$159,300
Class I Connector	Turlock City Limits	N Golden State Blv.	I	0.39	Proposed		\$328,900
Class II Connector	Crowell Rd.	W Taylor Rd.	I	0.08	Proposed		\$67,200
Class II Connector	N Kilroy Rd.	Black Oak St.	I	0.09	Proposed		\$71,700
Class II Connector	N Quincy Rd.	N Waring Rd.	II	0.51	Proposed		\$14,400
Class II Connector	N Walnut Rd.	Paseo Belleza	I	0.05	Proposed		\$39,800
Class II Connector	Panorama Ave.	N Walnut Rd.	I	0.25	Proposed		\$210,300
Class II Connector	S Walnut Rd.	S Tully Rd.	II	0.08	Proposed		\$2,200
Colorado Ave.	E Taylor Rd.	E Tuolumne Rd.	III	1.51	Proposed		\$19,100
Columbia St.	S Soderquist Rd.	S Orange St.	III	0.55	Proposed		\$6,900
Crane Ave.	S Golden State Blv.	S Palm St.	III	0.21	Proposed		\$2,600
Crowell Rd.	Paseo Belleza	Class II Connector	I	0.11	Proposed		\$93,900
Dianne Dr.	Fulkerth Rd.	Polous Dr.	II	0.12	Proposed		\$3,300
Dianne Dr.	North of W Canal Dr.	West Main St.	II	0.67	Proposed		\$18,800
E Hawkeye Ave.	N Tegner Rd.	Hwy 99	II	0.43	Proposed		\$12,100
E Monte Vista Ave.	City Boundary	N Waring Rd.	I	0.77	Proposed		\$641,100
E Springer Dr.	Berkeley Ave.	Country Walk Ln.	II	0.20	Proposed		\$5,700
East Ave.	N Berkeley Ave.	S Verduga Rd.	III	1.26	Proposed		\$15,900
Ferreira Ranch Dr.	W Taylor Rd.	W Christoffersen Pkwy.	II	0.60	Proposed		\$17,000
Flower St.	N Orange St.	N 1st St.	III	0.17	Proposed		\$2,200
Fosberg Rd.	E Taylor Rd.	E Monte Vista Ave.	III	1.00	Proposed		\$12,600
Geer Rd.	W Taylor Rd.	Turlock City Limits	II	0.02	Proposed		\$600
Geer Rd.	W Taylor Rd.	Turlock City Limits	III	0.02	Proposed		\$300
Hartwick Ave.	N Olive Ave.	Colorado Ave.	III	0.26	Proposed		\$3,300
High St. Extension	S Washington Rd.	S Broadway Ave.	I	3.15	Proposed		\$2,628,500
Hillsdale Dr.	Fosberg Rd.	N Olive Ave.	III	0.25	Proposed		\$3,100
Lambert Wy.	W Canal Dr.	N Soderquist Rd.	III	0.20	Proposed		\$2,500
Lander Ave.	SR 99 NB Off-Ramp	Simmons Rd.	I	0.26	Proposed		\$216,300
Loyola Wy.	Baylor Ave.	North Ave.	III	0.12	Proposed		\$1,500
Minaret Ave.	E Main St.	East Ave.	III	0.44	Proposed		\$5,500
Mountain View Rd.	W Christoffersen Pkwy.	Roberts Rd.	II	0.24	Proposed		\$6,700
Myrtle St.	Minaret Ave.	N Berkeley Ave.	III	0.50	Proposed		\$6,300
N Golden State Blv.	W Taylor Rd.	Turlock City Limits	I	4.58	Proposed		\$3,820,000
N Golden State Blv.	W Taylor Rd.	Turlock City Limits	III	0.02	Proposed		\$300
N Johnson Rd.	E Tuolumne Rd.	E Hawkeye Ave.	II	0.50	Proposed		\$14,100
N Kilroy Rd.	W Taylor Rd.	Roberts Rd.	II	0.57	Proposed		\$15,900
N Olive Ave.	E Christoffersen Pkwy.	Hartwick Ave.	III	0.31	Proposed		\$3,900
N Olive Ave.	E Taylor Rd.	E Springer Dr.	III	0.31	Proposed		\$4,000
N Palm St.	E Hawkeye Ave.	Monroe Ave.	III	0.53	Proposed		\$6,700
N Palm St.	Monroe Ave.	Minaret Ave.	III	0.58	Proposed		\$7,400
N Quincy Rd.	E Tuolumne Rd.	East Ave.	III	1.50	Proposed		\$18,900
N Quincy Rd.	Turlock City Limits	E Tuolumne Rd.	II	0.25	Proposed		\$7,100

Segment Name	From	To	Bikeway Class	Length (Miles)	Status	Primary Segment	Cost
N Soderquist Rd.	W Canal Dr.	West Main St.	II	0.52	Proposed		\$14,700
N Tegner Rd.	W Monte Vista Ave.	Fulkerth Rd.	II	1.08	Proposed		\$30,400
N Tegner Rd.	W Taylor Rd.	Atherstone Rd.	I	0.27	Proposed		\$229,100
N Waring Rd.	Turlock City Limits	Class II Connector	II	0.50	Proposed		\$14,200
North Ave.	Loyola Wy.	North Highlands Ave.	III	0.25	Proposed		\$3,100
North Highlands Ave.	North Ave.	E Hawkeye Ave.	III	0.19	Proposed		\$2,400
Parallel to SR 99	Lander Ave.	Golf Rd.	I	1.14	Proposed		\$951,900
Paseo Belleza	Class II Connector	Crowell Rd.	I	0.25	Proposed		\$210,800
Paseo De Leon	Black Oak St.	Panorama Ave.	I	0.22	Proposed		\$186,300
Roberts Rd.	N Golden State Blv.	N Kilroy Rd.	III	0.31	Proposed		\$3,900
S Berkeley Ave.	Larkspur Pl.	Brier Rd.	II	0.34	Proposed		\$9,500
S Minaret Ave.	East Ave.	S Berkeley Ave.	III	0.78	Proposed		\$9,800
S Orange St.	Flower St.	Montana Ave.	III	1.08	Proposed		\$13,600
S Soderquist Rd.	West Main St.	West Main St.	III	0.06	Proposed		\$800
S Tegner Rd.	Turlock City Limits	W Linwood Ave.	II	1.52	Proposed		\$43,000
S Tully Rd.	Class I Connector	Class II Connector	II	0.12	Proposed		\$3,400
South Ave.	S Tully Rd.	S Orange St.	III	0.93	Proposed		\$11,800
W Canal Dr.	N Walnut Rd.	Lambert Wy.	III	0.62	Proposed		\$7,800
W Canal Dr.	N Washington Rd.	N Walnut Rd.	II	1.49	Proposed		\$42,000
W Linwood Ave.	S Tegner Rd.	Golf Rd.	II	3.01	Proposed		\$84,900
W Minnesota Ave.	Crowell Rd.	Colorado Ave.	III	1.50	Proposed		\$18,900
W Taylor Rd.	N Golden State Blv.	N Tenger Rd.	I	0.26	Proposed		\$217,000
W Tuolumne Rd.	N Tegner Rd.	N Golden State Blv.	II	0.45	Proposed		\$12,800
		Total Proposed		44.22			\$10,683,500

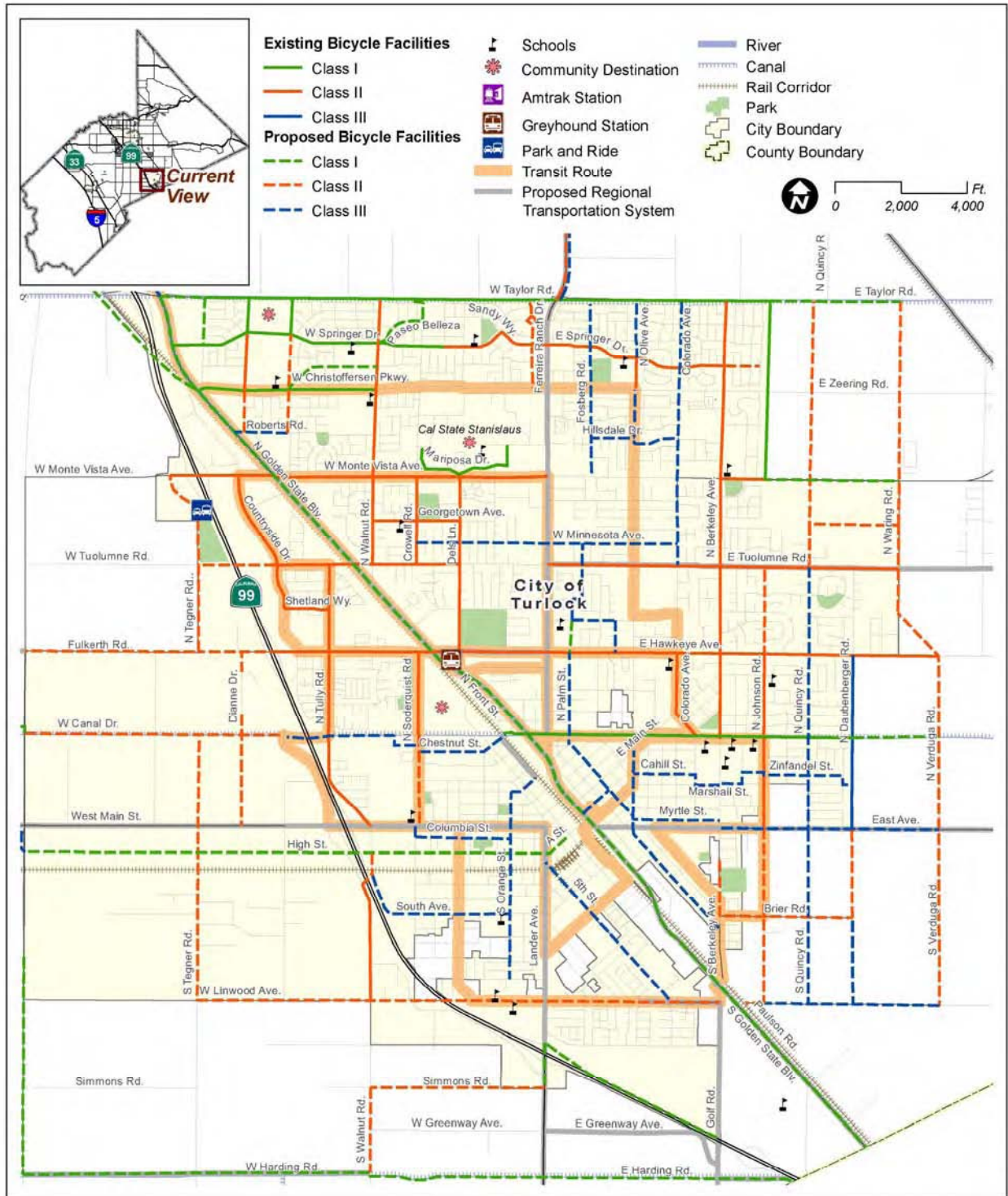

Figure 4-11: Turlock Existing and Proposed Bikeway Network

4.14. City of Waterford

Planning and Policy Context

The following summarizes past planning efforts and establishes a policy framework to guide future transportation decisions and capital improvement programming. This undertaking is intended to promote regional planning, offer opportunities to coordinate infrastructure improvements, and to incorporate past planning efforts into the Current Plan.

General Plan (2006, Draft)

The Waterford General Plan includes a number of goals and policies to improve Non-Motorized transportation. The Plan includes goals to reduce vehicle miles traveled (VMT) and to develop land use patterns that encourage biking and walking. Policies encouraging the use of bicycles, providing bicycle facilities, expanding the bicycle circulation system promote bicycle use in the city. The Waterford General Plan also has policies encouraging pedestrian friendly environments and improving pedestrian planning.

According to the General Plan, the City of Waterford adopted a Bicycle Master Plan in 2000. The Plan is described to have standards for bicycle route improvements, designates routes, and provides connections to the regional bicycle route system.

The Plan calls the City to work with local and regional governments and agencies to develop a regional bicycle network strategy. The strategy should include provisions for bikeway connections to Waterford's river park trail system and other City recreational areas.

Existing Conditions

Located along Highway 132 and intersected by a rail line, Waterford comprises over 1.5 square miles and is home to nearly 7,000 people. The Tuolumne River runs along the City's southern border. Waterford has over 7 miles of bikeways. The majority of mileage is a Class I facility running along the northern edge of the City on the Modesto Irrigation District Canal. Other connections include the Pecan Avenue-Dorsey Street West-East connection and the F Street North-West connection.

Proposed Improvements

A system of Class I facilities would connect Waterford Middle School and the canal at the eastern edge of town, following Eucalyptus Avenue and Bonnie Brae Avenue. Another path would follow the Tuolumne River along the south city limit.

Class II bike lanes are proposed on major arterials through Waterford including State Route 132 and the Oakdale-Waterford Highway. Bike lanes are also proposed along the west side of town on North Reinway Avenue.

Class III bicycle routes are proposed in Waterford on roads through the city including Riverside Road, Bentley Street, Pecan Avenue, Tim Bell Road and Washington Road.

Table 4-11 and **Figure 4-12** include details for the Waterford bikeway network.

Table 4-11: Waterford Existing and Proposed Bikeway Network

Segment Name	From	To	Bikeway Class	Length (Miles)	Status	Primary Segment	Cost
Bentley St.	D St.	Tim Bell Rd.	II	0.25	Existing		Existing
Bentley St.	F St.	D St.	III	0.15	Existing		Existing
Bentley St.	G St.	I St.	II	0.15	Existing		Existing
Bentley St.	G St.	F St.	III	0.08	Existing		Existing
Bentley St.	I St.	Yosemite Blv.	III	0.02	Existing		Existing
Bentley St.	Tim Bell Rd.	Skyline Blv.	III	0.70	Existing		Existing
Bonnie Brae Ave.	F St.	Canal	III	0.63	Existing		Existing
C St.	Bonnie Brae Ave.	Bentley St.	III	0.36	Existing		Existing
Class I Connector	Tim Bell Rd.	Bentley St.	I	0.55	Existing		Existing
Class I Connector	Waterford City Limits	Bonnie Brae Ave.	I	0.16	Existing		Existing
D St.	Bentley St.	Welch St.	III	0.09	Existing		Existing
Dorsey St.	Church St.	F St.	III	0.19	Existing		Existing
Dorsey St.	F St.	C St.	III	0.22	Existing		Existing
F St.	Waterford City Limits	Yosemite Blv.	II	0.90	Existing		Existing
G St.	Bentley St.	Yosemite Blv.	III	0.13	Existing		Existing
Hickman St.	Tim Bell Rd.	N Appling Rd.	III	0.07	Existing		Existing
Kadota Ave.	N Reinway Ave.	Church St.	III	0.43	Existing		Existing
N Appling Rd.	Yosemite Blv.	Tuolomne River	III	0.18	Existing		Existing
N Reinway Ave.	Yosemite Blv.	MID Canal	II	0.52	Existing		Existing
Pecan Ave.	N Reinway Ave.	Church St.	III	0.43	Existing		Existing
Riverside Rd.	S Western Ave.	Yosemite Blv.	III	0.48	Existing		Existing
Rose Wy.	Church St.	F St.	III	0.08	Existing		Existing
S Reinway Ave.	Washington Rd.	End of S Reinway Ave.	III	0.34	Existing		Existing
S Reinway Ave.	Yosemite Blv.	Washington Rd.	III	0.19	Existing		Existing
S Western Ave.	Washington Rd.	Riverside Rd.	III	0.11	Existing		Existing
S Western Ave.	Yosemite Blv.	Washington Rd.	III	0.18	Existing		Existing
Skyline Blv.	Bentley St.	Yosemite Blv.	III	0.32	Existing		Existing
Stein Wy.	Kadota Ave.	Washburn Ave.	I	0.09	Existing		Existing
Tim Bell Rd.	Bonnie Brae Ave.	Welch St.	III	0.34	Existing		Existing
Tim Bell Rd.	Waterford City Limits	Bonnie Brae Ave.	III	0.15	Existing		Existing
Tim Bell Rd.	Welch St.	Hickman St.	III	0.24	Existing		Existing
Washington Rd.	S Reinway Ave.	S Western Ave.	III	0.37	Existing		Existing
Welch St.	D St.	Tim Bell Rd.	II	0.17	Existing		Existing
Welch St.	F St.	D St.	III	0.15	Existing		Existing
Yosemite Blv.	S Eucalyptus Ave.	S Reinway Ave.	II	0.26	Existing		Existing
		Total Existing		9.70			
MID Canal	Western City Limits	Eastrn City Limit	I	2.29	Proposed		\$1,906,900
N Western Ave.	Washburn Ave.	F St.	I	0.06	Proposed		\$46,000
Tuolomne River	Waterford City Limits	Waterford City Limits	I	1.80	Proposed		\$1,501,200
Washburn Ave.	Stein Wy.	N Western Ave.	I	0.25	Proposed		\$205,600
WID Canal	N Reinway Ave.	Kadota Ave.	I	0.20	Proposed		\$165,300
WID Lateral	Tim Bell Rd.	MID Canal	I	0.57	Proposed		\$478,100
Yosemite	City Limits	County Limits	III	1.01	Proposed		\$12,700

Segment Name	From	To	Bikeway Class	Length (Miles)	Status	Primary Segment	Cost
Yosemite Blv.	Baker St.	N Appling Rd.	II	0.07	Proposed		\$2,000
Yosemite Blv.	Center St.	Riverside Rd.	II	0.14	Proposed		\$4,100
Yosemite Blv.	Hickman Rd.	S E St.	II	0.08	Proposed		\$2,300
Yosemite Blv.	N Appling Rd.	City Limits	II	0.94	Proposed		\$26,600
Yosemite Blv.	Riverside Rd.	Hickman Rd.	II	0.11	Proposed		\$3,000
Yosemite Blv.	S E St.	Baker St.	II	0.14	Proposed		\$4,000
Yosemite Blv.	S Reinway Ave.	S Western Ave.	II	0.37	Proposed		\$10,400
Yosemite Blv.	S Western Ave.	Center St.	II	0.16	Proposed		\$4,600
		Total Proposed		8.19			\$4,372,800

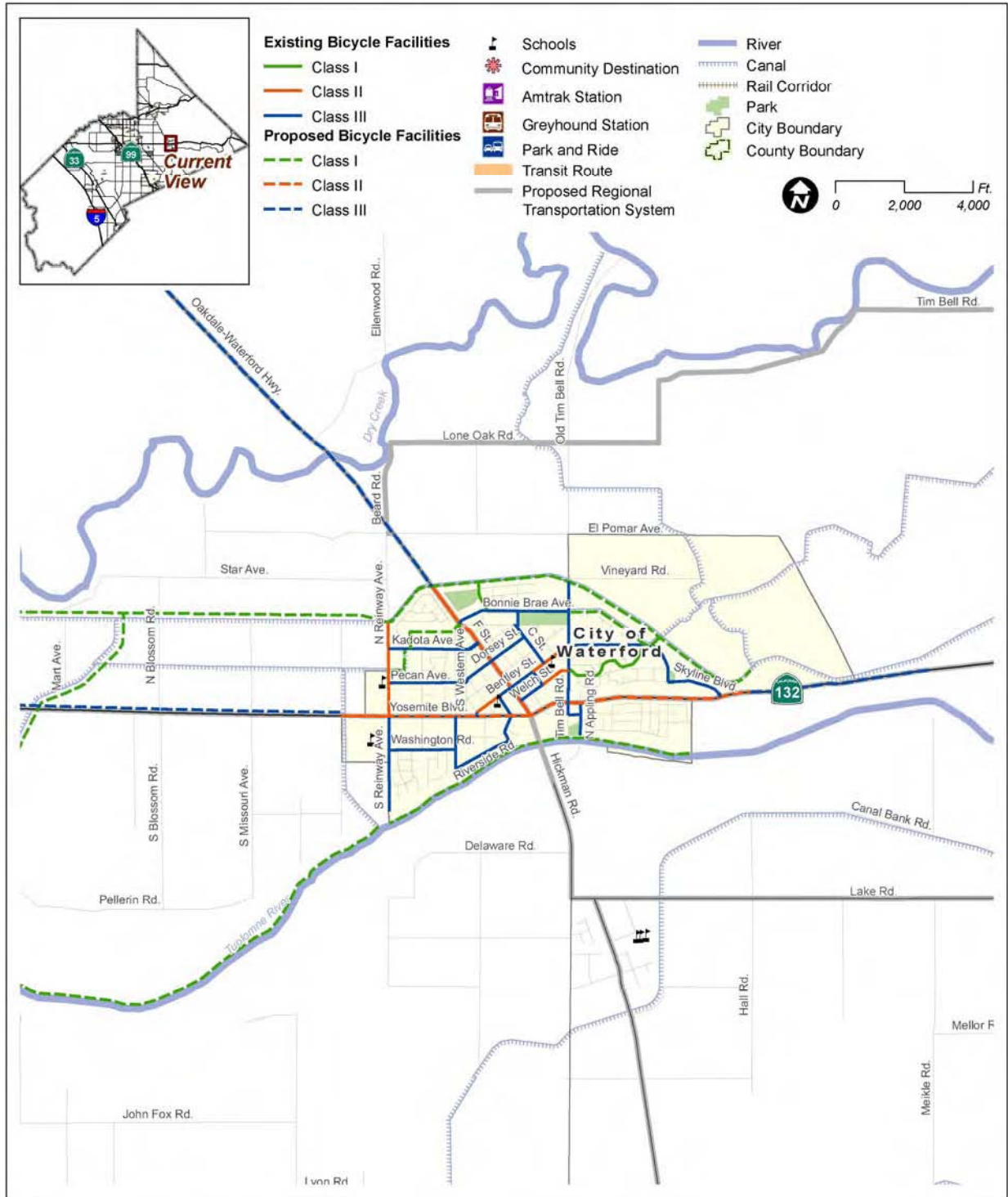

Figure 4-12: Waterford Existing and Proposed Bikeway Network

This page intentionally left blank

5. Recommended Pedestrian Facilities

5.1. Introduction

The following section details projects that provide increased opportunities for residents of Stanislaus County to walk for transportation or recreation.

Improvements were selected by:

- Input from staff from Stanislaus County and CCOG
- Input from the Steering Committee
- Previous priority projects (from existing planning efforts)
- Local knowledge and experience of the consultant team, the orientation of funding programs, and the planning criteria outlined below

Most pedestrian activity in Stanislaus County occurs in the developed areas of the county . As a result most of the County's existing sidewalks are located in those areas. In addition to these areas this analysis also considers rural roads.

5.2. Definition of Pedestrian Facilities

Generally, there are two types of pedestrian facilities, those intended for exclusive use by pedestrians, such as sidewalks, and those shared with other users (i.e. Class I Multi-use Pathways). In addition, in California sidewalks can be legally used by cyclists unless otherwise signed or locally regulated. Pedestrian facilities at intersections can include crosswalks, pedestrian crosswalk signals, warning signage, curb ramps and other treatments to promote safety and accessibility for disabled users.

The California Vehicle Code Section 275 defines a crosswalk as either:

- That portion of a roadway included within the prolongation or connection of the boundary lines of sidewalks at intersections where the intersecting roadways meet at approximately right angles, except the prolongation of such lines from an alley across a street.
- Any portion of a roadway distinctly indicated for pedestrian crossing by lines or other markings on the surface.

At intersections, a crosswalk is effectively a legal extension of the sidewalk across the roadway. Crosswalks are present at all intersections, whether marked or unmarked, unless the pedestrian crossing is specifically prohibited by the local jurisdiction. At mid-block locations, crosswalks only exist if they are marked.

Traffic control devices must follow the procedures set forth in the California version of the Manual of Uniform Traffic Control Devices (CAMUTCD), while elements such as sidewalks and curb cuts must comply with guidelines for implementing the federal Americans with Disabilities Act (ADA).

5.3. Existing Conditions

Nonexistent or Inadequate Facilities

There are numerous places where sidewalks do not exist or end abruptly. The majority of the County's sidewalks are in the developed areas of the county where pedestrian activity is higher. Most rural roads do not have sidewalks. Although some of these roads have paved shoulders which are used for walking, such shoulders are not designed for pedestrian safety. See the preceding collision analysis for information on collisions that occurred while pedestrians were walking along the edge or shoulder of the road.

Accessibility

Although there are several locations where wheelchair ramps exist, there are many places where they do not exist, or where, if they do exist, they are in conjunction with discontinuous sidewalks. In addition, paved shoulders alongside rural roads used for walking do not meet ADA requirements. See the following section on Transit Access for more details.

Connectivity

Among the problems created by nonexistent sidewalks or those that are discontinuous is that pedestrians cannot rely on paths to connect them to places to which they desire to walk. This issue exists on both small and large scales in Stanislaus County. There are in areas in the commercial and employment areas of the developed county where crossings of state highways are lacking between nearby destinations such as schools and employment centers. In addition, most rural roads do not have sidewalks or adjacent pathways or trails for walking. This contributes to a countywide problem of connectivity between neighboring communities or between neighborhoods and destinations such as local schools or markets.

Safety

As described in Section 3: Needs Analysis, there have been an average of 172 injuries in the preceding five years. Provision of sidewalks in these areas would increase safety, as would improved crossings at locations where pedestrians were hit either in or outside the crosswalk. Improved crossings could include upgrading existing crosswalks or installing new crosswalks.

Access to Transit

Pedestrian access to transit is a key component of a successful local pedestrian network and enables walking as a regional mode of transportation. Typical access to transit improvements includes:

- Bus stop signs
- Information kiosks
- Shelters
- Sidewalks or pathways to access the transit stop within a 0.5 to 0.75 radius
- Benches
- Accessibility for disabled users in the form of paved bus stop areas and curb ramps that meet Americans with Disabilities (ADA) Act design requirements.

As described in the previous section under bicycle to transit access, Stanislaus Regional Transit (StaRT) operates fixed-route service through the County while BLAST, CAT, MAX, and ROTA provide local service. Currently all transit stops are marked with signs. Though StaRT stops are ADA compliant, not all stops are or have sidewalks or pathways for pedestrian access. No specific policies are in place to ensure sidewalks or pathways within the catchment zone of the bus stop.

5.4. Proposed Countywide Pedestrian Facility Improvements

This section discusses capital project recommendations for the Stanislaus County pedestrian network. These infrastructure improvements are intended to enhance pedestrian access and circulation as well as help pedestrians feel more comfortable when walking in Stanislaus County.

A number of recommendations are made for infrastructure projects that should be implemented on a broad countywide basis. These projects were divided into several categories of improvements: Sidewalk Gaps, Curb Ramps, Signalized Intersections, Signal Timing, and Unsignalized Intersections. Following the Countywide project recommendations, a number of example project recommendations are identified. These projects seek to improve specific intersections, corridors, or other locations that were identified through the existing conditions and public input process as needed improvement areas. **Figure 5-1** shows an overview of pedestrian facility improvements including paths and specific pedestrian improvement projects. More details about specific improvement types are provided in the **Appendix B**.

Infill of Sidewalk Gaps

Sidewalk gaps are areas in Stanislaus County where there is no walkway, or the walkway ends abruptly, resulting in a discontinuous network. Areas without walkways may force pedestrians to walk along the edge of the roadway, or may cause pedestrians to cross at undesignated crossing locations. Stanislaus County should fill sidewalk gaps located near schools and transit stops. Where feasible, providing a continuous pedestrian sidewalk along roadways is recommended. It is also recommended that sidewalks be required for commercial, business, and industrial parks.

Reduction of Curb Radii

Historically roadway design standards called for wide curb radii at intersections to promote intersection capacity for motor vehicles. As a result, many of the County's intersections have corners that force pedestrians to walk further to cross the street than at intersections with small or medium turning radii. This design also allows vehicles to make right-turns at relatively high speeds compared to smaller intersections. The reduction of curb radii could be studied on a case-by-case basis.

Curb Ramp Improvements

Curb Ramps

An inventory of curb ramps was not conducted for this Plan. As a part of a curb ramp inventory, data on the slope, side slope, landing dimensions, and other attributes of the curb ramp are measured in the field. An analysis of this data considers compliance with current ADA regulations for slope, lip height and presence of tactile warnings ("truncated domes"). Retrofitting the cities non-compliant curb ramps is generally something the County or City will accomplish as part of roadway re-paving projects (ADA requires that curb ramps be installed or brought up to compliance during street overlays).

Truncated Domes

Truncated domes provide a cue to visually-impaired pedestrians that they are entering a street or intersection. Since 2002, ADA Guidelines have called for truncated domes on curb ramps.



Curb ramp with truncated domes

Although it is not required to install truncated domes at existing curb ramps that were built prior to 2002, it is recommended that the County continue installing these devices at high priority pedestrian locations and when re-paving and upgrading existing curb ramps to meet ADA guidelines. Truncated domes are a very visible improvement, and they are relatively inexpensive to install.

This page intentionally left blank

STANCOG NMTMP

Pedestrian Improvements

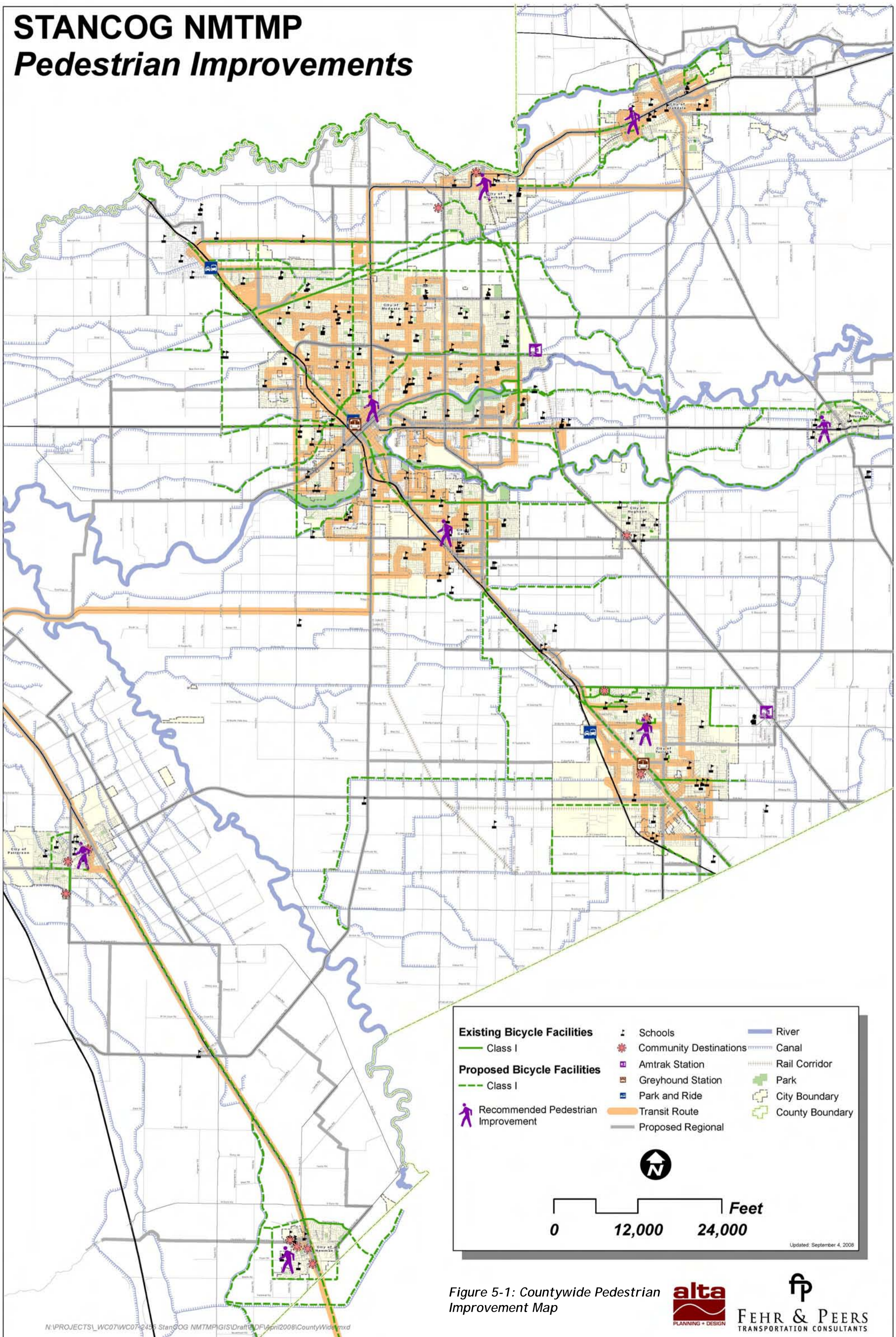
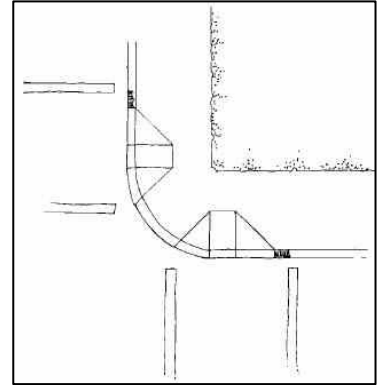

Figure 5-1: Countywide Pedestrian Improvement Map



Perpendicular Curb Ramps

Perpendicular curb ramps are designed so two ramps are included at intersection corners. Perpendicular ramps allow pedestrians and people in wheelchairs to access the sidewalk perpendicular to stopped traffic, and to enter into the crosswalk directly in their line of travel. Perpendicular ramps are not required by ADA or any other standard. However, perpendicular ramps are the preferred curb ramp style from a pedestrian standpoint since they provide the most direct access into the crosswalk. Perpendicular ramps do require more space to install than a single diagonal ramp, are more costly, and sometimes cannot be accommodated due to utilities or other obstructions at the corner. However, especially at major intersections in high pedestrian zones, it is recommended that they be installed where feasible.



Signalized Intersection Improvements

There are a variety of engineering improvements that can improve pedestrians' walking experience when crossing signalized intersections. All of these improvements are discussed in detail in **Appendix B**. A recommended improvement at signalized intersections is signal retiming. This improvement is described below.

Signal Timing

Signal timing is the amount of time each phase of a signal is allotted for vehicles to pass through or pedestrians to cross the street. Per the MUTCD, standard traffic engineering design assumes that pedestrians travel at 4.0-feet per second, which is used to determine the amount of time to assign to the pedestrian clearance interval. For slower pedestrians, such as the elderly and children, this assumed walking speed may result in them not being able to fully cross the street before the light changes. By adjusting the signal timing to a slower walking rate, slower pedestrian will have more time to cross the street.

Audible Signals

Audible signals provide a cue to visually-impaired pedestrians that there is a 'Walk' signal. Audible signals are usually chirping sounds and can also be the name of the street to cross. Sounds are activated by the pedestrian push-button. The MUTCD states that installation of audible signals should be based on an engineering study that considers:

- “Potential demand for accessible pedestrian signals
- A request for accessible pedestrian signals
- Traffic volumes during times when pedestrians might be present; including periods of low traffic volumes or high turn-on-red volumes.
- The complexity of traffic signal phasing.
- The complexity of intersection geometry.

Stanislaus County and its Cities should consider installing audible signals at signalized intersections.

Uncontrolled Crosswalk Improvements

Infrastructure improvements at uncontrolled crosswalk locations can help increase the visibility of pedestrians to motorists and improve the pedestrians' walking experience. These improvements are for both unmarked and marked crosswalks at intersections.

High-Visibility Crosswalk Markings

There are a variety of different striping styles for crosswalks. Generally in the County there are two different marking styles for pedestrian crosswalks: the standard “transverse” style, consisting of two parallel lines; and the “ladder” style consisting of the two parallel lines with perpendicular ladder bars striped across the width of the crosswalk. Ladder style crosswalks are used in locations where heightened pedestrian visibility is important, such as around school areas. As a Countywide policy, Stanislaus should encourage the installation of ladder crosswalk markings at all uncontrolled crosswalk locations where there are existing transverse style markings. The County should also encourage the installation of high-visibility ladder crosswalk markings at uncontrolled crosswalks on local streets adjacent to schools and at other locations, on a case-by-case basis.

Raised Crosswalks

As described in the MUTCD, raised crosswalks are a combination of speed hump or speed table and crosswalk, which raises a conventional crosswalk, with the goal of increasing visibility of the crosswalk and encouraging frequent users to get in the habit of slowing for the pedestrian crossing. Stanislaus should encourage the use of raised crosswalks at uncontrolled crosswalk locations where there is an existing marked crosswalk and a history of poor motorist awareness of and yielding at the existing crosswalk. Raised crosswalks are appropriate for roadways with lower traffic volumes and are not typically used on high-volume arterial streets. As a form of traffic calming, raised crosswalks should be installed in consultation with police and fire to ensure prompt access for emergency vehicles.

In-Street Yield to Pedestrian Signs

In-Street Yield to Pedestrian Signs are flexible plastic “paddle” signs installed in the center of a roadway to enhance a crosswalk at uncontrolled crossing locations. Stanislaus County should encourage the use of “paddle” crosswalk signs along downtown commercial streets and at selected school locations by installing new signs as needed and maintaining existing sign locations.

In-Pavement Crosswalk lights

This push-button activated device is designed to improve pedestrian safety by increasing motorist awareness of pedestrians at midblock crosswalk locations. When pedestrians push the button, lights imbedded in the pavement on either side of the crosswalk illuminate in a flashing pattern. In-pavement lights have been used at the Marin County Civic Center where they have been successful at improving motorist yielding to pedestrians in the crosswalk.

Stanislaus County should encourage the installation of in-pavement flashing lights at mid-block crosswalk locations.

Curb Extensions

Curb extensions, also called “bulbouts” to describe their shape, are engineering improvements intended to reduce pedestrian crossing distance and increase visibility. In addition to shortening the crosswalk distance, curb extensions serve to increase pedestrian visibility by allowing pedestrians to safely step out to the edge of the parking lane where they can see into the street, also making them more visible to oncoming drivers. Curb extensions can also improve safety by visually narrowing the roadway, cueing drivers to reduce their speed. Despite their advantages, curb extensions can require major re-engineering of the street, can be extremely costly, and are not appropriate for all situations. Stanislaus County should encourage the installation of curb extensions at crosswalk locations where appropriate.

Railroad Crossings

There are several railroad lines with at-grade crossings in Stanislaus County. At-grade crossings are where trains cross the street at the same level as vehicles and pedestrians. Improvements such as signals, reorientation of sidewalks, and truncated domes placed at the crossing can help alert pedestrians of possible train traffic. Stanislaus County should install and encourage the installation of truncated domes at all pedestrian crossings of train tracks. The

County should also consider improvements such as gates, fences, and other warning devices at locations with high pedestrian volumes.

5.5. Pedestrian Project Sheets

This section provides detailed descriptions of existing pedestrian conditions and makes recommendations for a number of specific improvements. Typical improvements for these areas include addition of new high-visibility ladder crosswalks, installation of curb extensions, and installation of in-pavement flashers. Curb ramps should be provided at all corners whether for new or upgraded crosswalk locations or new or existing sidewalks. Unless otherwise noted, all locations are presumed to have some kind of existing lighting, typically streetlights.

5.6. Ceres Improvement Project:

Central Avenue and Glenda Road

Study Area Description

The intersection of Central Avenue and Glenda Road is a focal point for automobile and Non-Motorized traffic. The intersection connects Ceres High School, the Farm Labor Center, and the residential neighborhood to the west. Glenda Road is an important link, connecting the residential neighborhood to the school and to Central Avenue. Central Avenue is a central corridor that connects the neighborhood to southern and northern Ceres and to State Route 99. The intersection is unsignalized and has one transverse crosswalk on the southern leg. The sidewalks along the Central Avenue Corridor are narrow.

Issues

- Glenda Road approaches Central Avenue at an angle, creating an intersection with a wide angle.
- The southern leg of the intersection has the intersection's only crosswalk.
- The sidewalks along Central Avenue on either side of Glenda Road are narrow.

Proposed Improvements



CERES HIGH SCHOOL AREA IMPROVEMENTS

- Construct curb extensions on the northwest, southwest, and southeast intersection corners. (\$200,000)
- Formalize the crosswalk and install in-pavement flashers. (\$76,200)
- Widen the sidewalks along the eastern side of Central Avenue between East Whitmore Avenue and Glenda Road. (\$32,200)
- Widen the sidewalks along the western side of Central Avenue between Glenda Road and Hollister Street. (\$36,00)

Cost

- \$345,200

5.7. Hughson Improvement Project:

This page intentionally left blank

This page intentionally left blank

5.8. Modesto Improvement Project:

J Street Corridor

Study Area Description

J Street is in the heart of historic downtown Modesto. The area is home to many entertainment businesses, such as The State Theatre of Modesto, and has significant pedestrian activity. Streetscape improvements have been recently installed along the corridor. 10th Street, a pedestrian only street, brings many people to the J Street corridor. J Street connects to McHenry Avenue, a major north-south corridor running through the center of the city. The majority of the intersections are controlled, however two are not. There were six pedestrian collisions along this corridor between 2002 and 2007.

Issues

- Pedestrian collisions.
- Uncontrolled intersections.

Proposed Improvements



J STREET CORRIDOR IMPROVEMENTS



- Install pedestrian countdown signals on J Street on 9th through 16th Streets (\$41,600)
- Install high visibility crosswalks at 13th and 15th Streets. (\$4,800)
- Install “Yield to Pedestrian” signs at 13th and 15th Street crosswalks. (\$800)
- Consider study to evaluate feasibility of controlling the 13th and 15th Street intersections.

Cost

- \$47,200

5.9. Newman Improvement Project:

Hoyer Road and Silva Avenue

Study Area Description

Yolo Middle School is located on Hoyer Road between Silva Avenue and Harvey Road. The north side of Hoyer, west of Silva, has an inconsistent street width. The property line of the residential lots east of the school does not align with the school property line. As a result, the sidewalk near the residential properties does not connect with the sidewalk leading to the school. Further west, an informal sidewalk has been constructed in front of two residential buildings and an empty lot to the east of the school. Walking space has been designated with curb stops running parallel to the roadway. The north leg of the intersection is wide.

Issues

- Unconnected sidewalk creates pedestrian hazards.
- Informal sidewalk along Hoyer Road.
- Long crossing distance on Hoyer Road across Silva Avenue.

Proposed Improvements



YOLO MIDDLE SCHOOL AREA IMPROVEMENTS

- Align the sidewalk along the northwest corner to meet the lot line of the school property to make for better sidewalk connectivity. (\$9,000)
- Widen the sidewalk on the northern side of Hoyer from Silva to the school entrance. (\$12,375)
- Construct curb extension on the north east corner of Hoyer and Silva should be constructed to shorten the crossing distance. (\$100,000)

Cost

- \$121,375

5.10. Oakdale Improvement Project:

West F Street and South Lee Avenue

Study Area Description

West F Street is a high volume four lane roadway. It is intersected by Lee Avenue which connects the adjoining residential developments to West F Street shopping and neighboring cities. The intersection is uncontrolled and has one crosswalk on the eastern side of West F Street. In-pavement flashers are controlled by a pedestrian push button. The crossings of the intersection are wide. There is a sidewalk gap on the south west corner of the intersection.

Issues:

- Long crossing distances without pedestrian refuge on all legs of the intersection.
- Pedestrian visibility for drivers on West F Street.
- In-pavement flasher activation panel is not easily accessible.
- Lack of sidewalk on the southwest corner of the intersection.

Proposed Improvements



WEST F STREET AND LEE AVENUE INTERSECTION IMPROVEMENTS

- Construct curb extensions on all four corners. (\$250,000)
- Install a high visibility crosswalk with in-pavement flashers on the eastern leg of the intersection. (\$1,200)
- Construct a median island with refuge on West F Street, east side of intersection. (\$75,000)
- Realign pedestrian activated crossing to face sidewalk.

Cost:

- \$356,200

5.11. Patterson Improvement Project:

Las Palmas Avenue and 7th Street

Study Area Description

The intersection of 7th Street and Las Palmas is a focal point for vehicular and pedestrian access to the adjacent Las Palmas Elementary School. There are three legs to the intersection. Las Palmas connects the area to the City's downtown while 7th Street is a connection to residential areas. The intersection has wide crossings. On the north side of Las Palmas Avenue between 7th and 9th Streets, there is no formal sidewalk.

Issues

- Long crossing distances at the intersection of Las Palmas Avenue and 7th Street.
- Lack of a sidewalk on the northern side of Las Palmas Avenue between 7th and 9th Street.

Proposed Improvements



LAS PALMAS ELEMENTARY SCHOOL AREA IMPROVEMENTS

- Construct curb extensions should be constructed on all corners of the 7th Street and Las Palmas Avenue intersection. (\$250,000)
- Install a sidewalk on the north side of Las Palmas between 7th and 9th Streets between the street edge and the beginning of the tree line. This area should be designed to be a designated drop-off area for parents dropping off and picking up their children from school. (\$36,000)

Cost

- \$286,000

5.12. Riverbank Improvement Project:

Patterson Road between Roselle and Terminal

Study Area Description

This project encompasses a corridor along Patterson Road between Roselle Avenue and Terminal Avenue. The project area is just south of the downtown business district, is along a StaRT route and includes a StaRT bus stop. The corridor is a two-lane roadway intersected by a rail line and is bordered on the south by many industrial uses. The northern side of the corridor is bordered by a rail line, has no curb, and has no formal sidewalk. The southern side of the corridor is mostly uncurbed and is intermixed with unpaved and paved pedestrian areas. There is no formal sidewalk. At the south eastern end of this corridor the roadway is curbed. Property line fences abut the curb. The rail crossing between Roselle Avenue and 1st Street is wide and does not have pedestrian amenities.

Issues

- Lack of sidewalk on northern side of the corridor.
- Incomplete and informal sidewalk on the southern side of the corridor.
- Lack of public right-of-way on south eastern end of the corridor.
- Long pedestrian crossing distance across rail.

Proposed Improvements



PATTERSON ROAD IMPROVEMENTS

- Construct a sidewalk on the northern side of Patterson Road between Roselle Avenue and Terminal Avenue. (\$119,250)
- Construct a sidewalk on the southern side of Patterson Road between Roselle Avenue and Terminal Avenue. (\$119,250)
- Install truncated domes on rail crossing. (\$3,200)
- Install pedestrian signal heads at rail crossing. (\$3,200)

Cost

- \$244,900

5.13. Turlock Intersection Improvement:

Dels Lane and West Monte Vista Avenue

Study Area Description

The intersection of West Monte Vista Avenue and Dels Lane is wide and has significant vehicular traffic. West Monte Vista Avenue has four lanes of automobile traffic and turn pockets while Dels Lane has two lanes of traffic. One entrance to California State University, Stanislaus is through this intersection. The pedestrian environment includes crosswalks at all crossings and curb ramps. The curb ramps do not align with the crosswalks. The Dels Lane corridor has about 1500 feet of sidewalk gaps and is missing a two curb ramps.

Issues

- Curb ramps do not align with crosswalks.
- Long crossing distances across West Monte Vista Avenue.
- Long crossing distances across Hawkeye Avenue.
- Sidewalk gaps along Dels Lane.

Proposed Improvements

W Monte Vista Avenue and Dels Lane

- Construct curb extensions on all corners of the intersection. (\$250,000)
- Align curb ramps with crosswalks.
- Install pedestrian count down signals. (\$6,400)

Dels Lane Corridor

- Fill sidewalk gaps along corridor. (\$67,500)
- Install two curb ramps. (\$10,000)

W Hawkeye Avenue and Dels Lane

- Extend the medians to function as a pedestrian refuge. (\$60,000)
- Install pedestrian count down signals. (\$6,400)

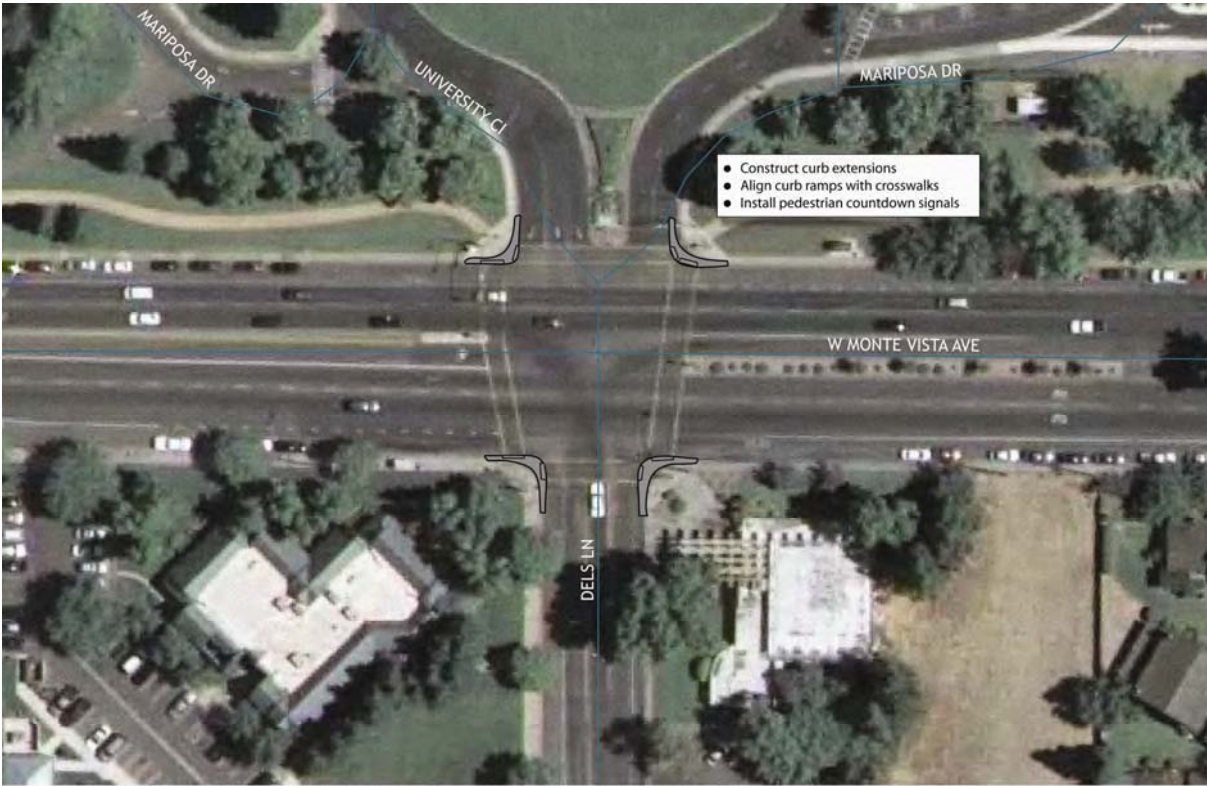

W MONTE VISTA AVE AND DELS LANE INTERSECTION IMPROVEMENTS

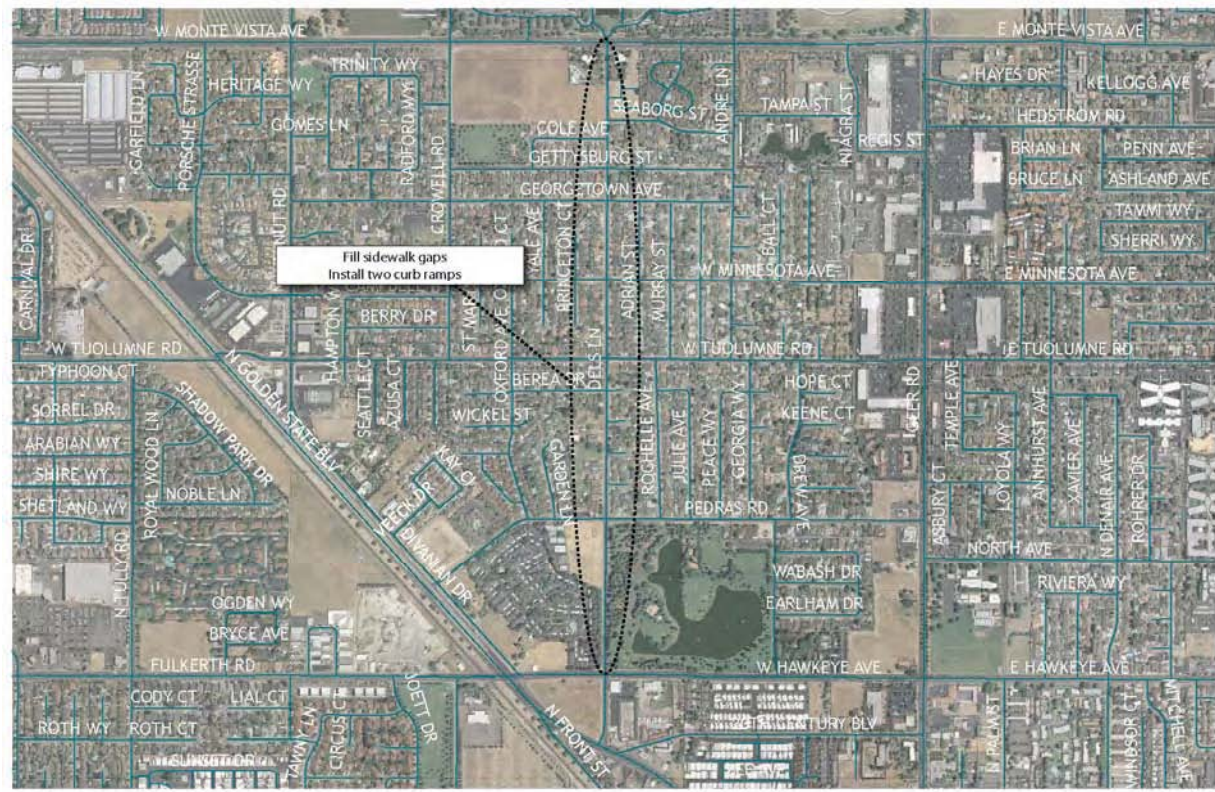

DELS LANE COORIDOR IMPROVEMENTS





W HAWKEYE AVENUE AND DELS LANE INTERSECTION IMPROVEMENTS

Cost

- \$400,300

This page intentionally left blank

5.14. Waterford Improvement Project:

Yosemite Boulevard and North Pasadena Avenue

Study Area Description

Yosemite Boulevard is a high volume roadway that serves as a connection between Modesto and Ceres to Waterford. Pasadena Avenue crosses Yosemite Blvd and connects neighboring communities to the greater Waterford area. The intersection is uncontrolled, has no crosswalks, and there are numerous sidewalk gaps in the immediate vicinity.

Issues

- Heavy traffic volumes on Yosemite Boulevard.
- Long crossing distance across Yosemite Boulevard.
- Lack of crosswalks.
- Sidewalk gaps along Yosemite Boulevard and North Pasadena Avenue.

Proposed Improvements



YOSEMITE BLVD AND PASADENA AVE INTERSECTION IMPROVEMENTS

- Install high visibility cross walk on Yosemite, on the west leg of the intersection. (\$1,200)
- Fill sidewalk gaps along Yosemite Blvd West, east and west of Pasadena. (\$96,525)
- Fill sidewalk gaps on N Pasadena Avenue, north of Yosemite. (\$45,000)
- Construct curb extensions on the north-west and north-east corners of intersection. (\$200,000)

Cost

- \$342,725

This page intentionally left blank

6. Safety and Education Programs

6.1. Existing Programs

Bicycle Safety Education Programs

Education is an important element in increasing bicycling while also improving safety. Although the most effective way to improve the safety of cycling is simply to improve the quality of Stanislaus County’s bikeway facilities, bikeways cannot do it alone. There is also a need for proper education of both youth and adult cyclists and motorists. Education of all roadway user groups can address specific collision types common for bicycles. Among others, safety and education programs can take the form of Safe Routes to Schools in-class instruction, adult “Street Skills” classes that teach safe bicycle operation and “Share the Road” outreach that targets both motorists and cyclists equally. More details about proposed programs can be found in subsequent chapters.

The Family Cycling Festival is an annual bicycling promotion in downtown Modesto. The event has been held since 1996 and consists of a bicycle rodeo and safety education course. It is held in conjunction with Bike to Work Week, which promotes bicycling as an alternate mode of transportation. The Family Cycling Festival is co-sponsored by the Downtown Improvement District, City of Modesto Rideshare, Modesto Police Department, Modesto Recreation and Neighborhood Connection Department, San Joaquin Valley Air Pollution Control District, Center for Human Services, Stanislaus County, Stanislaus County Bicycle Club, Valley Sporting Goods and Delta Cyclery.

Table 6-1 summarizes bicycle safety and education programs that were offered in Stanislaus County as of 2007:

Table 6-1: Bicycle Safety Education Programs

Agency	Contact Person	Program Functions
Family Cycling Festival	Megan Distaso, City of Modesto mdistaso@modestogov.com; 529-9303 or 571-5193	Teach cyclists safe riding skills through a bicycle rodeo and safety education course, and promote cycling through races and demonstrations
Bike to Work Week/Bike to Work Day Event	Megan Distaso, City of Modesto mdistaso@modestogov.com	Promote bicycling as an alternate mode of transportation
Stanislaus County’s Center for Human Services: “On the Safe Side” program (funded through the Children and Families Commission)	Liz Perez, Program Specialist with the Center for Human Services, (209) 526-1476	Pedestrian and bicycle safety education programs for children 0-5 years old. PC, the talking Patrol Car, visits schools and child daycare centers teaching kids how to ride their bicycles safely and why they need to wear bicycle helmets. Children also learn how to safely walk across the street.

Encouragement and Support Programs

Support Programs

Stanislaus County is home to many bicycle repair, supply and rental shops that can offer cyclist support. Cycling clubs can also provide support and encouragement. The Stanislaus County Bicycle Club was formed in 1982 to promote recreational bicycling safety, touring, racing, mountain biking, tandem riding, and commuting. The club is based in Modesto, and meets monthly. The June, July, August, and September meetings are family-oriented, usually

being staged at local parks with an organized ride available before dinner. The club is affiliated with the League of American Bicyclists and offers clinics on effective cycling, maintenance and safety. The club offers rides on Saturdays and Sundays at a variety of distances and speeds. The club organizes the annual Cheese and Wine Century Ride, held in October in Riverbank, in conjunction with the Annual festival.

Events

Events are an excellent way to promote awareness of bicycling for transportation and recreation. The following events have been/will be held in Stanislaus County.

Cheese and Wine Century Ride: The Stanislaus County Bicycle Club organizes this annual ride, held in October in Riverbank, in conjunction with the Annual festival. The Ride includes three routes (110 miles, 62 miles, and 25 miles) for varying skill levels traversing the Central Valley farmlands and grasslands to the Central Sierra Nevada foothills.

Walk to School Day: The Stanislaus County Safe Communities Coalition coordinates annual Walk to School Day activities in October at elementary schools throughout the county. The Walk to School Day event involves approximately 1,500 students from Wakefield, Tuolumne, Orville Wright, Robertson Road, Marshall, Brown, Cloverland, Denair, Franklin and Shackelford Elementary Schools. Members of the Coalition include County and City departments, law enforcement agencies, community based organizations, local businesses and grocers, schools, and community members. The program's goal is to raise awareness of pedestrian and bicycle safety throughout Stanislaus County. In addition to Walk to School Day, activities include promotional assemblies where students learn about pedestrian and bicycle safety, and "walkability" checklists, to help the Safe Communities Coalition identify areas of concern for pedestrian safety in our neighborhoods.

6.2. Proposed Programs

Safe Routes to Schools

Safe Routes to Schools (SR2S) is a program designed to reduce local congestion around schools by increasing the number of children walking and biking to school. A SR2S program can integrate health, fitness, traffic relief, environmental awareness and safety under one program. It is an opportunity for parents to work closely with their children's school, the community and the local government to create a healthy lifestyle for children and a safer and cleaner environment for all residents. Details about SR2S funding opportunities are found in the funding section of this report. A typical program has four components:

- **Encouragement** - Events, contests and promotional materials are incentives that encourage children and parents to try walking and biking.
- **Education** - Classroom lessons teach children the skills necessary to navigate through busy streets and persuade them to be active participants in the program. Safe Routes Instructors have developed curriculum which includes an on the bike instruction, walking instruction and lessons on health and the environment.
- **Engineering** - A Certified Traffic Engineer typically assists schools in developing a plan to provide a safer environment for children to walk and bike to school. This plan includes engineering improvements, enforcement enhancements and outreach to drivers.
- **Enforcement** - Working with local law enforcement, the program increases police presence around the schools while developing public education efforts that increase drivers' awareness of the behaviors that endanger children. This type of program can be funded through either outside grants or local funding sources.

Walking or biking to school gives children a taste of freedom and responsibility, allows them to enjoy the fresh air and the opportunity to get to know their neighborhood, while arriving at school alert, refreshed and ready to start their day. However, only 13% of America's children walk or bike to school (US Centers for Disease Control and Prevention). **Table 6-2** lists bikeways proposed in this plan within a quarter mile of a school. This list could be used as a starting point for developing SR2S grant applications. A successful Safe Routes to Schools program improves the health and safety of pupils and the surrounding neighborhood. Students increase their physical activity, potentially improving their alertness and behavior. California studies have shown that children who are physically active perform better academically (California Department of Education, December 2002).

Communities elsewhere in California have experienced reduced traffic congestion, reduced collision in and around schools, and decreased speed in residential neighborhoods. Children learn valuable traffic safety skills and responsibility and more people of all ages are able to walk and bike in the neighborhood as a result of improved access.

Table 6-2: Schools Near Proposed Bikeways

City	School	Distance to Bikeway (Feet)	Bikeway	Bikeway Class
Ceres	Argus High	998	El Camino	II
Ceres	Argus High	890	Pine St.	II
Ceres	Blaker-kinser Junior High School	370	Blaker Rd.	II
Ceres	Caswell Elementary School	909	Richard Wy.	II
Ceres	Central Valley High School	771	Central Ave.	II
Ceres	Ceres High School	833	Central Ave.	II
Ceres	Ceres High School	1297	Herndon Rd.	II
Ceres	Don Pedro Elementary School	544	Central Ave.	II
Ceres	Don Pedro Elementary School	712	E Service Rd.	II
Ceres	Hensley Junior High School	132	Moffett Rd.	II
Ceres	Hidahl Elementary School	1025	Canal	I
Ceres	Parks Elementary School	838	River Rd.	II
Ceres	Sinclair Elementary School	384	Hackett Rd.	II
Ceres	Sinclair Elementary School	322	Morgan Rd.	II
Ceres	Vaughn Elementary School	973	Boothe Rd.	II
Ceres	Vaughn Elementary School	977	Fowler Rd.	II
Ceres	Vaughn Elementary School	160	Helen Perry Rd.	II
Ceres	Walter White Elementary School	632	Magnolia St.	II
Ceres	White Elementary School	88	6th St.	II
Ceres	White Elementary School	313	Magnolia St.	III/II
Ceres	Whitmore Charter High School	800	Boothe Rd.	II
Ceres	Whitmore Charter School	791	Moore Rd.	I
Empire	Empire Elementary School	1125	S Santa Fe Ave.	III
Empire	Empire Elementary School	533	Yosemite Blv.	III
Hughson	Dickens Continuation High School	332	Charles St.	III
Hughson	Dickens Continuation High School	1023	Fox Rd.	III
Hughson	Fox Road Elementary School	327	Euclid Ave.	II
Hughson	Fox Road Elementary School	112	Fox Rd.	II
Hughson	Fox Road Elementary School	1209	Locust St.	III
Hughson	Fox Road Elementary School	988	Orchard Ln.	III
Hughson	Fox Road Elementary School	1308	Proposed Class I	I

City	School	Distance to Bikeway (Feet)	Bikeway	Bikeway Class
Hughson	Fox Road Elementary School	479	Thomas Taylor Dr.	III
Hughson	Hughson Christian School	307	E Hatch Rd.	I
Hughson	Hughson Christian School	209	Tully Rd.	III
Hughson	Hughson Elementary School	228	E Whitmore Ave.	II
Hughson	Hughson Healthy Start	419	Charles St.	II
Hughson	Hughson Healthy Start	263	Hughson Ave.	II
Hughson	Hughson Healthy Start	1008	Locust St.	III
Hughson	Hughson Healthy Start	197	S Santa Fe Ave.	II
Hughson	Hughson Healthy Start	899	Tully Rd.	II
Hughson	Hughson High School	455	7th St.	II
Hughson	Hughson High School	592	Proposed Class III	III
Keyes	Keyes Elementary School	841	Class I Connector	I
Keyes	Keyes Elementary School	134	N Golden State Blv.	III
Keyes	Summit Charter Academy	648	Glasgow Dr.	II
Modesto	Adkison Elementary School	889	Richland Ave.	II
Modesto	Alice Stroud Elementary School	156	MID Lateral No 2	I
Modesto	Alice Stroud Elementary School	406	Mid Lateral No. 2	I
Modesto	Baptist Elementary School	656	Mid Lateral No. 7	I
Modesto	Baptist Elementary School	201	Shawnee Dr.	III
Modesto	Beard Elementary School	356	Bowen Ave.	III
Modesto	Beard Elementary School	412	Virginia Railroad Trail	I
Modesto	Bret Harte Elementary	354	TID Lateral No. 1	I
Modesto	Burbank Elementary School	1175	Harris Ave.	III
Modesto	Burbank Elementary School	238	Paradise Rd.	II
Modesto	Capistrano Elementary School	264	Capistrano Dr.	III
Modesto	Capistrano Elementary School	435	El Pasado Dr.	III
Modesto	Capistrano Elementary School	539	Poppypatch Dr.	III
Modesto	Capistrano Elementary School	925	San Ignacio Ave.	III
Modesto	Chrysler Elementary School	796	Budd St.	III
Modesto	Chrysler Elementary School	373	Conant Ave.	III
Modesto	Daniel J. Savage Middle School	580	Maid Mariane Ln.	II
Modesto	Daniel J. Savage Middle School	279	Merle Ave.	II
Modesto	Dietrich Elementary School	851	Pelandale Ave.	I
Modesto	Eisenhut Elementary School	545	Pembroke Dr.	III
Modesto	Eisenhut Elementary School	361	Sheldon Dr.	III
Modesto	Elizabet Ustach Middle School	474	Bear Cub Ln.	II
Modesto	Elizabet Ustach Middle School	1018	Temescal Dr.	II
Modesto	Elliott Alternative Education Center	335	Sunrise Ave.	III
Modesto	Enochs High School	646	Millbrook Ave.	II
Modesto	Enochs High School	533	Sylvan Ave.	II
Modesto	Enslen Elementary School	1215	Virginia Ave.	II
Modesto	Franklin Elementary School	383	Maze Blv.	I
Modesto	Franklin Elementary School	451	Mid Lateral No. 5	I
Modesto	Franklin Elementary School	484	N Emerald Ave.	III
Modesto	Fred Beyer High School	821	Bridgewood Wy.	III
Modesto	Fred Beyer High School	821	Palmwood Dr.	III

City	School	Distance to Bikeway (Feet)	Bikeway	Bikeway Class
Modesto	Freedom Elementary	395	Sharon Ave.	II
Modesto	Future Elementary School	522	Aria Wy.	II
Modesto	Future Elementary School	428	Caden Dr.	II
Modesto	Future Elementary School	383	Hillglen Ave.	II
Modesto	Future Elementary School	1039	Wood Sorrel Dr.	II
Modesto	Hanshaw Middle School	721	Dallas St.	III
Modesto	Hart-ransom School	270	Dakota Ave.	I
Modesto	Hart-ransom School	153	Shoemake Ave.	II
Modesto	Hughes Elementary School	1193	Dry Creek Dr.	III
Modesto	Hughes Elementary School	340	Mechalys Wy.	III
Modesto	Hughes Elementary School	355	N Mc Clure Rd.	III
Modesto	Hughes Elementary School	400	Penny Ln.	III
Modesto	James Enochs High School	927	Modesto City Limits	II
Modesto	Johansen High School	395	Creekwood Dr.	III
Modesto	Johansen High School	386	Norseman Dr.	III
Modesto	La Loma Junior High School	1316	Covena Ave.	III
Modesto	La Loma Junior High School	869	Oakbrook Dr.	III
Modesto	Lakewood Elementary School	680	Roselle Ave.	II
Modesto	Mark Twain Junior High School	420	California Ave.	II
Modesto	Mark Twain Junior High School	445	Panama Dr.	III
Modesto	Marshall Elementary School	974	Chicago Ave.	III
Modesto	Marshall Elementary School	1011	Rouse Ave.	III
Modesto	Marshall Elementary School	324	S Martin Luther King Dr.	III
Modesto	Martone Elementary School	324	Chapparal Pl.	III
Modesto	Martone Elementary School	877	Morse Rd.	II
Modesto	Mary Ann Sanders Elementary	353	Kodiak Dr.	II
Modesto	Mary Ann Sanders Elementary	941	Litt Rd.	II
Modesto	Mary Lou Dietrich Elementary School	724	Marsala Wy.	III
Modesto	Mcs Nutrition Services	264	N Carpenter Rd.	II
Modesto	Mcs Nutrition Services	347	Woodland Ave.	II
Modesto	Mildred Perkins School	394	Blue Bird Dr.	III
Modesto	Mildred Perkins School	1258	Gagos Dr.	III
Modesto	Mildred Perkins School	845	Nightingale Dr.	III
Modesto	Mildred Perkins School	404	Setrok Dr.	III
Modesto	Mildred Perkins School	337	Snyder Ave.	III
Modesto	Modesto Christian Elementary School	749	Montclair Dr.	III
Modesto	Modesto High School	589	1st St.	III
Modesto	Modesto High School	668	G St.	III
Modesto	Modesto High School	257	H St.	III
Modesto	Muncy Elementary School	354	Janna Ave.	III
Modesto	Orchard Elementary School	732	Canal	I
Modesto	Orchard Elementary School	1030	Oakdale Rd.	III
Modesto	Orville Wright Elementary	563	Hillside Dr.	III
Modesto	Orville Wright Elementary	1096	Tioga Dr.	III
Modesto	Pearson Elementary School	145	Mid Lateral No. 4	I
Modesto	Peter Johansen High School	576	Claus Rd.	I

City	School	Distance to Bikeway (Feet)	Bikeway	Bikeway Class
Modesto	Robertson Road Elementary	333	Hammond St.	III
Modesto	Robertson Road Elementary	423	Robertson Rd.	III
Modesto	Sanders Elementary School	203	Fine Ave.	II
Modesto	Shakelford Elementary	359	Crows Landing Rd.	II
Modesto	Shakelford Elementary	1307	W Hatch Rd.	II
Modesto	Shakelford Elementary	1257	W Hatch St.	I
Modesto	Sherwood Elementary School	339	Claremont Ave.	III
Modesto	Somerset Middle School	657	Floyd Ave.	III
Modesto	Sonoma Elementary School	846	Laramie Dr.	III
Modesto	Sonoma Elementary School	1101	Peppermint Dr.	III
Modesto	Sonoma Elementary School	436	Sonoma Ave.	III
Modesto	St. Stanislaus Parish School	623	Maze Blv.	I
Modesto	St. Stanislaus Parish School	508	S Carpenter Rd.	I
Modesto	Standiford Elementary School	1107	Codding Dr.	III
Modesto	Stanislaus Elementary School	394	Claribel Rd.	I
Modesto	Stanislaus Union District Office	67	Carver Rd.	III
Modesto	Stockard Coffee Elementary School	361	Mable Ave.	III
Modesto	Stockard Coffee Elementary School	706	Sylvan Meadows Dr.	III
Modesto	Stroud Elementary School	273	Frazine Rd.	III
Modesto	Sylvan School District Office	291	Dragoo Park Dr.	III
Modesto	Sylvan School District Office	1265	W Union Ave.	III
Modesto	Tuolumne Elementary School	241	Herndon Rd.	III
Modesto	Tuolumne Elementary School	1120	River Rd.	III
Modesto	Ustach Middle School	436	Lincoln Oak Dr.	II
Modesto	Wilson Elementary School	669	La Loma Ave.	III
Modesto	Wilson Elementary School	329	Las Palmas Ave.	III
Modesto	Wilson Elementary School	1002	Miller Ave.	III
Modesto	Wilson Elementary School	1205	S Santa Cruz Ave.	III
Modesto	Wilson Elementary School	1072	S Santa Rosa Ave.	III
Newman	Central California Child Development	770	Inyo Ave.	II
Newman	Hunt Elementary School	571	Fig Ln.	II
Newman	New Beginnings Day School	1029	Kern St.	II
Newman	New Beginnings Day School	596	Orestimba Rd.	II
Newman	Von Renner Elementary School	1046	Canyon Creek Dr.	II
Newman	Von Renner Elementary School	1072	Merced St.	II
Newman	Von Renner Elementary School	855	T St.	II
Newman	Von Renner Elementary School	1096	Upper Rd.	II
Newman	West Side Valley High (continuation)	495	SR 33	I
Newman	Yolo Junior High School	66	Class II Connector	II
Newman	Yolo Junior High School	478	Hoyer Rd.	II
Newman	Yolo Junior High School	474	Hoyer Rd.	II
Oakdale	Alpha Omega Christian School	103	S 1st Ave.	II
Oakdale	Alpha Omega Christian School	81	W G St.	III
Oakdale	East Stanislaus High School	630	N Oak Ave.	III
Oakdale	East Stanislaus High School	808	W J St.	II
Oakdale	East Stanislaus High School	619	Wood Ave.	III

City	School	Distance to Bikeway (Feet)	Bikeway	Bikeway Class
Oakdale	Fair Oaks Elementary School	158	N Lee Ave.	III
Oakdale	Fair Oaks Elementary School	734	Pontiac St.	III
Oakdale	Oakdale Head Start	702	C St.	III
Oakdale	Oakdale Head Start	708	Valley View Dr.	I
Oakdale	Oakdale High School	1197	W J St.	III
Oakdale	Oakdale Junior High School	728	S Maag Ave.	II
Oakdale	Sierra View Elementary School	1103	Post Ave.	I
Oakdale	Sierra View Elementary School	1103	Sierra Rd.	II
Patterson	Creekside Middle School	364	American Eagle Ave.	II
Patterson	Creekside Middle School	703	Class I	I
Patterson	Creekside Middle School	205	Peregrine Dr.	II
Patterson	Del Puerto High School	206	M St.	II
Patterson	Del Puerto High School	559	Ward Ave.	II
Patterson	Las Palmas Elementary School	1195	S Del Puerto Ave.	III/II
Patterson	Las Palmas Elementary School	1081	S El Circulo.	II
Patterson	Las Palmas Elementary School	718	W Las Palmas Ave.	II
Patterson	Las Palmas Elementary School	1084	W Las Palmas Ave.	II
Patterson	Patterson High School	877	James Burke Ave.	II
Patterson	Patterson High School	269	N 9th St.	III/II
Riverbank	California Avenue Elementary School	1197	Kentucky Ave.	II
Riverbank	Cardoza Middle School	1320	North Side of Stanislaus River	I
Riverbank	Cornerstone Christian School	273	Sierra St.	III
Riverbank	Cornerstone Christian School	1045	Terminal Ave.	II
Riverbank	Migrant Education High School	264	Claus Rd.	II
Riverbank	Rio Altura Elementary School	532	Candlewood Pl.	III
Riverbank	Rio Altura Elementary School	287	Estelle Ave.	III
Riverbank	Rio Altura Elementary School	1061	Jackson Ave.	III
Riverbank	Rio Altura Elementary School	1087	Sierra St.	III
Riverbank	Rio Altura Elementary School	128	Stanislaus St.	III
Riverbank	Riverbank High School	739	Class I Connector	I
Salida	Salida Elementary School	257	Covert Rd.	III
Salida	Salida Elementary School	460	Finney Rd	III
Salida	Salida Middle School	473	Kiernan Ave.	III
Salida	Salida Union District Office	746	Parallel to SR 99/8th St.	I
Turlock	Brown Elementary	713	W Minnesota Ave.	III
Turlock	Crane School	83	Cahill Ave./Zinfandel Ln.	III
Turlock	Crane School	1050	Crane Ave.	III
Turlock	Crane School	233	Minaret Ave.	III
Turlock	Crane School	990	N Palm St.	III
Turlock	Crowell Elementary	1000	Annhurst Ave.	III
Turlock	Crowell Elementary	842	Baylor Ave.	III
Turlock	Crowell Elementary	344	Class I Connector	I
Turlock	Crowell Elementary	375	Loyola Wy.	III
Turlock	Crowell Elementary	927	N Palm St.	III
Turlock	Crowell Elementary	375	North Ave.	III

City	School	Distance to Bikeway (Feet)	Bikeway	Bikeway Class
Turlock	Dennis Earl Elementary	1020	Fosberg Rd.	III
Turlock	Dennis Earl Elementary	419	N Olive Ave.	III
Turlock	Dennis Earl Elementary	905	N Olive Ave.	III
Turlock	Mountain View Middle School	541	Crows Landing Rd.	III
Turlock	Mountain View Middle School	320	West Main St.	III
Turlock	Osborn Elementary School	628	Columbia St.	III
Turlock	Osborn Elementary School	1092	High St. Extension	I
Turlock	Osborn Elementary School	242	N Soderquist Rd.	II
Turlock	Osborn Elementary School	325	S Soderquist Rd.	III
Turlock	Pitman High School	452	Class II Connector	I
Turlock	Pitman High School	988	Mountain View Rd.	II
Turlock	Pitman High School	402	N Kilroy Rd.	II
Turlock	Pitman High School	695	Paseo De Leon	I
Turlock	Stanislaus Academy	987	S Golden State Blv.	I
Turlock	Turlock Christian Elementary	813	N Johnson Rd.	II
Turlock	Turlock Christian Elementary	1099	N Quincy Rd.	III
Turlock	Turlock Christian Schools	1183	E Monte Vista Ave.	I
Turlock	Valley Oaks School For Dyslexia	165	W Linwood Ave.	II
Turlock	Wakefield Elementary School	253	S Orange St.	III
Turlock	Wakefield Elementary School	133	South Ave.	III
Turlock	Walnut Elementary Education Center	594	Class II Connector	I
Turlock	Walnut Elementary Education Center	844	Class II Connector	I
Turlock	Walnut Elementary Education Center	1087	Paseo Belleza	I
Waterford	Moon Elementary School	365	WID Canal	I
Waterford	Waterford Community Day School	559	Yosemite Blv.	II
Waterford	Waterford Community Day School	405	Yosemite Blv.	II
Waterford	Waterford Community Day School	556	Yosemite Blv.	II
Waterford	Waterford Community Day School	1030	Yosemite Blv.	II
Waterford	Waterford High School	851	Yosemite Blv.	II
Waterford	Waterford Middle School	1222	Yosemite Blv.	II
Waterford	Waterford Middle School	1295	Yosemite Blv.	II

Adult Bicycle Education

Many less-experienced adult bicyclists are unsure how to negotiate intersections and ride with traffic on streets and roads. Adult education efforts which are sponsored by government agencies, major employers, local bike enthusiasts or other volunteer groups, can help address this need. An annual or semi-annual class could be offered free of charge to provide information on how to avoid collisions and citations, how to ride safely, improve visibility and the legal rights of cyclists. Instructors from elsewhere in the state or qualified local instructors or volunteers could teach this class to cyclists, tailored to local needs and issues. Future expansion ideas could include adding on-the-bike training.

Share the Road Outreach Program

Public agencies such as the National Highway Traffic Safety Administration have begun to address the lack of safety education targeting both bicyclists and motorists. Many cyclists are not aware of basic road etiquette when sharing

the road with drivers. Many motorists mistakenly believe that bicyclists do not have a right to ride in travel lanes and that they should be riding on sidewalks. Many motorists also do not understand the concept of ‘sharing the road’ with bicyclists, or why a bicyclist may need to ride in a travel lane if there is no shoulder or it is full of gravel or potholes.

It is recommended that Stanislaus County develop a Share the Road outreach program to benefit both motorists and cyclists. The Share the Road program could be a partnership between local cycling groups and Stanislaus County Law Enforcement. Stanislaus County or CCOG could seek annual funding to develop the following elements of the Share the Road Program, implemented in a phased approach:

Share the Road presentation: In development by NHTSA, this PowerPoint presentation is being developed as a part of a national toolkit for public outreach and includes information on the rights and responsibilities of cyclists and drivers and focuses on ways each group can behave courteously to avoid collisions. The presentation will be available from NHTSA for presentation to the public and as a training device, for example, for law enforcement or transit drivers. The presentation is designed to be used by volunteer presenters who are not experts in the field of bicycle safety.

Checkpoints: At checkpoints, uniformed police, highway patrol officers and volunteers from local cycling groups stop drivers and cyclists and provide them with share the road safety flyers. These checkpoints are usually targeted at areas with high cycling use or a high number of collisions or reports of close calls and perceived danger to cyclists. Checkpoints, while coordinated with County law enforcement, are typically implemented at a local level.

Other Bicycle Support Programs and Activities

Without community support, a bicycle plan lacks the key resources that are needed to ensure implementation over time. While the County Public Works Department may be responsible for designing and constructing physical improvements, strategies for community involvement will be important to ensure broad-based support--which translates into political support--which can help secure financial resources. This may require involvement by the private sector in raising awareness of the benefits of bicycling and walking range from small incremental activities by non-profit groups, to efforts by the largest employers in the County. Specific programs are described below.

Earn-a-Bike Program

Sponsored by local cycling groups and bicycle shops in partnership with schools and other public agencies, this program could be modeled on the existing national ‘Trips for Kids’ program. The program’s dual mission is to train young people (ages 12 to 18) how to repair bicycles as part of a summer jobs training effort or after-school program.

Bicycles are an excellent medium to teach young people the fundamentals of mechanics, safety, and operation. Young people can use these skills to maintain their own bicycles, or to build on related interests. The program is should be staffed by volunteers from local cycling organizations and bicycle shops, who can help build an interest in bicycling as an alternative to driving. The seed money to begin this program often comes from a local private funding source. The proposal submitted to this source should clearly outline the project objectives, operating details, costs, effectiveness evaluation, and other details. The bicycles themselves could be derived from unclaimed stolen bicycles from the police or sheriff’s departments, or from donated bicycles. The program would need to qualify as a Section 501c(3) non-profit organization to offer tax deductions.

Community Adoption

Programs to have local businesses and organizations ‘adopt’ a Class I pathway similar to the adoption of segments of the Interstate Highway system are emerging across the country. Small signs located along the pathway would identify supporters, acknowledging their contribution. Support would be in the form of an annual commitment to pay for the routine maintenance of the pathway, which in general costs about \$8,500 per mile. Parks & Recreation or other groups may administer this program.

Bicycle Events

Events are an excellent way to encourage increased bicycling. Events would need to be sponsored by local businesses, and involve some promotion, insurance, and development of adequate circuits for all levels of riders. It is not unusual for these events to draw up to 1,000 riders, which could bring some additional revenue into the area. The County can assist in developing these events by acting as a co-sponsor, and expediting and possibly underwriting some of the expense—for example—police time. The County should also encourage these events to have races and tours that appeal to the less experienced cyclist. For example, in exchange for local governments underwriting part of the costs of a race, the event promoters could hold a bicycle repair and maintenance workshop for kids, short fun races for kids, and/or a tour of the route lead by experienced cyclists who could show less experienced riders how to safely negotiate County streets.

Examples of possible events in Stanislaus County include:

- Bicycling booth at Stanislaus Jumping Frog Festival
- Sierra Century ride promotion
- Glory Hole Mountain Bike Race promotion
- Employer Incentives

Incentives to encourage employees to try bicycling to work include providing bicycle lockers and shower facilities, providing convenient and safe bicycle parking for employees and customers, and offering incentives to employees who commute by bicycle by allowing for more flexible arrival and departure times. The County may offer incentives to employers to institute these improvements through air quality credits, lowered parking requirements, reduced traffic mitigation fees, or other means.

Bike-to-Work and Bike-to-School Days

The County, possibly in conjunction with local cycling groups and with California Bike to Work Week, could help promote a local bike-to-work day. Bike-to-school days could be jointly sponsored with the School District, possibly in conjunction with bicycle education programs that are a part of Safe Routes to Schools.

Pedestrian Promotional Programs

Annual Events

Stanislaus County could produce an annual “Stanislaus Walks!” expo to promote the use of alternative modes of transportation, including shuttle services, buses, electric cars, bicycling, and carpooling. Other aspects of walking could also be showcased, including health benefits, the active lifestyle of those who walk, the equipment, the financial benefits, and the environmental benefits. The event could include:

- Exhibits from law enforcement
- Exhibits from vendors
- Exhibits from transit providers
- Exhibits from alternative modes of transportation providers
- Exhibits on pedestrian facilities
- Entertainment
- Sidewalk Stroll, a recreational walk for all ages

Monthly or Bimonthly Events

Sidewalk Strolls

Organized walks could be implemented for seniors at local centers. The goal of these events could be to generate interest in recreational walking for health reasons with the ultimate goal of promoting walking as a form of transportation.

Walking Tours

Organized walks could be organized for the general public in order to (1) showcase the destinations reachable by walking, (2) educate participants on walking as a mode of transportation and (3) promote walking as a healthy activity (4) experience the history of Stanislaus County in a unique way, especially the downtown areas.

Retail Involvement

Partnerships with local retailers could be established to promote walking. These partnerships could involve the campaign theme being promoted on bag stuffers and pre-printed bags. The costs of the bag stuffers and pre-printed bags could be born by retailers and could act as a donation by them. Stanislaus County could provide suggested artwork for the printed material. Retailers could, if possible, agree to provide counter space for guides and window space for promotional posters. This program could be implemented with an “adopt a sidewalk” program similar to the adoption of segments of the Interstate Highway system. Small signs located along the sidewalk could identify supporters, acknowledging their contribution. Support would be in the form of an annual commitment to pay for the routine maintenance of the sidewalk.

Employer Incentives

Employer incentives to encourage employees to try walking to work include sponsoring informational workplace events, providing incentives or vouchers for transit use and offering incentives to employees whose commute involves walking by allowing for more flexible arrival and departure times. The County may offer incentives to employers to institute these improvements through air quality credits, lowered parking requirements, reduced traffic mitigation fees, or other means.

Walk-to-Work and Walk-to-School Days

The County, possibly in conjunction with local volunteers could help promote a local walk-to-work day. Walk-to-school days could be jointly sponsored with the schools, possibly in conjunction with pedestrian education programs and Safe Routes to Schools activities.

This page intentionally left blank

7. Implementation

This chapter identifies steps towards implementation of the proposed facilities and programs of this plan, the estimated costs for the proposed improvements and maintenance, and strategies on funding and financing.

To support county-wide implementation, it is recommended that the Stanislaus Council of Governments establish a non-motorized transportation planner position. This position could oversee the development of bikeway and pedestrian facilities, funding coordination, and programs such as education and safe routes to school.

7.1. Implementation Process

The steps between the concepts identified in this Plan and final completion vary from project to project, but typically include:

- Adoption of this Plan by the Stanislaus Council of Governments.
- Completion of a project level Feasibility Study, which typically includes preliminary design, environmental analysis, alternatives analysis, related agency coordination, local staff, or by consultants. The final product should yield a preferred design alternative, environmental clearance, and an accurate cost estimate. At this stage any project involving a State Highway or Caltrans right-of-way should have appropriate encroachment permits and maintenance agreements in place, prior to funding, final design and construction.
- Approval of the preferred project by the local governing board, including acceptance of any environmental documentation. Local agency typically must commit to providing 10% of the project cost, and assume responsibility for the cost, operation, and liability for the project.
- Funding applied for and obtained for the project. Typically, all environmental work must be completed, local approval obtained, and the right-of-way in public control.
- Completion of final Plans, Specifications, and Estimates (P,S&E). Once completed, bids for construction services can be obtained.
- Construction of the project.

7.2. High Priority Projects

Once a bikeway system has been identified, the greatest challenge is to identify the top priority projects that will offer the greatest benefit to bicyclists if implemented. Prioritization involves a number of factors, including: (a) cost and construction feasibility given existing traffic, safety, and environmental constraints; (b) needs, benefit, and public support; (c) funding cycles and opportunities, and strength of the project as measured by specific funding criteria.

During the BPAC (Bicycle and Pedestrian Advisory Committee) Workshop #2, held in August 2008 to present the Draft Non-Motorized Transportation Plan, the BPAC members provided input on prioritizing the list of projects discussed in Chapter 5. Based on that input, those projects that were prioritized highest include those in the Countywide Primary Bikeway Network and are listed in **Table 7-1**.

Table 7-1: High Priority Projects

Segment Number	From	To	Bikeway Class	Length (Miles)
1	Patterson City Limits	Newman City Limits	Class I	10.33
2A	Crows Landing Rd.	W Bradbury Rd.	Class I	4.75
2A	W Bradbury Rd.	Crows Landing Rd.	Class I	0.74
2A	Turlock City Limits	Crows Landing Rd.	Class I	5.05
2B	SR 33	Prairie Flower Drain	Class II	5.37
3	TID Lateral No 4	Moore Rd.	Class I	5.76
4	Moore Rd.	Tully Rd.	Class I	3.80
5	Ceres Main	Turlock City Limits	Class I	3.82
6	S Santa Fe Ave.	Faith Home Rd.	Class I	1.99
7	E Hatch Rd.	Yosemite Blv.	Class I	2.40
8	Tuolumne River	S Santa Fe Ave.	Class I	2.95
8	Geer Rd.	MID Main	Class I	3.33
8	Tuolumne River	MID Lateral No 1	Class I	0.75
9	Dry Creek	Albers Rd.	Class I	4.77
9	Albers Rd.	Waterford City Limits	Class I	4.11
10	Riverbank City Limits	Albers Rd.	Class I	8.12
11	Riverbank City Limits	Oakdale City Limits	Class I	2.40
12	Claus Rd.	Oakdale City Limits	Class II	2.60
13	Oakdale City Limits	Waterford City Limits	Class III	7.33
14B	Turlock City Limits	S Santa Fe Ave.	Class II	2.66
14A	Turlock City Limits	Oakdale City Limits	Class III	14.08
15	Claus Rd.	N Eucalyptus Ave.	Class III	7.79
16A	E Service Rd.	Crows Landing Rd.	Class II	0.51
16A	E Whitmore Ave.	E Service Rd.	Class II	1.00
16A	Ceres City Limits	E Grayson Rd.	Class II	0.49
16A	SR 33	W Grayson Rd.	Class III	13.95
17	San Joaquin River	Turlock City Limits	Class III	9.90
17	Sycamore Ave.	San Joaquin River	Class III	2.01
18	Modesto City Limits	Bridgewood Wy.	Class II	0.56
18	Claribel Rd.	Modesto City Limits	Class II	0.75
18	Crawford Rd.	Claribel Rd.	Class II	0.49

It is important to remember that the lists of bikeway projects and programs are flexible concepts that serve as guidelines to those responsible for implementation. The High Priority project list, and perhaps even the overall system and segments themselves may change over time as a result of changing bicycling patterns and implementation constraints and opportunities. The Stanislaus Council of Governments, staff, and BPAC should review the High Priority project list on an annual basis to ensure that it reflects the most current priorities, needs, and opportunities for implementing the bikeway network in a logical and efficient manner, and that in particular the list takes advantage of all available funding opportunities and grant cycles. As projects are implemented and taken off the list, new projects should be moved up into High Priority status.

7.3. Cost Estimates

The costs for developing bicycle facilities provided in this report were developed using unit costs outlined in **Table 7-2**.

Table 7-2: Estimated Bicycle Facility Basic Unit Costs

Facility	Total per mile cost
Class I	\$833,425
Class II	\$28,200
Class III	\$12,600
BB w/traffic calming	\$388,125
Sharrows	\$17,500
Class II with widening, minor	\$225,163
Class II with widening, major	\$239,825
RR Imp Minor	\$105,981
RR Imp Major	\$163,178

The costs for developing pedestrian facilities provided in this report were developed using **Table 7-3**.

Table 7-3: Estimated Pedestrian Improvement Basic Unit Costs

Item	Unit	Unit Cost
Add Striping	LF	\$2
Bench	EA	\$2,000
Concrete Planter Bollards	EA	\$200
Bus Stop (Shelter, Bench, Curb Cut, Bus Pad)	EA	Starting at \$40,000
Class I Path Construction	LF	\$100
Concrete Sidewalk/Island	SF	\$9
Countdown Signal Heads	EA	\$800
Crosswalk - High Visibility	EA	\$1,200
Crosswalk - In Pavement Flashing Lights	EA	\$75,000
Crosswalk - Transverse	EA	\$500
Curb & Gutter	LF	\$35
Curb Extension - First installment at intersection	EA	\$100,000
Curb Extension - Additional installments at intersection	EA	\$50,000
Curb Ramp Retrofit (diagonal, per corner)	EA	\$2,000
Curb Ramp Retrofit (Perpendicular, per corner)	EA	\$5,000
Median Nose Reduction	EA	\$2,000
Mid-block crossing barrier	LF	\$30
Move Traffic Signal	EA	\$200,000
Parking Restrictions -- Red Curb	EA	\$20
Ped Push Button	EA	\$800
Pedestrian Median Refuge Island	EA	\$30,000
Pedestrian Scramble	EA	\$50,000
Pedestrian-scale Lighting	LF	\$250
Reduce Curb Radii – First installment	EA	\$80,000
Reduce Curb Radii – Additional installments	EA	\$30,000

Item	Unit	Unit Cost
Remove Curb	LF	\$4
Remove Striping	LF	\$1
Resurface Sidewalk - 5' Wide	LF	\$40
Sidewalk - 10' Wide	LF	\$90
Sidewalk - 5' Wide	LF	\$45
Sidewalk Widening	LF	\$46
Signs, In-Pavement Yield Paddles	EA	\$200
Signs, Overhead Beacon	EA	\$50,000
Signs, Speed Feedback	EA	\$10,000
Signs, Warning	EA	\$200
Stop Limit Bars/ Yield Teeth	EA	\$300
Trash Receptacle	EA	\$1,200
Trees	EA	\$800
Truncated Domes (retrofit plastic)	EA	\$800

Table 7-4 summarizes previously outlined recommended bicycle and pedestrian facility improvement costs, organized by jurisdiction and type of improvement.

Table 7-4: Facility Cost Estimates by Jurisdiction

Jurisdiction	Bikeways	Pedestrian	Total
County	\$138,820,400	\$0	\$138,820,400
Ceres	\$5,473,400	\$345,200	\$5,818,600
Modesto	\$50,832,600	\$47,200	\$50,879,800
Hughson	\$151,600	\$0	\$151,600
Newman	\$3,403,400	\$121,375	\$3,524,775
Oakdale	\$10,729,900	\$356,200	\$11,086,100
Patterson	\$2,395,800	\$286,000	\$2,681,800
Riverbank	\$8,529,000	\$244,900	\$8,773,900
Turlock	\$10,683,500	\$400,300	\$11,083,800
Waterford	\$4,372,800	\$342,725	\$4,715,525
Total	\$235,392,400	\$2,143,900	\$237,536,300

7.4. Funding Resources

Federal Funding Sources

The primary federal source of surface transportation funding—including bicycle and pedestrian facilities—is SAFETEA-LU, the Safe, Accountable, Flexible, Efficient Transportation Equity Act: A Legacy for Users. SAFETEA-LU is the fourth iteration of the transportation vision established by Congress in 1991 with the Intermodal Surface Transportation Efficiency Act (ISTEA) and renewed in 1998 and 2003 through the Transportation Equity Act for the 21st Century (TEA-21) and the Safe, Accountable, Flexible, and Efficient Transportation Equity Act of 2003 (SAFETEA). Also known as the federal transportation bill, the \$286.5 billion SAFETEA-LU bill was passed in 2005 and authorizes Federal surface transportation programs for the five-year period between 2005 and 2009.

SAFETEA-LU funding is administered through the State (Caltrans and the State Resources Agency) and regional planning agencies. Most, but not all, of these funding programs are oriented toward transportation versus recreation, with an emphasis on reducing auto trips and providing inter-modal connections. SAFETEA-LU programs require a local match of 11.47%. SAFETEA-LU funding is intended for capital improvements and safety and education programs and projects must relate to the surface transportation system.

Specific funding programs under SAFETEA-LU include:

- **Congestion Mitigation and Air Quality (CMAQ)** – Funds projects that are likely to contribute to the attainment of national ambient air quality standards
- **Recreational Trails Program**—\$370 million nationally through 2009 for Non-Motorized trail projects
- **Safe Routes to School Program**—\$612 million nationally through 2009
- **Transportation, Community and System Preservation Program**—\$270 million nationally over five years
- **Federal Lands Highway Funds**—Approximately \$1 billion dollars are available nationally through 2009

Federal Lands Highway Funds

Federal Lands Highway Funds may be used to build bicycle and pedestrian facilities in conjunction with roads and parkways at the discretion of the department charged with administration of the funds. The projects must be transportation-related and tied to a plan adopted by the State and MPO. Federal Lands Highway Funds may be used for planning and construction.

Transportation, Community and System Preservation Program

The Transportation, Community and System Preservation (TCSP) Program provides federal funding for transit oriented development, traffic calming and other projects that improve the efficiency of the transportation system, reduce the impact on the environment, and provide efficient access to jobs, services and trade centers. The program is intended to provide communities with the resources to explore the integration of their transportation system with community preservation and environmental activities. TCSP Program funds require a 20% match.

Regional Surface Transportation Program

The Regional Surface Transportation Program (RSTP) is a block grant program which provides funding for bicycle and pedestrian projects, among many other transportation projects. Under the RSTP, Metropolitan Planning Organizations, such as StanCOG, prioritize and approve projects which will receive RSTP funds. TAMC distributes the RSTP funds to local jurisdictions. Metropolitan planning organizations can transfer funding from other federal transportation sources to the RSTP program in order to gain more flexibility in the way the monies are allocated. In California, 62.5% of RSTP funds are allocated according to population. The remaining 37.5% is available statewide.

Regional Transportation Improvement Program

The Regional Transportation Improvement Program (RTIP) is a derivative of the STIP program and identifies projects which are needed to improve regional transportation. Such projects may include bicycle and pedestrian facilities, safety projects and grade separation, among many others. RTIP project planning, programming and monitoring may be funded up to .5% of total RTIP funds in urbanized regions and 2% of total RTIP funds in non-

FUNDING GLOSSARY
CTC <i>California Transportation Commission</i>
FHWA <i>Federal Highway Administration</i>
MPO <i>Metropolitan Planning Organization</i>
RTIP <i>Regional Transportation Improvement Program</i>
RTP <i>Regional Transportation Plan</i>
RTPA <i>Regional Transportation Planning Agency</i>
SAFETEA-LU <i>Safe, Accountable, Flexible, Efficient Transportation Equity Act: A Legacy for Users</i>
STIP <i>State Transportation Improvement Program</i>

urbanized regions. Each RTPA prepares a RTIP, consisting of projects to be funded through STIP. The RTPA's Regional Transportation Plan helps prioritize projects for the RTIP. RTIPs must be approved by the CTC. Projects to be funded by RTIP funds must be identified in the current or next Regional Transportation Plan.

Recreational Trails Program

The Recreational Trails Program of SAFETEA-LU provides funds to states to develop and maintain recreational trails and trail-related facilities for both Non-Motorized and motorized recreational trail uses. Examples of trail uses include hiking, bicycling, in-line skating, equestrian use, and other Non-Motorized as well as motorized uses. In California, the funds are administered by the California Department of Parks and Recreation. RTP projects must be ADA compliant. Recreational Trails Program funds may be used for:

- Maintenance and restoration of existing trails;
- Purchase and lease of trail construction and maintenance equipment;
- Construction of new trails; including unpaved trails;
- Acquisition of easements or property for trails;
- State administrative costs related to this program (limited to 7% of a State's funds); and
- Operation of educational programs to promote safety and environmental protection related to trails (limited to 5% of a State's funds).

Land and Water Conservation Fund

Land and Water Conservation Fund is a federally funded program that provides grants for planning and acquiring outdoor recreation areas and facilities, including trails. The Fund is administered by the National Parks Service and the California Department of Parks and Recreation and has been reauthorized until 2015.

Cities, counties and districts authorized to acquire, develop, operate and maintain park and recreation facilities are eligible to apply. Applicants must fund the entire project, and will be reimbursed for 50% of costs. Property acquired or developed under the program must be retained in perpetuity for public recreational use. The grant process for local agencies is competitive, and 40% of grants are reserved for Northern California.

In 2007, approximately \$1.27 million was available for projects in California.

Rivers, Trails and Conservation Assistance Program

The Rivers, Trails and Conservation Assistance Program (RTCA) is a National Parks Service program which provides technical assistance via direct staff involvement, to establish and restore greenways, rivers, trails, watersheds and open space. The RTCA program provides only for planning assistance—there are no implementation monies available. Projects are prioritized for assistance based upon criteria which include conserving significant community resources, fostering cooperation between agencies, serving a large number of users, encouraging public involvement in planning and implementation and focusing on lasting accomplishments.

Statewide Funding Sources

The State of California uses both federal sources and its own budget to fund the following bicycle and pedestrian projects and programs.

Bicycle Transportation Account

The Bicycle Transportation Account (BTA) provides state funding for local projects that improve the safety and convenience of bicycling for transportation. Because of its focus on transportation, BTA projects, including trail, must provide a transportation link. Funds are available for both planning and construction. BTA funding is administered by Caltrans and cities and counties must have an adopted Bicycle Transportation Plan in order to be eligible. Bicycle Transportation Plans must be approved by the local MPO prior to Caltrans approval. Out of \$5 million available statewide, the maximum amount available for individual projects is \$1.2 million.

Wildlife Conservation Board Public Access Program

Funding for the acquisition of lands or improvements that preserve wildlife habitat or provide recreational access for hunting, fishing or other wildlife-oriented activities. Up to \$250,000 dollars available per project, applications accepted quarterly. Projects eligible for funding include interpretive trails, river access, and trailhead parking areas. The State of California must have a proprietary interest in the project. Local agencies are generally responsible for the planning and engineering phases of each project.

California Conservation Corps

The California Conservation Corps (CCC) is a public service program which occasionally provides assistance on construction projects. The CCC may be written into grant applications as a project partner. In order to utilize CCC labor, project sites must be public land or be publicly accessible. CCC labor cannot be used to perform regular maintenance, however, they will perform annual maintenance, such as the opening of trails in the spring.

Safe Routes to School (SR2S)

Caltrans administers funding for Safe Routes to School projects through two separate and distinct programs: the state-legislated Program (SR2S) and the federally-legislated Program (SRTS). Both programs competitively award reimbursement grants with the goal of increasing the number of children who walk or bicycle to school. The programs differ in some important respects.

California Safe Routes to School Program expires January 1, 2013, requires a 10% local match, is eligible to cities and counties and targets children in grades K-12. The fund is primarily for construction, but up to 10% of the program funds can be used for education, encouragement, enforcement and evaluation activities. Fifty-two million dollars are available for Cycle 7 (FY 06/07 and 07/08).

The Federal Safe Routes to School Program expires September 30, 2009, reimburses 100%, is eligible for cities, counties, school districts, non-profits, and tribal organizations, and targets children in grades K-8. Program funds can be used for construction or for education, encouragement, enforcement and evaluation activities. Construction must be within 2 miles of a grade school or middle school. Forty-six million dollars are available for Cycle 2 (FY 08/09 and 09/10).

Environmental Justice: Context Sensitive Planning Grants

The Caltrans-administered Environmental Justice: Context Sensitive Planning Grants promotes context sensitive planning in diverse communities and funds planning activities that assist low-income, minority and Native American communities to become active participants in transportation planning and project development. Grants are available to transit districts, cities, counties and tribal governments. This grant is funded by the State Highway Account at \$1.5 million annually state-wide. Grants are capped at \$250,000.

Office of Traffic Safety (OTS) Grants

The California Office of Traffic Safety distributes federal funding apportioned to California under the National Highway Safety Act and SAFETEA-LU. Grants are used to establish new traffic safety programs, expand ongoing programs or address deficiencies in current programs. Bicycle and pedestrian safety are included in the list of traffic safety priority areas. Eligible grantees are: governmental agencies, state colleges, and state universities, local Town and County government agencies, school districts, fire departments and public emergency services providers. Grant funding cannot replace existing program expenditures, nor can traffic safety funds be used for program maintenance, research, rehabilitation or construction. Grants are awarded on a competitive basis, and priority is given to agencies with the greatest need. Evaluation criteria to assess need include: potential traffic safety impact, collision statistics and rankings, seriousness of problems, and performance on previous OTS grants. OTS expects to have \$56 million in funding available statewide for FY 2006/07.

Community Based Transportation Planning Demonstration Grant Program

This fund, administered by Caltrans, provides funding for projects that exemplify livable community concepts including bicycle and pedestrian improvement projects. Eligible applicants include local governments, MPO's and RPTA's. A 20% local match is required and projects must demonstrate a transportation component or objective. There are \$3 million dollars available annually statewide.

Local Funding Sources

TDA Article 3

Transportation Development Act (TDA) Article 3 funds are state block grants awarded annually to local jurisdictions for transit, bicycle and pedestrian projects in California. Funds for pedestrian projects originate from the Local Transportation Fund (LTF), which is derived from a ¼ cent of the general state sales tax. LTF funds are returned to each county based on sales tax revenues. Eligible pedestrian and bicycle projects include: construction and engineering for capital projects; maintenance of bikeways; bicycle safety education programs (up to 5% of funds); and development of comprehensive bicycle or pedestrian facilities plans. A Town or county is allowed to apply for funding for bicycle or pedestrian plans not more than once every five years. These funds may be used to meet local match requirements for federal funding sources. 2% of the total TDA apportionment is available for bicycle and pedestrian funding.

Non-Traditional Funding Sources

American Greenways Program

Administered by The Conservation Fund, the American Greenways Program provides funding for the planning and design of greenways. Applications for funds can be made by local regional or state-wide non-profit organizations and public agencies. The maximum award is \$2,500, but most range from \$500 to \$1,500. American Greenways Program monies may be used to fund unpaved trail development.

California Center for Physical Activity Grant Program

The California Center for Physical Activity runs several programs related to walking and offers small grants to public health departments. Grants are in the amount of \$4,999 dollars or less and are offered intermittently.

Requirements for New Developments

With the increasing support for “routine accommodation” and “complete streets,” requirements for new development, road widening and new commercial development provide opportunities to efficiently construct pedestrian facilities.

Impact Fees

One potential local source of funding is developer impact fees, typically tied to trip generation rates and traffic impacts produced by a proposed project. A developer may attempt to reduce the number of trips (and hence impacts and cost) by paying for on- and off-site pedestrian improvements designed to encourage residents, employees and visitors to the new development to walk rather than drive. Establishing a clear nexus or connection between the impact fee and the project's impacts is critical to ensure legal soundness.

Mello-Roos Community Facilities Act

The Mello-Roos Community Facilities Act was passed by the Legislature in 1982 in response to reduced funding opportunities brought about by the passage of Proposition 13. The Mello-Roos Act allows any county, Town, special district, school district or joint powers of authority to establish a Community Facility Districts (CFD) for the purpose of selling tax-exempt bonds to fund public improvements within that district. CFDs must be approved by a two-thirds margin of qualified voters in the district. Property owners within the district are responsible for paying back the bonds. Pedestrian facilities are eligible for funding under CFD bonds.

Volunteer and Public-Private Partnerships

Volunteer programs may substantially reduce the cost of implementing some of the proposed pathways. Use of groups such as the California Conservation Corp (who offers low cost assistance) will be effective at reducing project costs. Local schools or community groups may use the bikeway or pedestrian project as a project for the year, possibly working with a local designer or engineer. Work parties may be formed to help clear the right of way where needed. A local construction company may donate or discount services. A challenge grant program with local businesses may be a good source of local funding, where corporations 'adopt' a bikeway and help construct and maintain the facility.

Other opportunities for implementation will appear over time that may be used to implement the system.

This page intentionally left blank

Appendix A: Bikeway Design Guidelines

This appendix provides basic bikeway planning and design guidelines for use in developing the Stanislaus bikeway system and support facilities. All recommendations in this appendix fall into one of three categories:

- “Design Requirements” for Class I, II and III facilities contain elements required by the State of California for compliance with Caltrans Chapter 1000 “Bikeway Planning and Design” guidelines.
- “Additional Design Recommendations” provide information on optional design treatments. Although this information meets Caltrans requirements it is not intended to state a minimum or maximum accommodation or to replace any existing adopted roadway design guidelines.
- “Experimental or Nonstandard Best Practices” provides information about optional innovative bikeways and support facilities that have not been adopted for use in California and do not meet Caltrans Chapter 1000 design requirements.

All facility designs are subject to engineering design review.

Bikeway Facility Classifications

According to Caltrans, the term “bikeway” encompasses all facilities that provide primarily for bicycle travel. Caltrans has defined three types of bikeways in Chapter 1000 of the Highway Design Manual: Class I, Class II, and Class III. For each type of bikeway facility both “Design Requirements” and “Additional Design Recommendations” are provided. “Design Requirements” contain requirements established by Caltrans Chapter 1000 “Bikeway Planning and Design”. “Additional Design Recommendations” are provided as guidelines to assist with design and implementation of facilities and include alternate treatments approved or recommended by not required by Caltrans.

Figure A-1 provides an illustration of these three types of bicycle facilities.

Class I Bikeway - Design Requirements

Typically called a “bike path” or “shared use path,” a Class I bikeway provides bicycle travel on a paved right-of-way completely separated from any street or highway. The recommended width of a shared use path is dependent upon anticipated usage:

8’ (2.4 m) is the minimum width for Class I facilities

8’ (2.4 m) may be used for short neighborhood connector paths (generally less than one mile in length) due to low anticipated volumes of use

10’ (3.0 m) is the recommended minimum width for a typical two-way bicycle path

12’ (3.6 m) is the preferred minimum width if more than 300 users per peak hour are anticipated, and/or if there is heavy mixed bicycle and pedestrian use

A minimum 2’ (0.6 m) wide graded area must be provided adjacent to the path to provide clearance from trees, poles, walls, guardrails, etc. On facilities with expected heavy use, a yellow centerline stripe is recommended to separate travel in opposite directions. **Figure A-2** illustrates a typical cross-section of a Class I multi-use path.

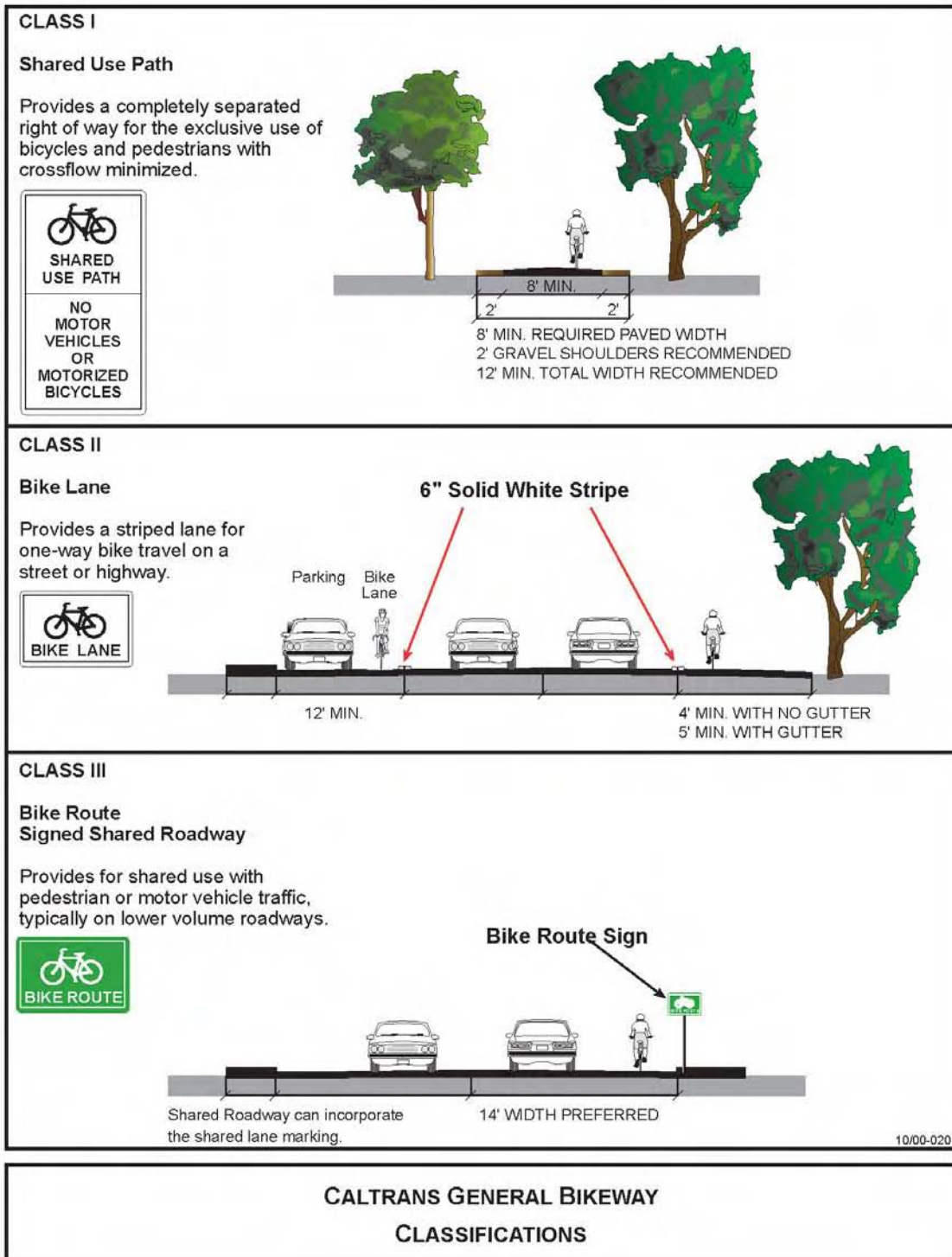
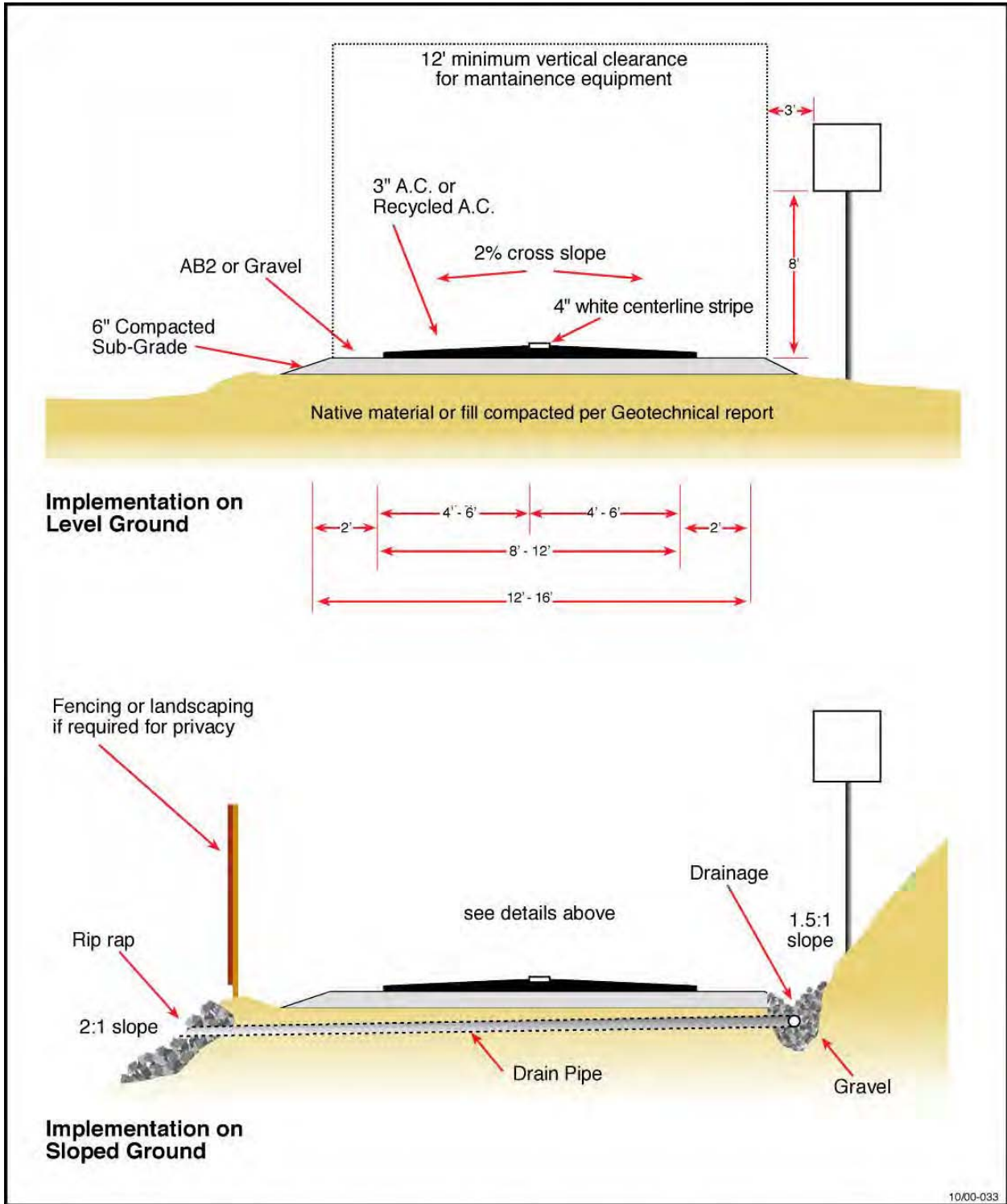

Figure A-1: Bicycle Facility Types



**BIKE PATH OR MULTI-USE TRAIL
CROSS SECTION**

alta
TRANSPORTATION CONSULTING

Figure A-2: Class I Facility Cross-Section

Class I Bikeway - Additional Design Recommendations:

Shared use trails and unpaved facilities that serve primarily a recreation rather than a transportation function and will not be funded with federal transportation dollars may not be required to be designed to Caltrans standards. However, state and national guidelines have been created with user safety in mind and should be followed. Wherever any trail facility intersects with a street, roadway, or railway, standard traffic controls should always be used.

1. Class I bike path crossings of roadways require preliminary design review. Generally speaking, bike paths that cross roadways with average daily trips (ADTs) over 20,000 vehicles will require signalization or grade separation.
2. Landscaping should generally be low water consuming native vegetation and should have the least amount of debris.
3. Lighting should be provided where commuters will use the bike path during hours of darkness.
4. Barriers at pathway entrances should be clearly marked with reflectors and be ADA accessible (minimum five feet clearance).
5. Bike path construction should take into account impacts of maintenance and emergency vehicles on shoulders and vertical and structural requirements. Paths should be constructed with adequate sub grade compaction to minimize cracking and sinking.
6. All structures should be designed to accommodate appropriate loadings. The width of structures should be the same as the approaching trail width, plus minimum two-foot wide clear areas.
7. Where feasible, provide two-foot wide unpaved shoulders for pedestrians/runners, or a separate tread way.
8. Direct pedestrians to the right side of pathway with signing and/or stenciling.
9. Consider using bicycle signal heads at locations where sidepaths meet signalized intersections.

One-way Bike Paths (Cycle Tracks)

The treatment provides a physical barrier between bikes and cars. It is useful along streets with minimal crossings. Installation of a one-way bike path should be undertaken only after careful consideration due to the problems of enforcing one-way operation, the difficulties in maintaining a path of restricted width and the potential for increased motor vehicle-bicycle conflicts at driveways, side streets and intersections.

Potential applications include:

- When adequate pedestrian facilities exist so that the bike facility will not be considered a "multi-use path"
- Relatively few driveways or intersections
- Provides connection between two shared use path facilities
- Intersection transitions can be made
- Moderate to high speeds
- Regular street sweeping of track is possible
- There is an equivalent bikeway for the opposite direction that will be more attractive for cyclists in lieu of riding the wrong way on the track

- Where path does not interfere with transit stops

Breaks may be provided in advance of cross streets or major destinations. On some routes, it may be appropriate to use soft hit posts or other means of physical separation 40 inches in height. However, Caltrans Chapter 1000 prohibits use of raised pavement markers to delineate bike lanes. There must be an equivalent bikeway for the opposite direction of travel that will be more attractive to bicyclists than riding the wrong way in the one-direction cycle track. To minimize conflicts between cyclists and motorists it may be advisable to use bicycle signal heads at signalized intersections.

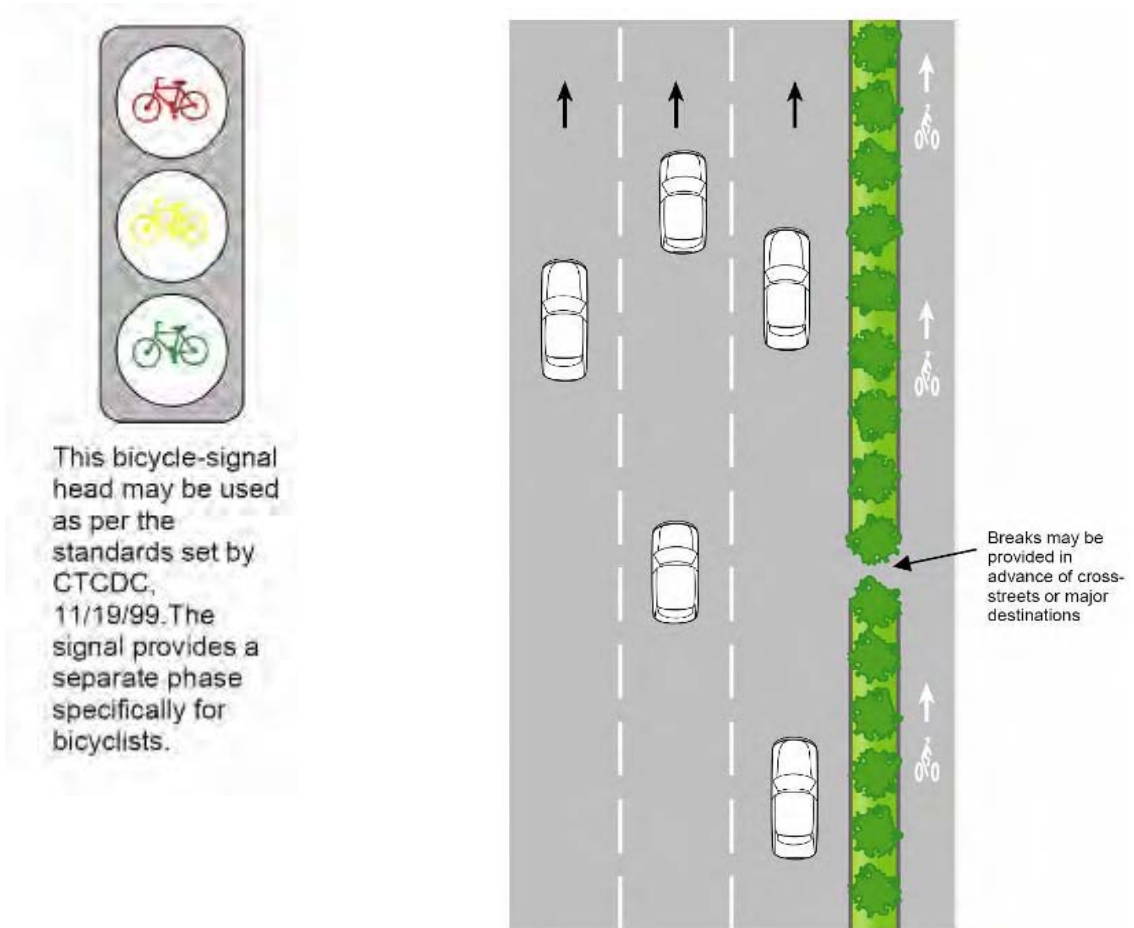

Figure A-3: One-way Bike Path (Cycle Track) and Bicycle Signal Head

Class II Bikeway - Design Requirements

Often referred to as a “bike lane,” a Class II bikeway provides a striped and stenciled lane for one-way travel on either side of a street or highway. **Figure A-4** shows a typical Class II cross-section. To provide bike lanes along corridors where insufficient space is currently available, extra room can be provided by removing a traffic lane, narrowing traffic lanes, or prohibiting parking. The width of the bike lanes vary according to parking and street conditions. Note that these dimensions are for reference only, may not meet Stanislaus Standards and are subject to engineering design review.

4' (1.2 m) minimum if no gutter exists, measured from edge of pavement

5' (1.5 m) minimum with normal gutter, measured from curb face; or 3' (0.9 m) measured from the gutter pan seam

5' (1.5 m) minimum when parking stalls are marked

11' (3.3 m) minimum for a shared bike/parking lane where parking is permitted but not marked on streets without curbs; or 12' (3.6 m) for a shared lane adjacent to a curb face.

Class II Bikeway - Additional Design Recommendations:

1. The County should recommend that wider bike lanes beyond the minimum standard be installed.
2. Intersection and interchange treatment – Caltrans provides recommended intersection treatments in Chapter 1000 including bike lane “pockets” and signal loop detectors. The County should develop a protocol for the application of these recommendations, so that improvements can be funded and made as part of regular improvement projects.
3. Signal loop detectors, which sense bicycles, should be considered for all arterial/arterial, arterial/collector, and collector/collector intersections. A stencil of a bicycle and the words “Bicycle Loop” should identify the location of the detectors.
4. When loop detectors are installed, traffic signalization should be set to accommodate bicycle speeds.
5. Bicycle-sensitive loop detectors are preferred over a signalized button specifically designed for bicyclists (see discussion of loop detectors, below).
6. Bike lane pockets (min. 4' wide) between right turn lanes and through lanes should be provided wherever available width allows, and right turn volumes exceed 150 motor vehicles/hour.
7. Where bottlenecks preclude continuous bike lanes, they should be linked with Class III route treatments.
8. A bike lane should be delineated from motor vehicle travel lanes with a solid 6" white line, per MUTCD. An 8" line width may be used for added distinction.
9. Word and symbol pavement stencils should be used to identify bicycle lanes, as per Caltrans and MUTCD specifications.
10. Narrowing automobile travel lane widths.
11. Bicycle signal heads may be used at locations with extremely high motorist-cyclist conflicts.

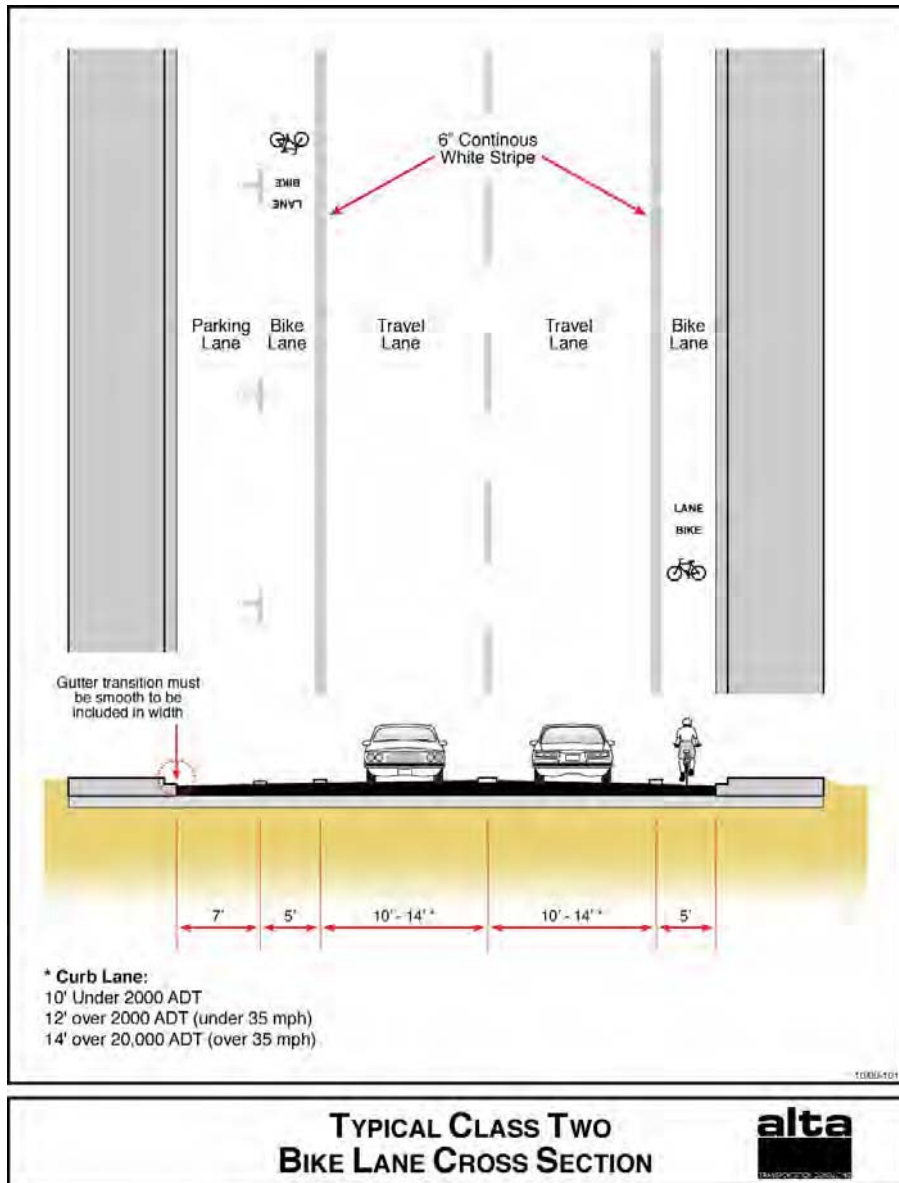

Figure A-4: Typical Class II Facility Cross-Section

Installing bike lanes may require more attention to continuous maintenance issues. Bike lanes tend to collect debris as vehicles disperse gravel, trash, and glass fragments from traffic lanes to the edges of the roadway. Striping and stenciling will need periodic replacing.

Poorly designed or placed drainage grates can often be hazardous to bicyclists. Drainage grates with large slits can catch bicycle tires. Poorly placed drainage grates may also be hazardous, and can cause bicyclists to veer into the auto travel lane. **Figure A-5** illustrates bicycle friendly drainage grates.

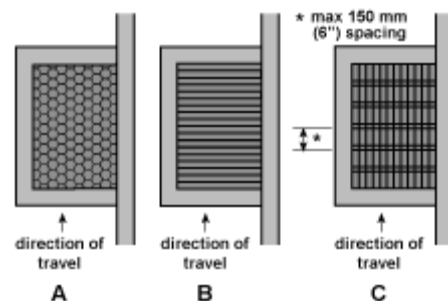

Figure A-5: Examples of bicycle friendly drainage grates

Class II Bikeway - Experimental or Nonstandard Best Practices

The following section provides information about optional innovative designs for bicycle lanes that have not been adopted for use in California and do not meet Caltrans Chapter 1000 design requirements.

Colored Bicycle Lanes

Colored bike lanes could be used in high-conflict areas, to alert drivers of the presence of bicyclists and bicycle lanes. These areas can be painted or treated with a thermoplastic. Typically, yield signs that instruct bicyclists and drivers about the lanes are installed wherever the colored lane treatments are used. **Figure A-6** illustrates a colored bicycle lane treatment.

Potential applications include:

- High volume of vehicles turning across bike lane to exit or enter a roadway in a ramp-like configuration. This should not be used in typical 4-legged intersection situations that simply have a high volume of turning motor vehicles
- Roadways / ramps merge at angles where motorist sight distance is impaired, or that cause motorists to be looking to merge in such a way that they may not see cyclists in a normally marked bike lane
- High volume of bicyclists
- Cyclists have priority movement

Other potential situations for application of colored bike lanes include:

- Contra-flow bike lanes
- Left-side bike lanes on high volume roads
- Bike-only left-turn pockets

National committees are currently reviewing the use of color for bike lane situations. Should they make a recommendation for green or other colors, the design would use the recommended coloring. Use of this type of lane may also require changes to the California Vehicle Code. The City of Portland conducted a study of colored bike lanes through conflict zone, demonstrating that motorists yield to bicyclists 92% of the time (compared to 72% of the time before colored bike lane implementation). Fewer bicyclists approaching the conflict area looked for oncoming traffic after the blue pavement was put in place. Colored bicycle lanes have also been used in Cambridge, MA, New York City, Montreal, Denmark, the Netherlands and other European countries.

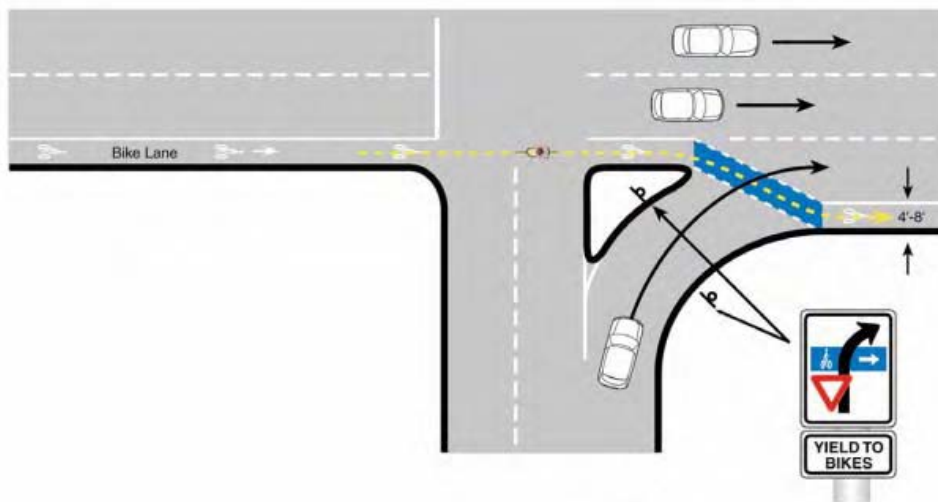

Figure A-6: Colored Bicycle Lane Through Conflict Zone

Contraflow Bicycle Lanes

A contra-flow bicycle lane (**Figure A-7**) provides a striped lane going against the flow of automobile travel. The lanes should be separated by a double-yellow line. This type of treatment should only be considered after all other methods to accommodate bicycles along a corridor have been considered. This treatment is to be considered the exception, and not the rule, for one-way streets. As a part of trial implementation, an effective sign design to accompany this treatment needs to be determined. A standard two way traffic warning sign (W44) may be most appropriate.

Potential applications include:

- Provides direct access to key destination
- Improves safety
- Infrequent driveways on bike lane side
- Bicyclists can safely and conveniently re-enter traffic at either end
- Sufficient width to provide bike lane
- No parking on side of street with bike lane
- Existing high bicycle usage of street
- Less than three blocks in length
- No other reasonable route for bicyclist

Contraflow bicycle lanes have been used in Portland, OR, Madison, WI, San Francisco, CA and Cambridge, MA.

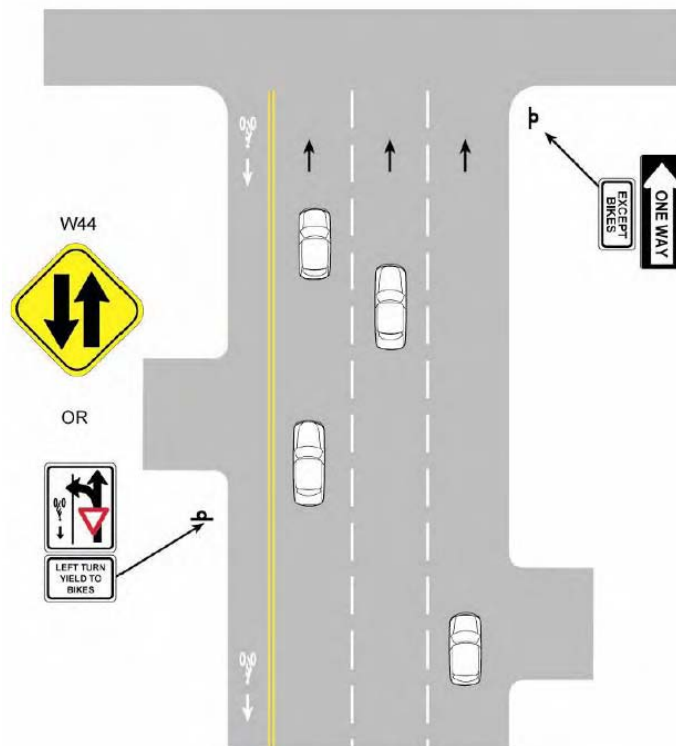

Figure A-7: Contraflow Bicycle Lane

Floating Bicycle Lanes

This treatment (**Figures A-8**) designates a single lane to function as a parking lane, a designated bike route, and then both, depending on the time of day. During peak commute times when parking is not allowed, cyclists will use the shoulder. During off-peak hours when parking is allowed, bicyclists can use the space between the remaining automobile travel lanes and the parking lane. Beginning of each block must be cross hatched appropriately to prohibit parking in this location. Various treatments can be implemented as necessary, such as: cross hatching at beginning of facility, wider lane lines, merge signs, and longer parking T's to discourage use of lane by motor vehicles during off-peak hours. This treatment is used on The Embarcadero in San Francisco.

Potential applications include:

- Primary bicycle commute routes
- Not enough width to provide standard bike lane and parking

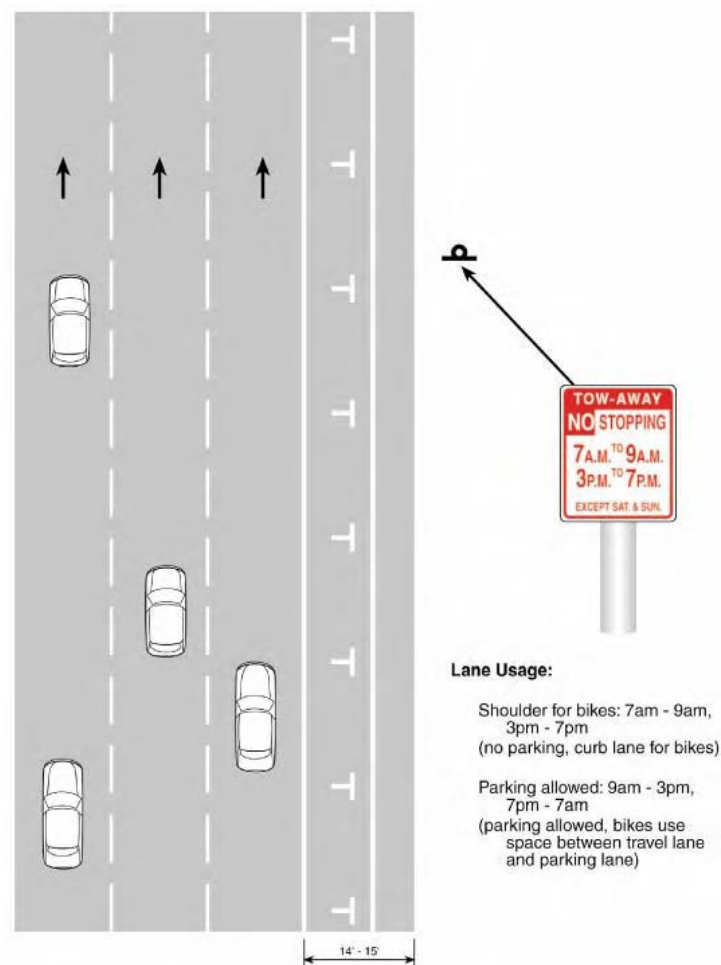

Figure A-8: Floating Bicycle Lane

Bicycle Boxes

This treatment includes a bicycle lane leading to a “box” situated behind the crosswalk and in front of the motor vehicle stop bar. The bike box (**Figure A-9**) allows bicyclists to move to the front of the queue and position themselves for turning movements. The treatment is also intended to improve the visibility of bicyclists. A bicycle marking is stenciled in the box and should be accompanied by signs communicating where bicycles and motor vehicles should stop.

Potential applications include:

- At intersections with a high volume of bicycles and motor vehicles
- Where there are frequent turning conflicts and/or intersections with a high percentage of turning movements by both bicyclists and motorists
- No right turn on red
- Can be combined with a bicycle signal (optional)

In the US, bicycle boxes have been used in Cambridge, MA, Portland, OR and Eugene, OR. They have been used in a variety of locations throughout Europe.

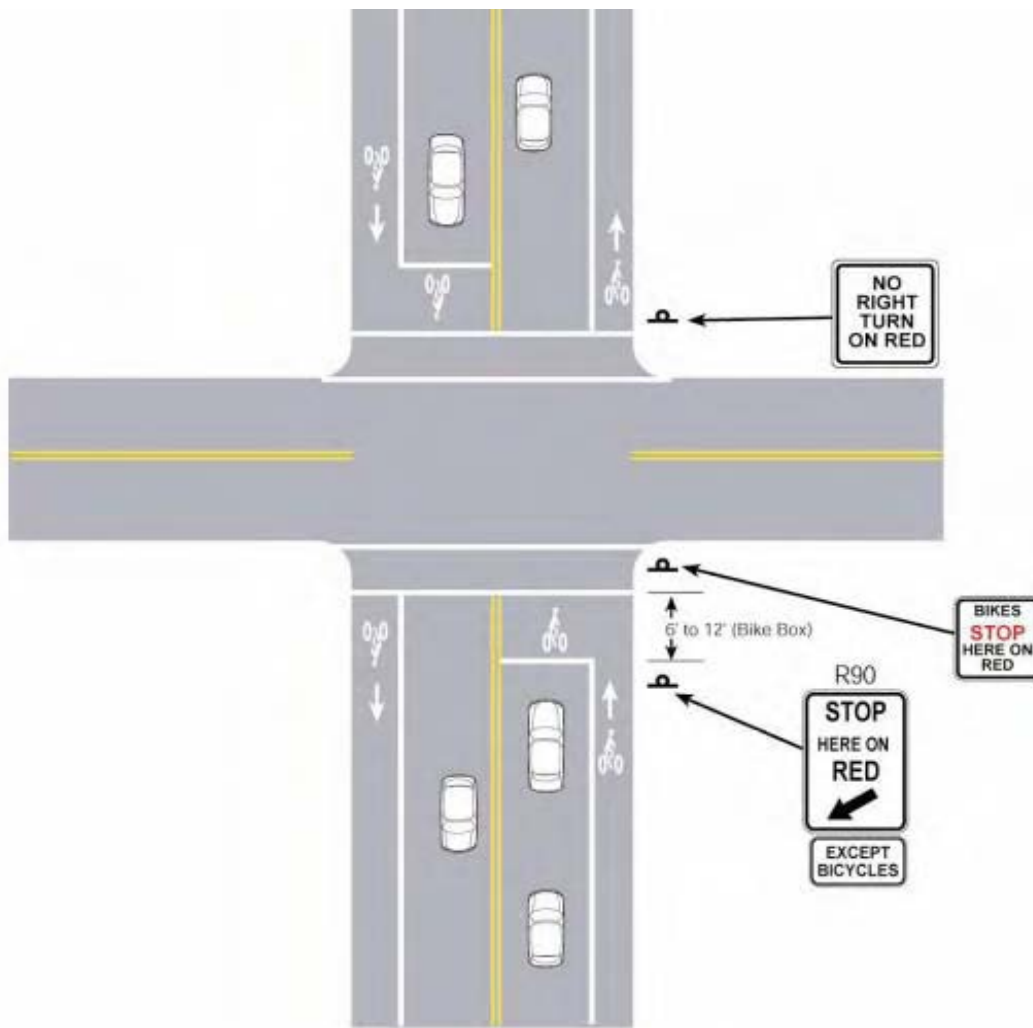

Figure A-9: Bicycle Box

Bicycle Left-turn Pocket Lane

This treatment shows a standard-width bicycle lane adjacent to the left-hand turn lane in order to reduce conflicts with turning vehicles (**Figure A-10**). The Bicyclists Merging sign may be placed on the right side of the road before the left-side turn pocket. This treatment has been used in San Francisco, CA and Flagstaff, AZ.

Potential applications include:

- Low-moderate speeds
- On lower volume arterials and collectors
- Heavy vehicular left-hand turning movements

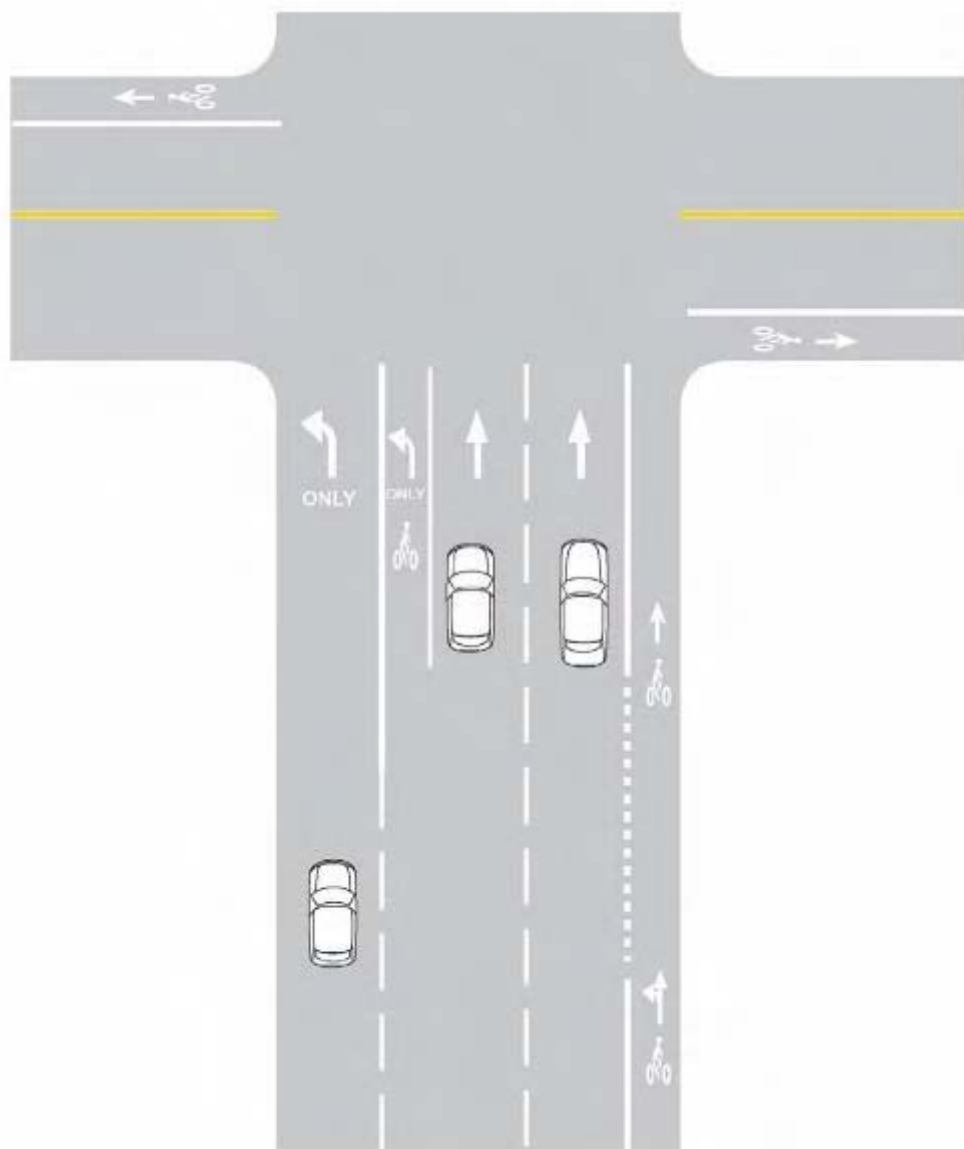

Figure A-10: Bicycle Left-turn Pocket Lane

Class III Bikeway - Design Requirements

Generally referred to as a “bike route,” a Class III bikeway provides routes through areas not served by Class I or II facilities or to connect discontinuous segments of a bikeway.

Class III facilities can be shared with either motorists on roadways or pedestrians on a sidewalk (not advisable) and is identified only by signing. There are no recommended minimum widths for Class III facilities, but when encouraging bicyclists to travel along selected routes, traffic speed and volume, parking, traffic control devices, and surface quality should be acceptable for bicycle travel. Although it is not a requirement, a wide outside traffic lane (14') is typically preferable to enable cars to safely pass bicyclists without crossing the centerline. Caltrans Chapter 1000 provides details regarding the design requirements for placement and spacing of bicycle route signage.

Class III Bikeway - Additional Design Recommendations

Shared Roadway Bicycle Marking

Recently, Shared Lane Marking stencils (also called “Sharrows”), have been introduced for use in California as an additional treatment for Class III facilities. The stencil can serve a number of purposes, such as making motorists aware of bicycles potentially in their lane, showing bicyclists the direction of travel, and, with proper placement, reminding bicyclists to bike further from parked cars to prevent “dooring” collisions. **Figure A-11** illustrates recommended on-street Shared Lane Marking stencil placement. The “Chevron” marking design recommended by Caltrans is shown below in **Figure A-12**. The following pavement markings were adopted for official use by Caltrans on 9/12/2005 as part of the California MUTCD.

Guidance language provided by Caltrans for use of the Shared Lane Marking is as follows:

Section 9C.103 Shared Roadway Bicycle Marking

Option:

The Shared Roadway Bicycle Marking shown in Figure 9C-107 may be used to assist bicyclists with positioning on a shared roadway with on-street parallel parking and to alert road users of the location a bicyclist may occupy within the traveled way.

Standard:

The Shared Roadway Bicycle Marking shall only be used on a roadway which has on-street parallel parking. If used, Shared Roadway Bicycle Markings shall be placed so that the centers of the markings are a minimum of 3.3 m (11 ft) from the curb face or edge of paved shoulder. On State Highways, the Shared Roadway Bicycle Marking shall be used only in urban areas.

Option:

For rural areas, the SHARE THE ROAD (W16-1) plaque may be used in conjunction with the W11-1 bicycle warning sign (see Sections 2C.51 and 9B.18). Information for the practitioner regarding classification of rural versus urban roadways can be found at the following California Department of Transportation website: <http://www.dot.ca.gov/hq/tsip/hpms/page1.php>

Guidance:

If used, the Shared Roadway Bicycle Marking should be placed immediately after an intersection and spaced at intervals of 75 m (250 ft) thereafter. If used, the Shared Roadway Bicycle Marking should not be placed on roadways with a speed limit at or above 60 km/h, (40 mph).

Option:

Where a Shared Roadway Bicycle Marking is used, the distance from the curb or edge of paved shoulder may be increased beyond 3.3 m (11 ft). The longitudinal spacing of the markings may be increased or reduced as needed for

roadway and traffic conditions. Where used, bicycle guide or warning signs may supplement the Shared Roadway Bicycle Marking.

Support:

The Shared Roadway Bicycle Marking is intended to:

- * Reduce the chance of bicyclists impacting open doors of parked vehicles on a shared roadway with on-street parallel parking.
- * Alert road users within a narrow traveled way of the lateral location where bicyclists ride.
- * Be used only on roadways without striped bicycle lanes or shoulders.

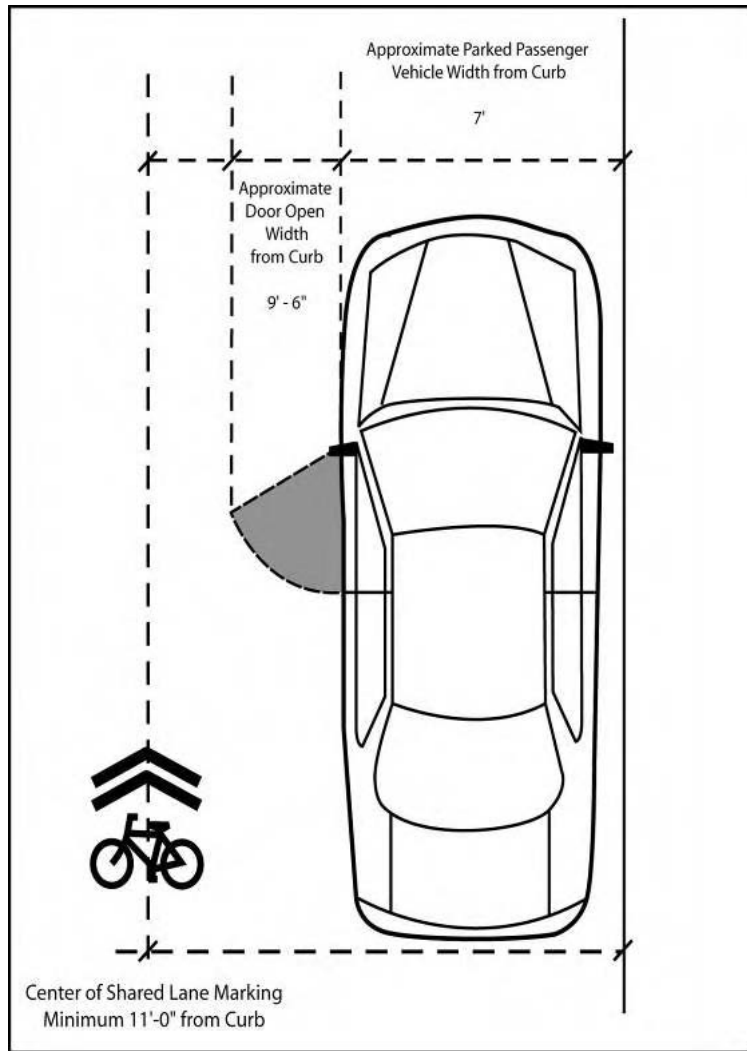

Figure A-11: Shared Lane Marking Placement

Bicycle Boulevard

A bicycle boulevard treatment is typically a lower volume street that parallels a higher volume arterial. Traffic calming typically includes a set of improvements to slow traffic and prevent cut-through traffic such as: traffic circles, chokers, and medians. In addition, stop signs favor bicyclists by stopping perpendicular traffic. Sensor loops activate traffic signals to allow safe crossings of higher volume roadways. The following design considerations apply to a bicycle boulevard:

- Typically used on low volume streets
- Traffic-calmed streets located within 1/4 mile of parallel arterials
- Allows access to key destinations
- Provides safe arterial street crossing for cyclists
- Possible Speed Limit reduction from 25 MPH to 20 MPH

Figure A-13 illustrates a typical bicycle boulevard street configuration.

For more information, see the City of Berkeley Bicycle Boulevard *Design Tools and Guidelines* at <http://www.ci.berkeley.ca.us/transportation/Bicycling/BB/Guidelines/linkpag.htm>

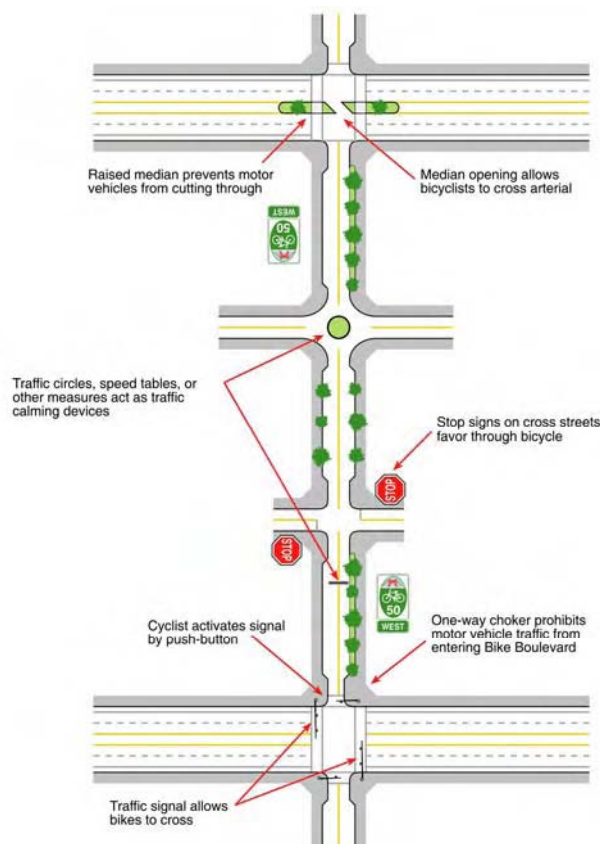

Figure A-13: Example Bicycle Boulevard

Bikeway Support Facilities

In a nationwide Harris Poll conducted in 1991, almost half the respondents stated that they would sometimes commute to work by bicycle, or commute more often, if there were showers, lockers, and secure bicycle storage at work. Cyclists' needs for bicycle parking range from simply a convenient piece of street furniture, to storage in a bicycle locker that affords weather, theft and vandalism protection, gear storage space, and 24-hour personal access. Most bicycles today cost 350 dollars to over 2,000 dollars and are one of the top stolen items in all communities, with components being stolen even when a bicycle is securely locked. Theft can be a serious deterrent to riding, especially for low-income riders or those with particularly expensive or rare bicycles. Where a cyclist's needs falls on this spectrum is determined by several factors:

- **Type of trip being made:** whether or not the bicycle will be left unattended all day or just for a few minutes.
- **Security of area:** determined by the cyclist's perception
- **Value of the bicycle:** the more a cyclist has invested in a bicycle, the more concern she or he will show for theft protection or how prone a given area is to bicycle theft.

A final need for some potential commuting cyclists are shower, locker, and changing rooms at trip destinations. For those cyclists needing to dress more formally, travel longer distances, or cycle during wet or hot weather, the ability to shower and change clothing can be as critical as bicycle storage.

Types of Bicycle Parking

Bicycle parking facilities in California are classified as follows:

Class I: Class I bicycle parking facilities (see **Figure A-14**) accommodate employees, students, residents, commuters, and others expected to park more than two hours. This parking is to be provided in a secure, weather-protected manner and location. Class I bicycle parking will be either a bicycle locker, or a secure area like a 'bike corral' that may be accessed only by bicyclists.

Bike lockers are covered storage units that typically accommodate one or two bicycles per locker, and provide additional security and protection from the elements. These are typically located at large employment center, colleges, and transit stations.

Bike corrals can be found at schools, stadiums, special events, and other locations, and typically involve a movable fencing system that can safely store numerous bicycles. Either locking the enclosure or locating it near other activities so that it can be supervised provides security.

Class II: Class II bicycle parking facilities (see **Figure A-15**) are best used to accommodate visitors, customers, messengers and others expected to depart within two hours. Bicycle racks provide support for the bicycle but do not have locking mechanisms. Racks are relatively low-cost devices that typically hold between two and eight bicycles, allow bicyclists to securely lock their frames and wheels, are secured to the ground, and are located in highly visible areas. They are usually located at schools, commercial locations, and activity centers such as parks, libraries, retail locations, and civic centers. Class II racks are typically located on sidewalks. Due to narrow sidewalk widths in many areas, interest has been increasing in on-street bicycle parking, sometimes in place of car parking spaces (see **Figure A-16** for an example). Note that on-street bicycle parking is an atypical design for Class II bicycle parking for which there are currently no nationally-accepted design guidelines.

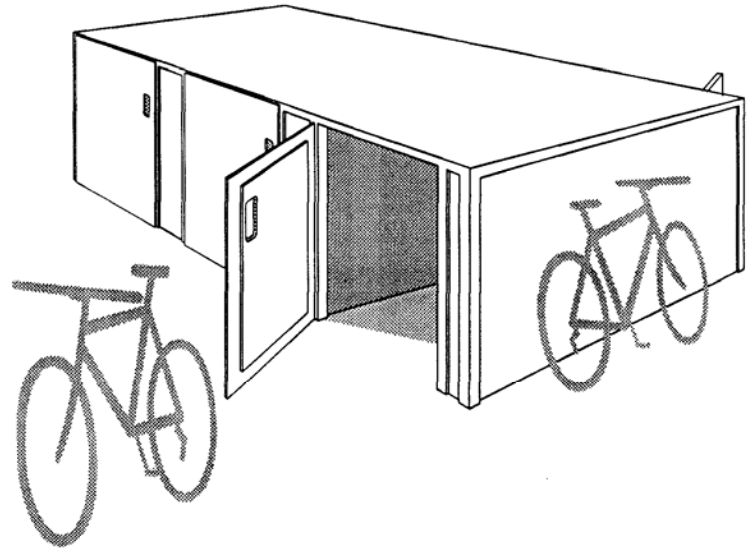
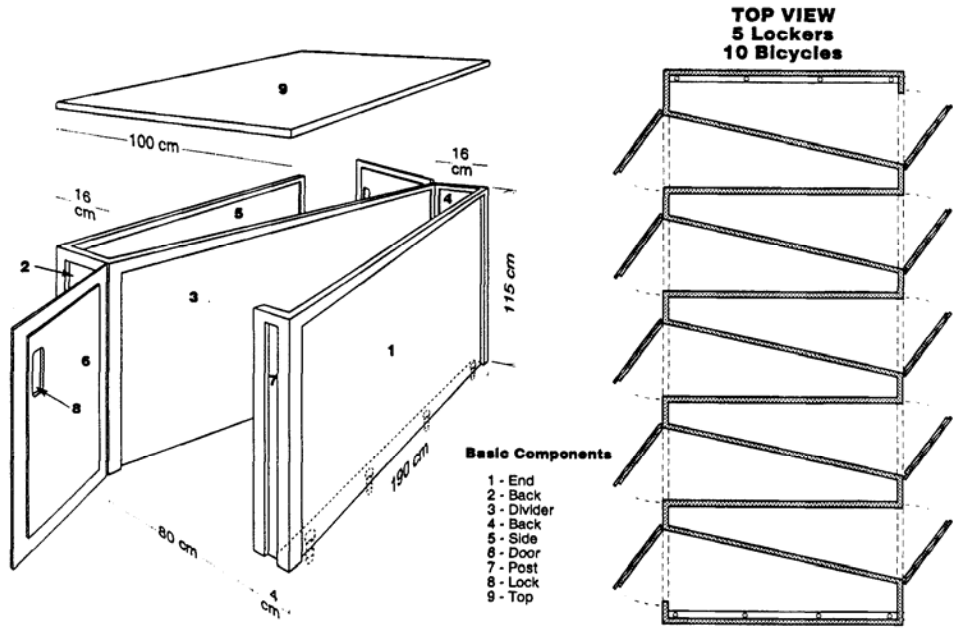

Figure A-14: Class I Bike Lockers

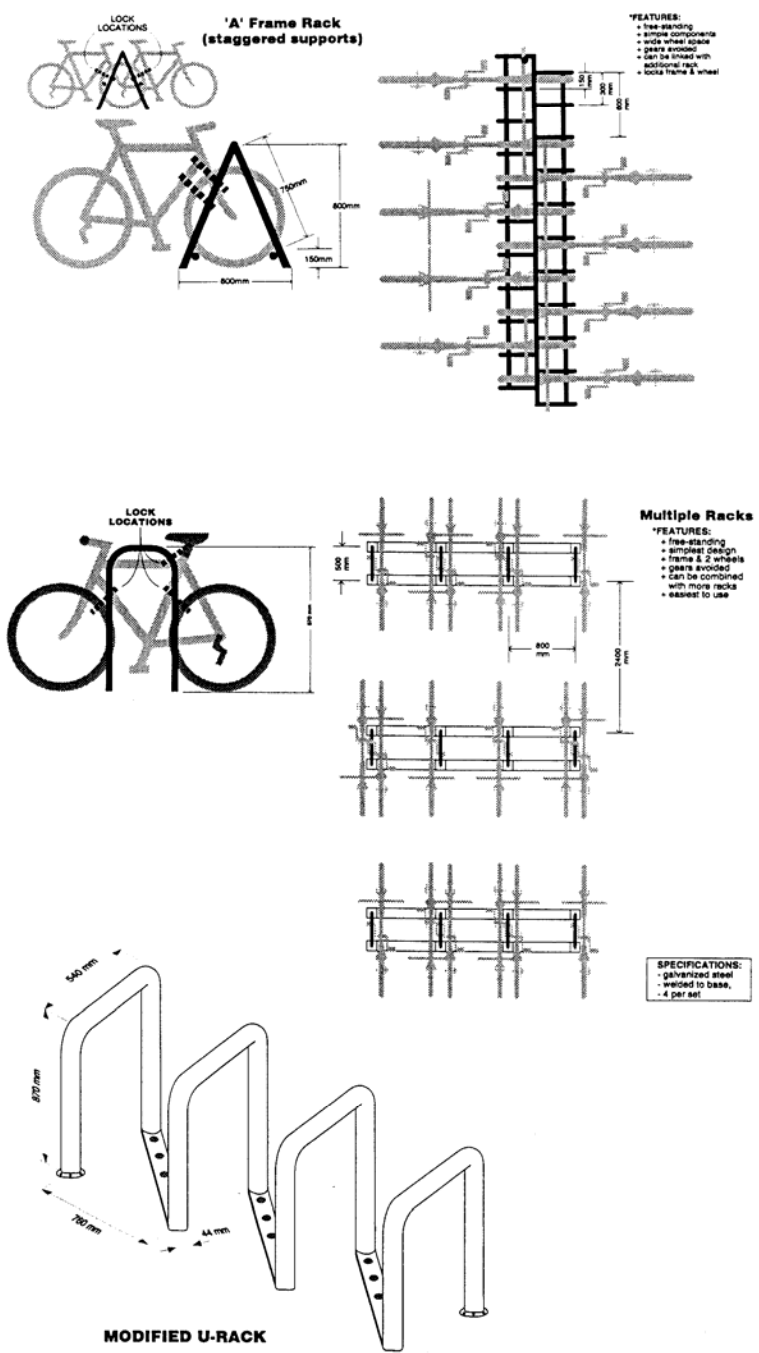
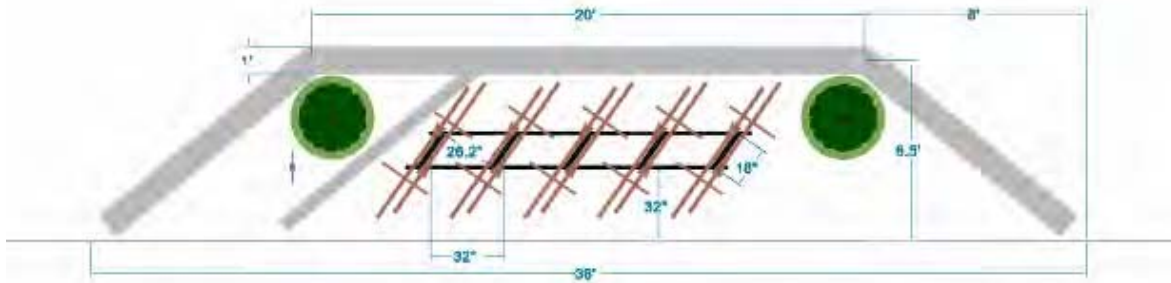

Figure A-15: Class II Racks

On-Street Bicycle Parking
Short-term Design
36' Option



Scale: 1" = 4'

Figure A-16: On-Street Bike Parking

Appendix B: Pedestrian Design Guidelines

Rationale for the Design Guidelines

Pedestrian design guidelines are one effective strategy for improving the overall urban and suburban environment for walking. Other strategies such as enforcement of existing traffic laws, and public information and education are addressed in Chapter 5. The following guidelines primarily address issues of pedestrian safety. The guidelines do not thoroughly address issues of urban design, design character, or the many other amenities that make streets and sidewalks attractive places to travel and spend time as a pedestrian. It is clear that safety concerns can significantly influence a person's decision to walk or use other modes of transportation, thus design guidelines for creating a safe pedestrian environment are an important step for all communities.

Even though pedestrians are legitimate roadway users, they are frequently overlooked in the quest to build more-sophisticated transportation systems. Whether building new infrastructure or renovating existing facilities, it should be assumed that people will walk, and plans should be made to accommodate pedestrians. Where people aren't walking, it is often because they are prevented or discouraged from doing so. Either the infrastructure is insufficient, has serious gaps, or there are safety hazards.

These design guidelines present many design and infrastructure improvements that will help to circumvent this pattern and initiate a new trend in roadway design to better accommodate pedestrians and build a stronger walking community.

Implementation of guidelines shown herein require the approval of the respective County or City Engineer.

State and Federal Guidelines

The design of many streetscape elements is regulated by state and federal law. Traffic control devices must follow the procedures set forth in the Manual of Uniform Traffic Control Devices (MUTCD), while elements such as sidewalks and curb cuts must comply with guidelines implementing the Americans with Disabilities Act (ADA).

Manual of Uniform Traffic Control Devices

Stanislaus County follows the procedures and policies set out in the MUTCD. Traffic control devices include traffic signals, traffic signs, and street markings. The manual covers the placement, construction, and maintenance of devices. The MUTCD emphasizes uniformity of traffic control devices to protect the clarity of their message. A uniform device conforms to regulations for dimensions, color, wording, and graphics. Uniformity also means treating similar situations in the same way.

Americans with Disabilities Act

Title II of the Americans with Disabilities Act (ADA), signed into law in 1990, is a civil rights act that prohibits public entities from discrimination on the basis of disability. Newly constructed facilities must be free of architectural barriers that restrict access or use by individuals with disabilities. Cities in California uses two technical standards for accessible design: the Americans with Disability Act Accessibility Guidelines (ADAAG), adopted by the Department of Justice for places of public accommodation and commercial facilities covered by Title 3 of the ADA, and the California Title 24 State Accessibility Standards, State Architectural Regulations for Accommodation of the Physically Handicapped in Public Facilities.

Principles for Pedestrian Design

The following design principles represent a set of ideals which should be incorporated, to some degree, into every pedestrian improvement. They are ordered roughly in terms of relative importance.

1. The pedestrian environment should be safe. Sidewalks, walkways, and crossings should be designed and built to be free of hazards and to minimize conflicts with external factors such as noise, vehicular traffic, and protruding architectural elements.
2. The pedestrian network should be accessible to all. Sidewalks, walkways, and crosswalks should ensure the mobility of all users by accommodating the needs of people regardless of age or ability.
3. The pedestrian network should connect to places people want to go. The pedestrian network should provide continuous direct routes and convenient connections between destinations, including homes, schools, shopping areas, public services, recreational opportunities and transit.
4. The pedestrian environment should be easy to use. Sidewalks, walkways, and crossings should be designed so people can easily find a direct route to a destination and will experience minimal delay.
5. The pedestrian environment should provide good places. Good design should enhance the look and feel of the pedestrian environment. The pedestrian environment includes open spaces such as plazas, courtyards, and squares, as well as the building facades that give shape to the space of the street. Amenities such as seating, street furniture, banners, art, plantings, shading, and special paving, along with historical elements and cultural references, should promote a sense of place.
6. The pedestrian environment should be used for many things. The pedestrian environment should be a place where public activities are encouraged. Commercial activities such as dining, vending, and advertising may be permitted when they do not interfere with safety and accessibility.
7. Pedestrian improvements should preserve or enhance the historical qualities of a place. Stanislaus history must be preserved in the public space. Where applicable, pedestrian improvements should restore and accentuate historical elements of the public right-of-way. Good design will create a sense of time that underscores the history of Stanislaus.
8. Pedestrian improvements should be economical. Pedestrian improvements should be designed to achieve the maximum benefit for their cost, including initial cost and maintenance cost as well as reduced reliance on more expensive modes of transportation. Where possible, improvements in the right-of-way should stimulate, reinforce, and connect with adjacent private improvements.

Sidewalk Corridor Guidelines

The width and zone guidelines presented in this sidewalk section would apply to sidewalks in new development areas, redevelopment areas, and in areas where street reconstruction is planned. For the entire above listed project types, sufficient right of way must exist for implementation of the appropriate sidewalk width guideline.

Sidewalk Corridor Width

Proposed sidewalk guidelines apply to new development and depend on available street width, motor vehicle volumes, surrounding land uses, and pedestrian activity levels. Standardizing sidewalk guidelines for different areas, dependent on the above listed factors, ensure a minimum level of quality for all sidewalks.

Stanislaus currently installs sidewalks that conform to the Americans with Disabilities Act Accessibility Guidelines (ADAAG) that call for minimum 4-foot wide sidewalks for passage.

The Institute of Transportation Engineers (ITE) recommends planning all sidewalks to include a minimum width of 5 feet (60 inches) with a planting strip of 2 feet (24 inches) in both residential and commercial areas.

Sidewalk Zones

Sidewalks are the most important component of Stanislaus County pedestrian circulation network. Sidewalks provide pedestrian access to virtually every activity and provide critical connections between other modes of travel, including the automobile, public transit, and bicycles. The Sidewalk Corridor (**Figure B-1**) is typically located within the public right-of-way between the curb or roadway edge and the property line. The Sidewalk Corridor contains four distinct zones: the Curb Zone, the Furnishings Zone, the Through Pedestrian Zone, and the Frontage Zone.

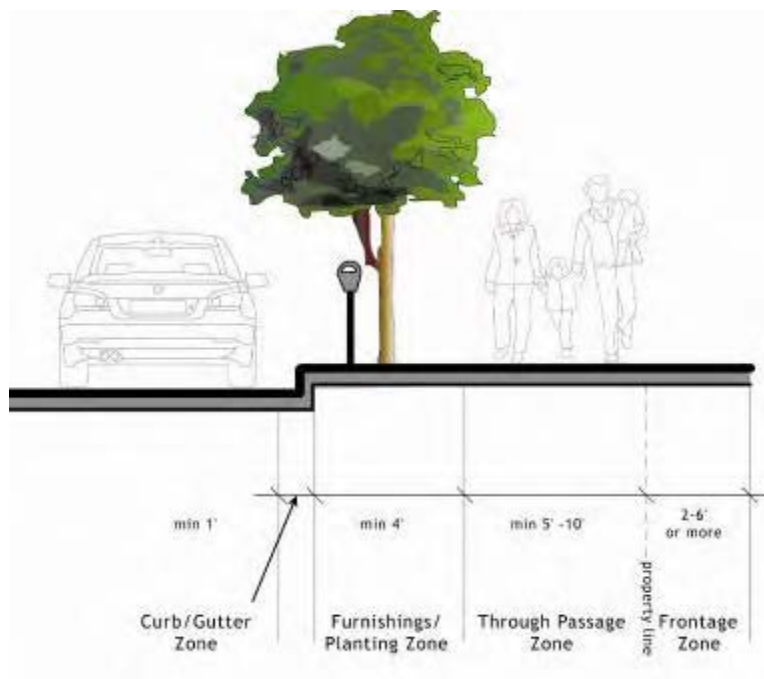

Figure B-1: Sidewalk Zones

Curb Zone

Curbs prevent water in the street gutters from entering the pedestrian space, discourage vehicles from driving over the pedestrian area, and make it easy to sweep the streets. In addition, the curb helps to define the pedestrian environment within the streetscape, although other designs can be effective for this purpose. At the corner, the curb is an important tactile element for pedestrians who are finding their way with the use of a cane. Strait curbs rather than rolled curbs are strongly recommended because it eliminates the potential for cars to park on the sidewalk or partially obstructing the sidewalk.

Furnishings Zone

Most streets require a utility zone to accommodate above ground public infrastructure, signage, and street trees. Locating this infrastructure in the furnishings zone prevents it from encroaching on the through passage zone, where it is likely to cause accessibility issues. The furnishings zone also creates an important buffer between pedestrians and vehicle travel lanes by providing horizontal separation. Elements like utility poles, sign posts, and street trees improve pedestrian safety and comfort by further separating the sidewalk from moving vehicles. Guidelines for furnishings zone widths are presented below in **Table B-1**.

Through Passage Zone

Most residential areas outside the downtown area in Stanislaus are low to medium density and therefore have lower pedestrian volumes, compared to more urbanized areas such as the downtown and adjacent neighborhoods. A four to five foot minimum through passage zone is recommended for these conditions, depending on available right of way. Some commercial areas, school zones, and other public areas generate greater pedestrian volumes and should have a wider through zone. Table C-1 presents recommended standards for the through zone width for each of the predominant land uses in Stanislaus County.

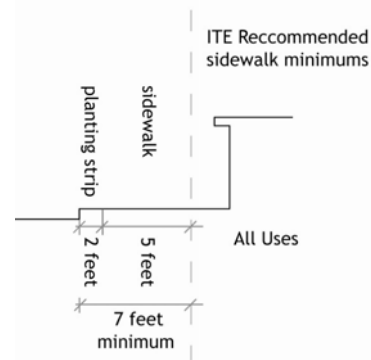

Figure B-2: Sidewalk Minimums

Frontage Zone

The frontage zone is the space between the pedestrian through zone and the adjacent property line. Pedestrians tend to avoid walking close to barriers at the property line, such as buildings, storefronts, walls or fences, in the same way that they tend to avoid walking close to the roadway. In most cases the frontage zone should be at least 12 inches. However, if the sidewalk is adjacent to a wide open or landscaped space, such as in residential areas where fences are not typically found or not allowed, the frontage zone can be eliminated. Guidelines for frontage zone widths are presented in **Table B-1**. As shown in the table, a frontage zone may not be required in many residential areas of Stanislaus due to lack of public right of way or deep yard setbacks.

Table B-1: Recommended Minimum Zone Widths By Street Type

Street Type	Curb Zone	Utility Zone (Buffer Zone)	Through Passage Zone	Frontage Zone	Total Sidewalk Width
Arterial and Collector Street	1 ft.	2-4 ft.	5-8 ft.	2 ft.	10-15 ft.
Local Neighborhood Street	0-1 ft.	0-2 ft.	4-5 ft.	none	4-8 ft.
Commercial Walkways	1 ft.	2-4 ft.	8-10 ft.	2 ft.	13-17 ft.
Multi-Use Trail	NA	4 ft. graded soft surface (2 ft. either side)	8-10 ft. (two-way travel)	NA	12-14 ft.

Sidewalk Cross Section Examples

Basic sidewalk cross-section examples are presented on the following pages. These recommendations consist of both prototype and site-specific types and are intended to complement existing local and Caltrans roadway standards and the design guidelines provided above.

New Sidewalks in Residential Neighborhoods

Although not every neighborhood may desire sidewalks, there will be places that could benefit from their installation. Safer trips by schoolchildren, shopping trips and recreation are just some of the reasons that a community may wish to see sidewalks built in one of their existing neighborhoods.

Sidewalks on Narrow Streets

Figure B-3 shows the minimal solution for new sidewalks in existing neighborhoods. It shows a site constrained by a small setback to the existing house or significant landscaping and a narrow street condition that does not allow for a parking lane between the pedestrians on the sidewalk and the vehicular travel lane.

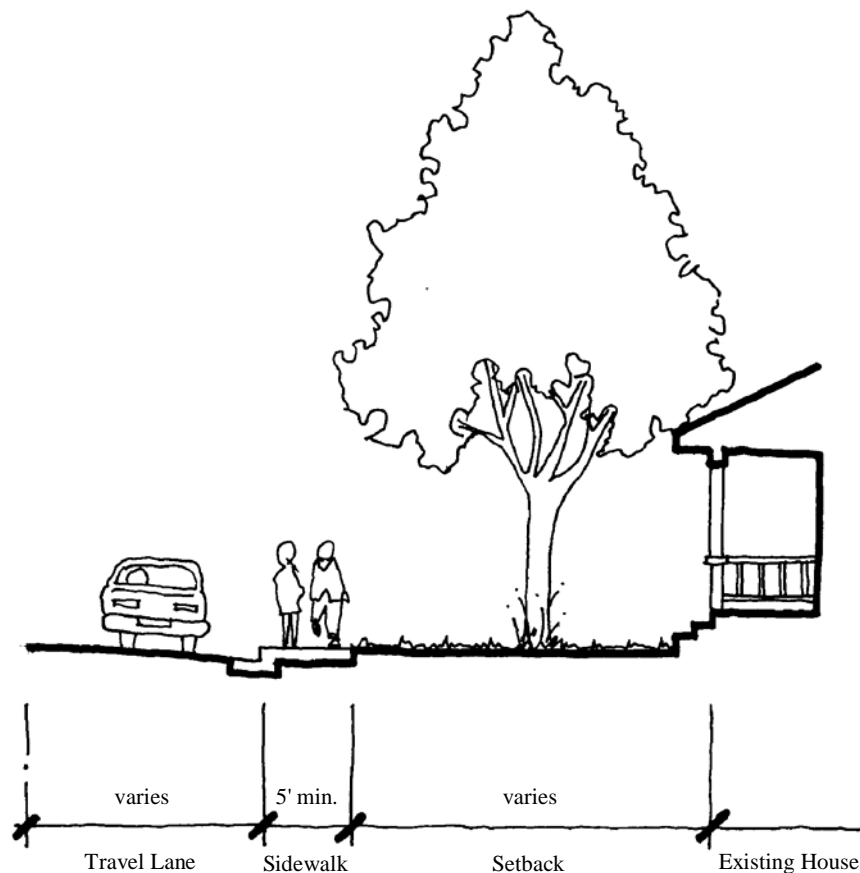

Figure B-3: Sidewalks on Narrow Streets

Sidewalks on Wider Streets

Figure B-4 demonstrates the preferred design where a lane of parking between the pedestrian way and the traffic lane. A parking lane is generally preferred for pedestrian safety since it separates pedestrians from moving cars. If the street is not wide enough to install this improvement, and the existing house or landscaping is set back far enough, the possibility of acquiring land to widen the right-of-way should be investigated.

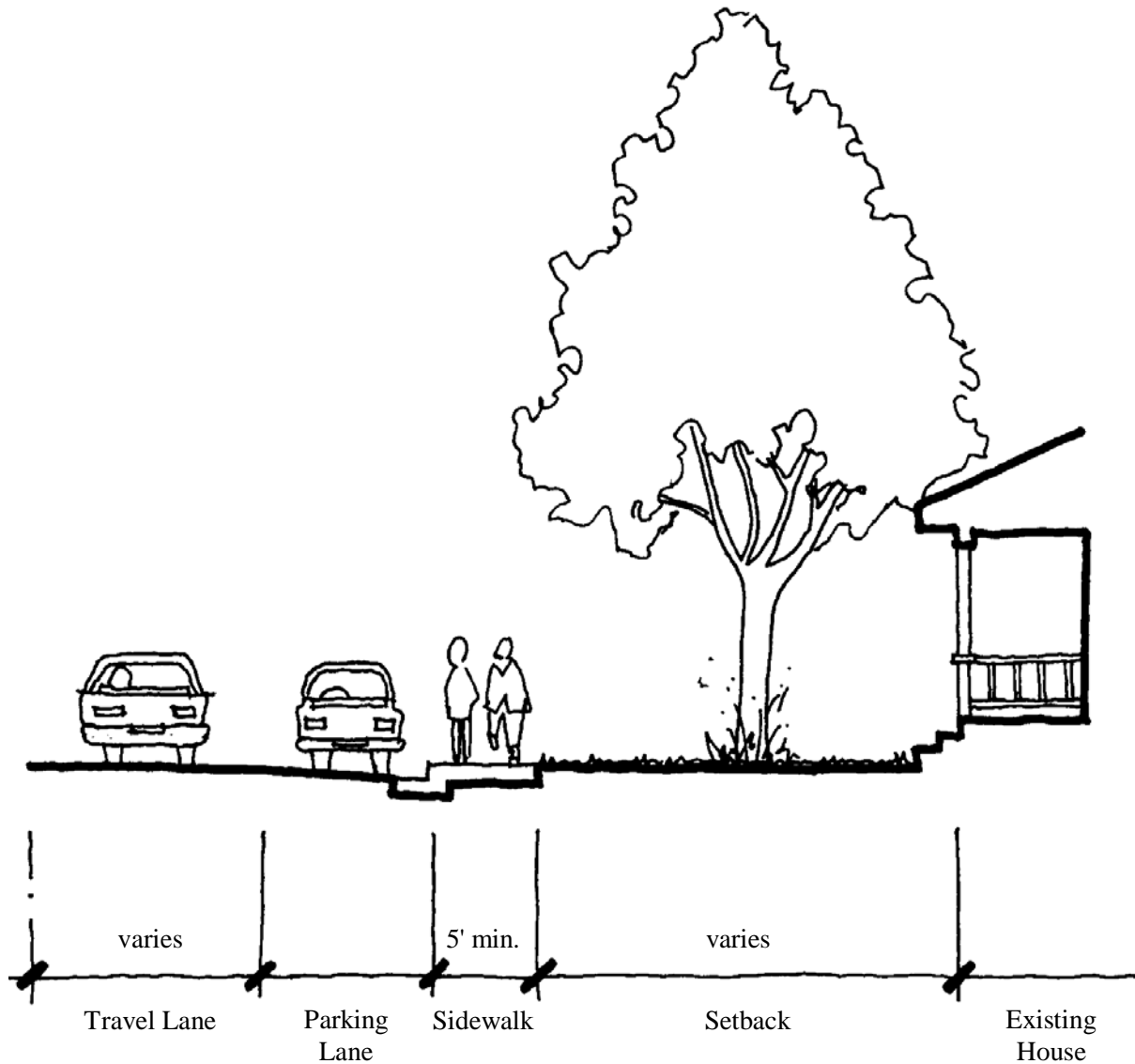

Figure B-4: Sidewalks on Wider Streets

Sidewalk with Planting Strip

The most desirable condition, as illustrated in **Figure B-5**, is for the pedestrian to be buffered from vehicular traffic by both a parking lane and a planting strip. This is particularly important on streets with higher traffic volumes. Ideally, the planting strip should contain street trees at an interval of 20 to 50 feet on center. The trees help to create a more amenable pedestrian corridor and give better spatial definition to the street. This can make the street appear narrower, which helps to slow vehicular traffic.

If the street is not wide enough to install this improvement, and the existing house or landscaping is set back far enough, the possibility of acquiring land to widen the right-of-way should be investigated.

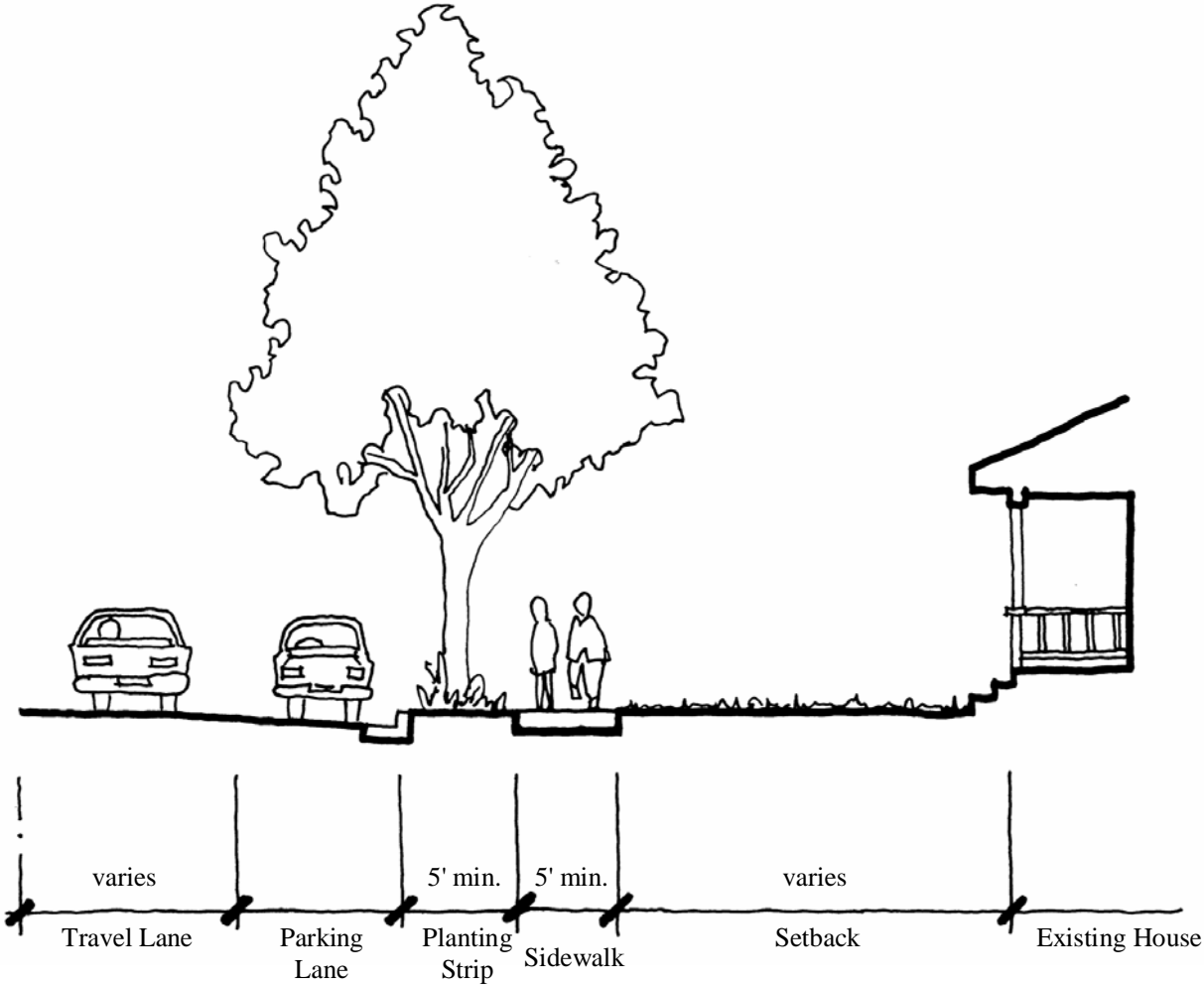

Figure B-5: Sidewalk with Planting Strip

Furnishings Zone

Figure B-6: Furnishing Zone



The Furnishings Zone buffers pedestrians from the roadway and is the place for elements such as street trees, poles, parking meters, and street furniture.

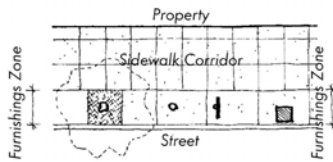

Typical alignment of the furnishings zone within the sidewalk corridor

Figure C-7: Ventilation Grates

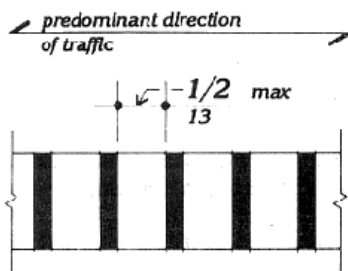

Ventilation grates should have openings of 1/2 inch max.

The Furnishings Zone buffers pedestrians from the adjacent roadway, and is also the area where elements such as street trees, signal poles, utility poles, street lights, controller boxes, hydrants, signs, parking meters, driveway aprons, grates, hatch covers, and street furniture are properly located. This is the area where people alight from parked cars.

Wherever it is wide enough, the Furnishings Zone should include street trees. In commercial areas, this zone may be paved, with tree wells and planting pockets for trees, flowers, and shrubs. In other areas, this zone generally is not paved except for access walkways, but is landscaped with some combination of street trees, shrubs, ground cover, lawn, or other landscaping treatments.

Separating pedestrians from travel lanes greatly increases their comfort as they use the Sidewalk Corridor. This buffer function of the Furnishings Zone is especially important on streets where traffic is heavy, yet along many of these streets the existing Sidewalk Corridor is narrow. Where possible, additional width should be given to this zone on streets with traffic speeds over 35 mph (55 km/h).

Grates

All grates within the sidewalk shall be flush with the level of the surrounding sidewalk surface, and shall be located outside the Through Pedestrian Zone. Ventilation grates and tree well grates shall have openings no greater than 1/2 in (13 mm) in width.

Designers should use tree well grates in High Pedestrian Use areas.

Hatch Covers

Hatch covers should be located within the Furnishings Zone. Hatch covers must have a surface texture that is rough, with a slightly raised pattern. The surface should be slip-resistant even when wet. The cover should be flush with the surrounding sidewalk surface.

Street Furniture

Street furniture includes benches, mailboxes, trash and recycling receptacles, bike racks, newspaper boxes, drinking fountains, information boards, kiosks, parking meters, artwork, public phones, signs, bus shelters, and other items used by pedestrians. These features humanize the scale of a street and encourage pedestrian activity. Street furniture should be placed in the furnishings zone to maintain through passage zones for pedestrians and to provide a buffer between the sidewalk and the street. For bus shelters on crowded sidewalks, bus bulb-outs are recommended for providing additional space. Bus shelters should also have clearly displayed bus schedules and city maps for way-finding. Pedestrian facilities around all street furniture should meet accessibility requirements and pedestrian walk clearance zones.

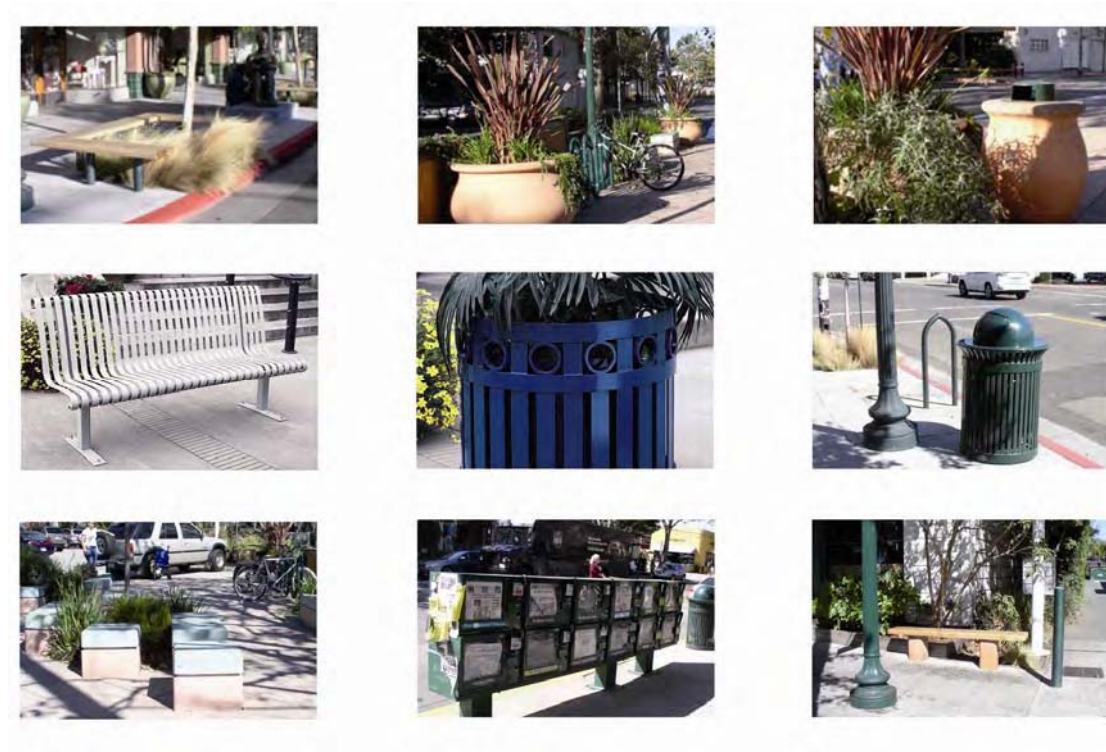

Figure B-8: Examples of Street Furniture

Utility Poles and Structures

The underground and overhead network of utility services greatly impacts sidewalks. Utility poles, traffic signals, and fire hydrants should be installed outside the pedestrian travel zone. Electrical boxes should be located on utility and traffic signal poles so they do not create unexpected hazards to pedestrians. Utility vaults and access boxes should be located outside the pedestrian travel zone and be constructed from non-slip materials that are flush with the sidewalk, in conformance with ADA requirements.

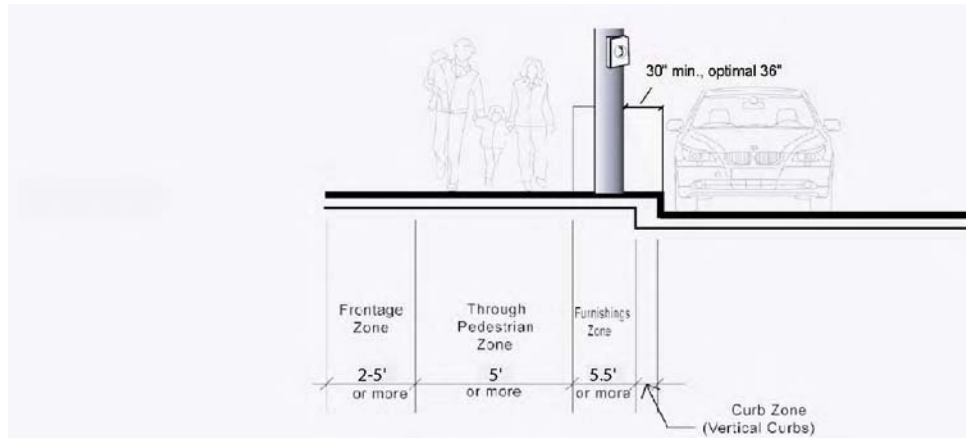

Figure B-9: Utility Poles and Structure Placement

Through Pedestrian Zone

The Through Pedestrian Zone is the area intended for pedestrian travel. This zone should be entirely free of permanent and temporary objects.

For sidewalk infill projects in areas with some existing sidewalks, the new sidewalk should match the existing width or meet the recommended width whichever is larger.

Driveway aprons should not intrude into the Through Pedestrian Zone.

ADA Accessibility Guidelines specify that the minimum clearance required for through passage is 36 inches. A minimum clearance of 32 inches is allowed, but only up to a length of 24 inches.

Surfaces

Walking surfaces shall be firm and stable, resistant to slipping, and allow for ease of passage by people using canes, wheelchairs, or other devices to assist mobility.

Sidewalks are generally constructed of Portland cement concrete. Brick or concrete unit pavers may also be used, at the discretion of the respective County or City Engineer, particularly in the Furnishings Zone or around mature trees where sidewalk lifting is a problem.

The surface of concrete sidewalks should be scored to match historic patterns within a neighborhood or district where appropriate.

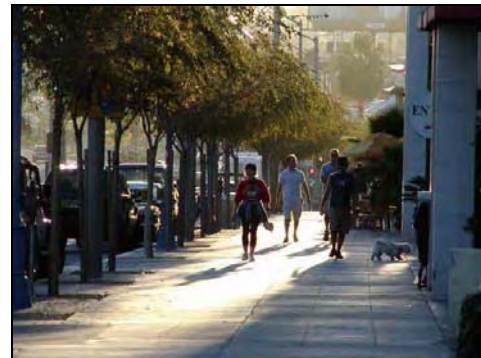

The through pedestrian zone is the area of the sidewalk corridor intended for pedestrian travel.

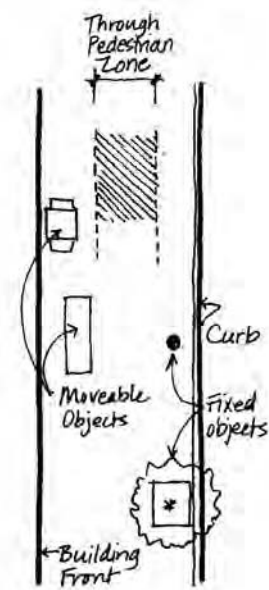

Figure B-10: Through Pedestrian Zone

Table B-2: Sidewalk Materials

Concrete	
Where to Use	Preferred material for use on standard city sidewalks.
Maintenance Life	75 years plus
Comparative Cost (2007)	\$10/sq ft
Concrete Pavers	
Where to Use	Acceptable material for use on sidewalks where aesthetic treatment is desired, at the discretion of the respective County or City Engineer. May be best suited for the Furnishings Zone as streetscape accent where pedestrian through travel is not expected.
Maintenance Life	20 years plus
Comparative Cost (2007)	\$15/sq ft
Rubber Sidewalk	
Where to Use	Experimental sidewalk material being applied in select locations in cities including Berkeley, Santa Monica and Washington DC, where cracking and tree root uplifting are problems.
Maintenance Life	Insufficient data
Comparative Cost (2007)	\$15/sq ft
Asphalt	
Where to Use	Preferred material for use on any widened shoulder alternative pathway. Acceptable but not preferred as a material for separated alternative pathways or connector paths. Asphalt patch may be used for use for standard sidewalk only for temporary repair.
Maintenance Life	10 years plus
Comparative Cost (2007)	\$5/sq ft

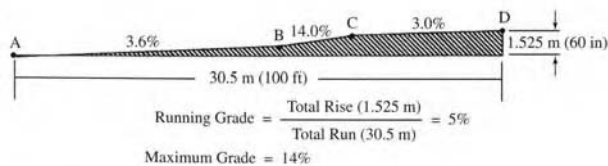

Figure B-11: Running Grade and Maximum Grade

Grade

The grade of a sidewalk is important because of the issues of control, stability, and endurance. Gentle grades are preferred to steep grades so as to make it possible for people to go up hill, so that they don't lose control on the downhill, and so that they don't lose their footing.

- Grade is the slope parallel to the direction of travel.
- Running grade is the average grade along a continuous path.
- Maximum grade covers a limited section of sidewalk that exceeds the running grade. It is measured over 24 in (0.610 m). The above figure illustrates running grade and maximum grade. Rate of change of grade is the change of grade over a distance of 24 in (0.610 m) intervals.
- Counter slope is the grade running opposite to the running grade.
- New sidewalks must be built to comply with these grade requirements and approval of the respective County or City Engineer. However, in a steep area with existing roadways, exceptions are allowed. Staircases and/or elevators can provide an alternative.

Cross Slope

Cross-slope affects the stability of wheelchairs, walking aids, and people who have difficulty walking but don't use aids. All sidewalks require some cross-slope for drainage, but cross-slope that is too great presents problems for disabled users. The recommended cross-slope for sidewalks is 2%. The preferred cross slope for the entire paved sidewalk corridor is 1:50. If a greater slope is anticipated because of unusual topographic or existing conditions, the designer should maintain the preferred slope of 1:50 within the entire Through Pedestrian Zone, if possible.

This can be accomplished either by raising the curb so that the cross-slope of the entire sidewalk can be 1:50, or by placing the more steeply angled slope within the Furnishings Zone and/or the Frontage Zone (see illustration).

If the above measures are not sufficient and additional slope is required to match grades, the cross slope within the Through Pedestrian Zone may be as much as 1:25, provided that a 3 ft (900 mm) wide portion within the Through Pedestrian Zone remains at 1:50 cross slope, as shown in the illustration.

Note: Use of cross slope guidelines herein shall require approval of respective County or City Engineer.

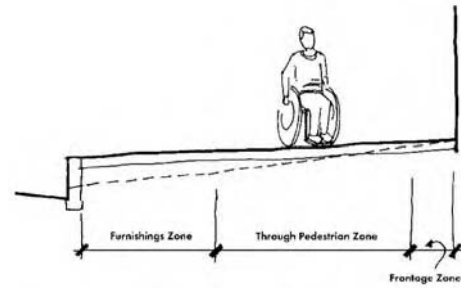
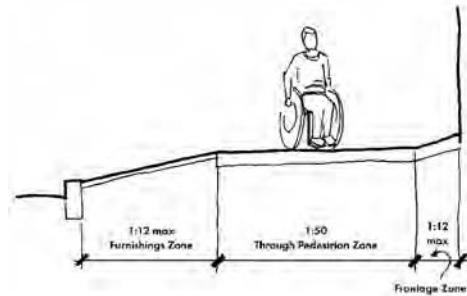
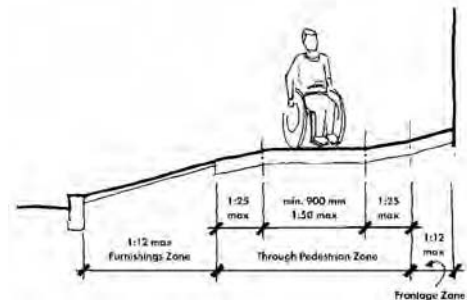

Figure B-12: Cross Slope

Raising the curb is one approach to maintaining the preferred cross slope.



The Furnishings Zone and the Frontage Zone may be sloped more steeply, provided the preferred cross slope is maintained in the Through Pedestrian Zone.



If necessary, the Through Pedestrian Zone may contain slopes up to 1:25, provided a 900 mm (3'-0") wide area with a cross slope of no more than 1:50 is maintained within the zone.

Frontage Zone



Temporary uses such as sidewalk cafes may occupy the Frontage Zone, providing the Through Pedestrian Zone remains clear.

Elements such as standpipe systems may project into the Frontage Zone. Care must be taken to assure compliance with the ADA.



Figure B-13: Frontage Zone

The Frontage Zone is the area between the Through Pedestrian Zone and the property line. This zone allows pedestrians a comfortable “shy away” distance from the building fronts, in areas where buildings are at the lot line, or from elements such as fences and hedges on private property.

Where no Furnishings Zone exists, elements that would normally be sited in that zone, such as transit shelters and benches, telephone kiosks, signal and street lighting poles and controller boxes, traffic and parking signs, and utility poles, may occupy the Frontage Zone. In some cases, easements or additional right-of-way may be required to allow for these items. For residential and mixed-use building built to the right-of-way line, these elements should not be sited in the Frontage Zone, as they could block access to an existing or future building.

Private temporary uses such as sidewalk cafes (where allowed by Code) may occupy the Frontage Zone, so long as the Through Pedestrian Zone is maintained.

Encroachments

Fences and walls, when permitted, should be at least 1 ft (300 mm) behind the back of the sidewalk (or the future sidewalk, if none exists). Encroachments into the right-of-way should not be permitted where the existing sidewalk corridor is less than the recommended width. Property owners should check with their Planning Department in identifying property lines.

Elements such as standpipe systems for fire safety may project into the Frontage Zone from a building face a maximum of 1 ft (300 mm), but not more than 4 in (100 mm) if they project in the area between 2 ft 3 in and 6 ft 8 in (685 mm and 2030 mm) above the sidewalk, per the ADA.

Railroad crossings

At-grade railroad tracks can be hazardous for pedestrians to cross. Improvements can be made to alert pedestrians that they are crossing tracks and that there is an oncoming train. One example is recommended in the Projects Chapter of this Plan, truncated domes at crossings. Truncated domes help alert pedestrians as they are walking to cross the tracks with some caution. There are also other improvements that can help warn pedestrians of railroad crossings, such as signage. Railroad crossing warning signs can be placed near the sidewalk/railroad crossing. Another improvement is an arm that crosses the sidewalk when a train is approaching like arms that lower to stop vehicles approaching at-grade crossings. **Figure B-14** shows how these railroad arms are attached to the same pole as the arm to stop vehicles and they cross the sidewalk, warning pedestrians of a train.

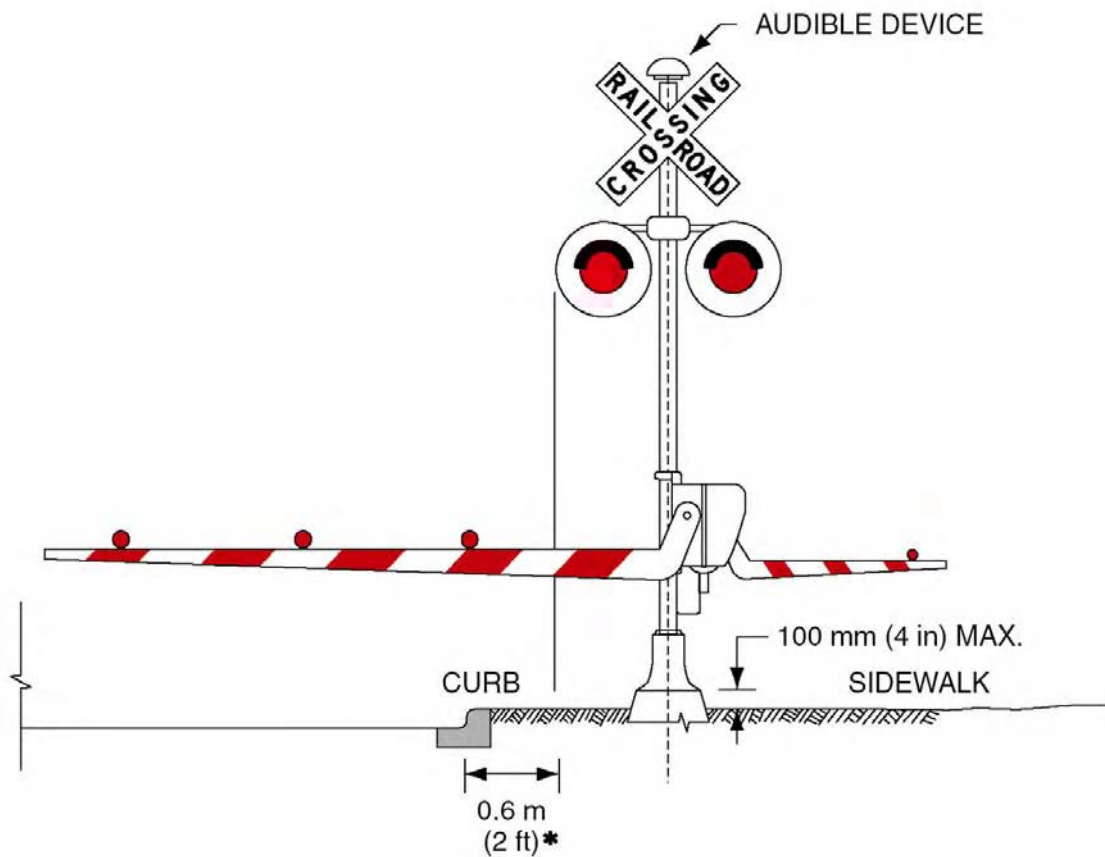
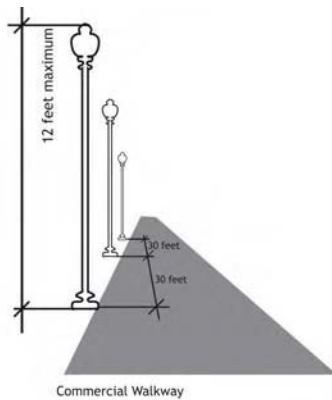

Figure B-14: Railroad Arm on Sidewalk

Sidewalk Lighting

Improving street lighting makes locations appear more inviting and will encourage people to use pedestrian areas at night. An increase in the number of people using a particular area reinforces general safety by eliminating opportunities for crimes to occur.

Street lighting is designed to serve a variety of purposes. Some designers use lamp styles to provide a sense of neighborhood continuity or preserve the atmosphere of an historic district. Others use lights to improve visibility for motorists at a particular intersection.



**Figure B-15:
Lighting Placement**

Pedestrian scale lighting is addressed specifically in this section, as typical roadway right-of-way lighting designed to benefit motorists is of little value to pedestrians. From the pedestrian's point of view, frequent lampposts of lower height and illumination are preferred over fewer lampposts that are taller and brighter.

Pedestrian scale lighting should be used in areas of high pedestrian activity and where feasible based on available right of way, utilities and cost. Pedestrian scale lighting is a significant capital improvement and should be planned only where it will have a maximum benefit. The areas in San Benito that may benefit from increased pedestrian lighting surround uses active in the evening such as entertainment districts that include theatres, restaurants and bars or parks with evening programs. Pedestrian scale lighting may also benefit the pedestrian districts where they do not exist already.

Pedestrian scale lighting may be installed between existing lampposts to obtain the frequencies given in the table above. They must be located at least ten feet from the full growth canopy of adjacent trees.

The cities within San Benito County may have minimum lighting standards included in their Municipal Code. This section is intended to provide guidelines for additional lighting to create a more pedestrian friendly environment.

Landscape

Trees can help create a more attractive streetscape, providing visual relief year round and shade in summer, improving air quality, and creating a buffer between pedestrians and automobiles. Trees should only be planted on streets that have adequate sidewalk widths to maintain a minimum 5 foot path of travel. On sidewalks that are too narrow to accommodate trees without infringing on the pedestrian travel zone or utilities, residents may request that the City plant a tree in their yard near the sidewalk. Trees can be planted in curb extensions provided they do not interfere with the visibility of pedestrians waiting to cross the street or motorists turning corners. Trees should not be planted where they would be in the way of people getting on or off buses or interfere with the operation of utilities.

The selection of trees should be coordinated with list of approved tree species developed by the City arborist. The list is included within the City's Design and Procedures Manual. The City arborist has also developed a list of recommended tree types and minimum planting dimensions to ensure that both the public investment in tree planting maintenance and sidewalk infrastructure are preserved. This appendix is included at the end of the document.

In general select trees with root systems that won't become a trip hazard. Continued review will be conducted on types of trees and planting techniques to maintain accessible sidewalks. Trees should be pruned to ensure that their

branches do not interfere with pedestrian and vehicular visibility and movement. On the sidewalk side, 8 feet of vertical clear space above the ground should be maintained; on the roadway side, 14 feet vertical clear space should be maintained.

Bicycle Parking

Many errands are multi-modal, involving walking and some other transport including vehicles, transit, or bicycle. Placing bicycle parking adjacent to store fronts, shopping centers or post offices may encourage people to bicycle to places that are too far to walk and too close for driving. To facilitate walking-bicycling trips, bicycle parking spaces can be installed in any of the zones identified except the “Through Passage Zone”. If installed in the curb zone, racks must be a minimum of 3.5 feet from the curb and cannot obstruct the path of travel. If installed in the furnishing zone, racks parallel to the curb must be a minimum of 18 inches from the curb. On narrow sidewalks, bicycle parking is oriented so the locked bicycle is parallel to the pedestrian traffic flow. On streets with very wide sidewalks, bicycle parking may also be oriented with locked bicycles perpendicular to the right-of-way as long as they do not project into the pedestrian travel zone. Private property owners are also encouraged to provide bicycle parking for use by the public on their land within the “Frontage Zone”. Such parking should be installed so that locked bicycles do not project into the sidewalk. Bicycle parking rings on posts are designed to prevent bicycles from falling and becoming an obstacle to walking.

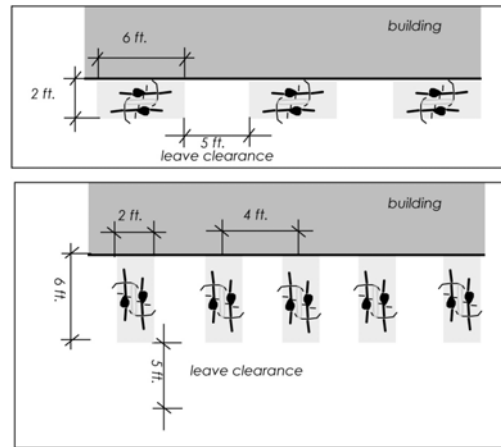
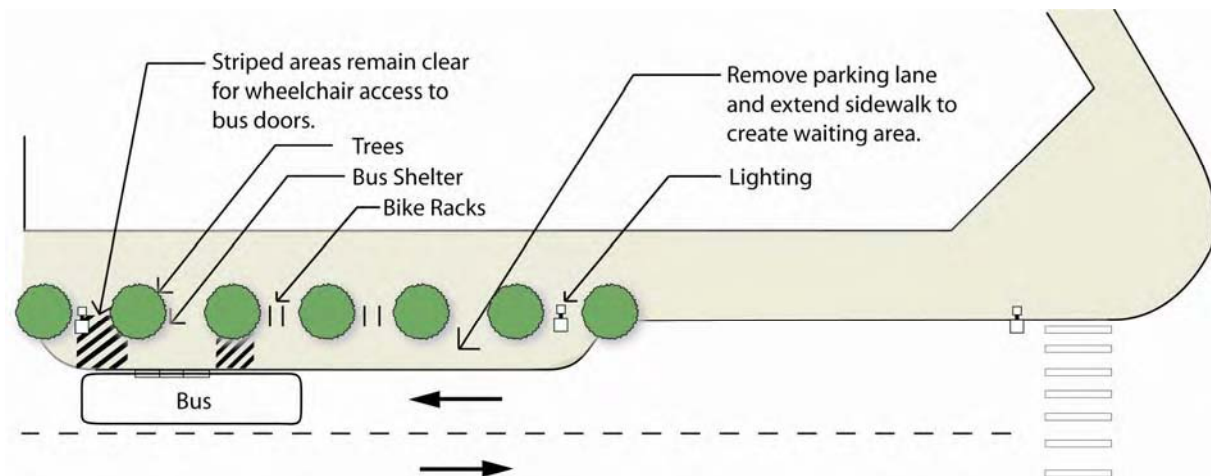

Figure B-16: Typical Bicycle Parking Facility Dimensions

Transit Stops

Bus bulb outs can provide safe access for transit passengers. Bus bulb outs should be designed such that pedestrians in wheelchairs can access the bus shelter and board the bus. One possible design example is shown below in **Figure B-17**. At transit stops where neither a bus turnout nor bus bulb out can be accommodated; buses are often unable to pull directly adjacent to the curb to deploy a lift. Curb ramps in such locations allow wheelchair users to board the bus from the street; if a bus stop is not adjacent to a corner curb ramp, a curb ramp at the bus stop should be provided.

ADA Guidelines define the amount of space necessary next to bus shelters to facilitate the lift operations for passengers in wheelchairs. The ADA minimum requirements for this space are 60 inches wide (as measured along curb or roadway edge) by 96 inches deep (as measured from the curb or roadway edge). ADA Guidelines also state that a passing space of 60 inches is required for passing space adjacent to any sidewalk amenities



Source: Improving Pedestrian Access to Transit: An Advocacy Handbook

Figure B-17: Accessible Bus Bulb Out

Crosswalks

Definition

The California Vehicle Code Section 275 defines a crosswalk as either:

That portion of a roadway included within the prolongation or connection of the boundary lines of sidewalks at intersections where the intersecting roadways meet at approximately right angles, except the prolongation of such lines from an alley across a street.

Any portion of a roadway distinctly indicated for pedestrian crossing by lines or other markings on the surface.

Notwithstanding the foregoing provisions of this section, there shall not be a crosswalk where local authorities have placed signs indicating no crossing.

At intersections, a crosswalk is effectively a legal extension of the sidewalk across the roadway. Crosswalks are present at all intersections, whether marked or unmarked, unless the pedestrian crossing is specifically prohibited by the local jurisdiction. At mid-block locations, crosswalks only exist if they are marked.

According to the California MUTCD, crosswalk markings provide guidance for pedestrians who are crossing roadways by defining and delineating paths on approaches to and within signalized intersections, and on approaches to other intersections where traffic stops. Crosswalk markings also serve to alert road users of a pedestrian crossing point across roadways not controlled by highway traffic signals or STOP signs. At non-intersection locations, crosswalk markings legally establish the crosswalk.



As noted in the FHWA report “Safety Effects of Marked Versus Unmarked Crosswalks at Uncontrolled Locations,” the California MUTCD does not provide specific guidance relative to the site condition (e.g., traffic volume, pedestrian volume, number of lanes, presence or type of median) where marked crosswalks should or should not be used at uncontrolled locations. Nor does the MUTCD give specific guidance on the application of crosswalk enhancement features such as high-visibility striping, advanced warning signage, or flashing beacons. While the California MUTCD allows the use of these devices, decisions on their specific applicability to a given location have historically been left to the judgment of the local traffic engineers. This section summarizes the various types of crosswalk-related markings, signage and enhancement treatments available for use in Stanislaus, discusses policies and procedures already in use for implementation of some of these devices, and provides more specific guidance and recommendations to assist Town traffic engineers with future implementation.

Crosswalk Markings

Marked crosswalks (**Table B-3**) serve to alert road users to expect crossing pedestrians and to direct pedestrians to desirable crossing locations. There are two different marking styles for pedestrian crosswalks in Stanislaus County: the standard “transverse” style, consisting of two parallel lines; and the “ladder” style consisting of the two parallel lines with perpendicular ladder bars striped across the width of the crosswalk.

Crosswalks should extend across the full width of intersections, or to the edge of the intersecting crosswalk, to encourage pedestrians to cross perpendicular to the flow of traffic. Crosswalk markings can be applied with paint, thermoplastic, or reflective thermoplastic tape. At controlled crosswalk locations (STOP signs or traffic signals), crosswalk markings by themselves are considered sufficient treatment, given the presence of a traffic control to stop vehicles. At uncontrolled crosswalk locations (either uncontrolled intersections or mid-block locations), marked crosswalks can be enhanced with crosswalk signage, advance warning signage, in-pavement flashers, or flashing beacons -- these additional crosswalk enhancements are discussed in more detail below.

Table B-3: Crosswalk Markings

Style	Sample
<p>Standard – Two solid white lines, 12 to 24 inches wide, spaced at least 6 feet apart (refer to CA MUTCD Sec. 3B.17). Also called “transverse.”</p>	
<p>Ladder – Adds cross bar “rungs” to the standard crosswalk marking described above. Width of ladder lines should be 1 foot, with minimum spacing of ladder lines 1-5 feet.</p>	
<p>School Crosswalks. Crosswalks within the designated school zone must be painted yellow, per California MUTCD. Can be marked either standard or ladder. The school zone can be set a distance up to 500 feet from the school boundary.</p>	

The decision on whether to install standard or ladder crosswalk markings depends upon a variety of factors such as the number of pedestrians crossing, traffic speeds/volumes, number of lanes to cross, presence of nearby schools or senior centers, and history of collisions. In general, standard transverse markings are considered appropriate at controlled intersections, minor uncontrolled intersections, and other crossing locations with low traffic volumes/speeds, short crossing distance, and good visibility. High visibility ladder markings are generally applied at uncontrolled or mid-block locations, especially on major streets with high pedestrian volumes, heavy traffic volumes and speeds, and more than one lane each direction.

Crosswalk Striping at Major Intersections

Crosswalks should be striped with transverse lines at all controlled intersection legs, at minimum. At major intersections, where pedestrian activity is high or where significant pedestrian-vehicle conflicts occur or visibility of the crosswalk is a concern, ladder or zebra style crosswalks should be used.

Crosswalk Striping at “T” Intersections or Offset Intersections of Major Arterials and Residential Streets

Stanislaus County has locations where major arterials intersect one or more minor residential streets on only one side, forming a “T” shaped intersection or a series of offset intersections. At locations where STOP or traffic signal controls are provided for each intersection leg, the provision of marked crosswalks should follow the guidelines for major intersections above. At locations where one or more intersection legs is uncontrolled, however, engineering judgment should be used in deciding whether or not to mark a crosswalk. Providing two marked crosswalks in close succession on an uncontrolled arterial roadway, for example, may reduce rather than enhance safety for pedestrians. In some locations, removing marked crosswalks on the inner portion of two offset intersection legs and enhancing the outer two marked crosswalks (through signage or traffic calming measure) may be the best solution, as shown in **Figure B-18**.

Wherever land uses adjacent to the major arterial of an offset or “T” intersection are expected to generate significant pedestrian traffic, at least one marked pedestrian crosswalk should be provided for each intersection. The decision to mark a crosswalk should be related to the presence of pedestrian-generating activity centers along a particular roadway; in some locations it is necessary to provide frequent marked pedestrian crosswalks, while in others it may be appropriate to space marked crosswalks further apart.

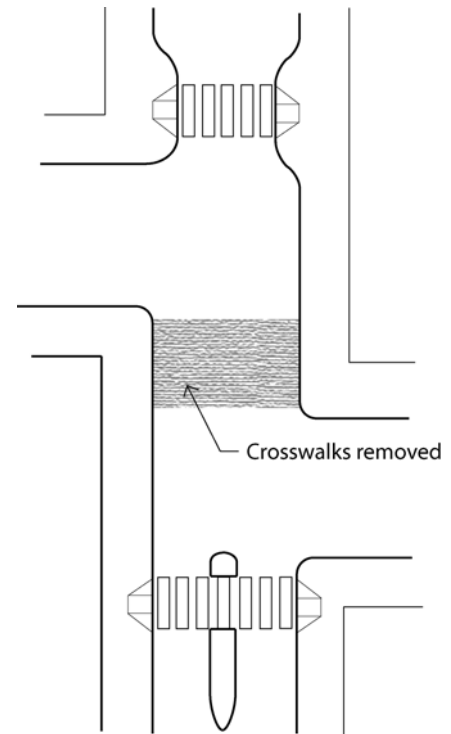

Source: Portland Pedestrian Design Guide

Figure B-18: Offset Intersection

Crosswalk Striping at Minor Intersections

At minor intersections, the use of standard transverse lines to mark the crosswalk is generally appropriate. Crosswalks should be aligned with curb ramps such that wheelchair users do not need to leave the crosswalk to access the sidewalk on either side of the roadway. Crosswalks should only be marked at uncontrolled locations following an appropriate engineering study.



Figure B-19: School Zone Crosswalk

Crosswalk Markings in School Zones

To alert drivers to the presence of a school, crosswalks within the designated school zone must be striped yellow rather than white. A school zone can be designated up to 500’ in advance of the school boundary. Special signage should also be located near school crossings in accordance with the guidelines provided in Chapter 7 of the California MUTCD. This document provide guidelines for enhancing crossings where one of the major concerns is the presence of school-aged children

Crosswalk Warning Signage and Pavement Markings

The California MUTCD provides guidance on the installation of warning signage and pavement stencils at and in advance of uncontrolled crosswalks. These signs are only for use at uncontrolled locations, because at STOP, YIELD, or signalized locations the presence of the traffic control serves to regulate the crosswalk at those intersections. Signage and stencils to supplement crosswalks are not required, and in fact the California MUTCD notes that such signs should be installed in locations where crossing activity is unexpected or not readily apparent.

In advance of the crosswalk, the Pedestrian Crossing sign plate is installed (W11-2). At the crosswalk location itself, the Pedestrian Crossing sign plate plus a downward arrow is installed to show the exact location of the crosswalk. White “PED XING” pavement markings may be placed in each approach lane to a marked crosswalk, except at intersections controlled by traffic signals or STOP or YIELD signs.

Special signage is required at and in advance of school crosswalks, also describe in the California MUTCD. Unlike the crosswalk warning signage for a normal (white) crosswalk, school crosswalk signage is mandatory. At each yellow school crosswalk, the School Crosswalk Warning Assembly B shall be installed, consisting of a School Warning plate (S1-1) plus downward arrow. In advance of each yellow school crossing, a School Advance Warning Assembly D shall be used, consisting of a school crossing plate plus “AHEAD.” Yellow “SLOW SCHOOL XING” markings can be used in advance of uncontrolled school crosswalks, placed at least 100 feet in advance of the crosswalks.



Figure B-20:
Pedestrian Warning Signage

High Visibility Signage

One way of increasing the visibility of pedestrian-related signage is through the use of a Fluorescent Yellow-Green (FYG) background. Use of this FYG signage is approved by the California MUTCD for use on pedestrian, bicycle and school signs. When the FYG background is used for corridor or school-area signing, a systematic approach should be used, so that the mixing of standard yellow and fluorescent yellow-green is avoided.



Figure B-22: High Visibility Signage

Stop and Yield Lines

The use of Stop Lines (commonly referred to as limit lines or stop bars) and Yield Lines is guided by California MUTCD Sec. 3B.16. Stop lines are solid white lines 12 inches to 24 inches wide that indicate where traffic must stop at STOP-controlled or signalized locations. Stop lines are only required at controlled locations where no marked crosswalk exists; where a crosswalk is present, the crosswalk itself can function as the stop line. Jurisdictions are permitted by the MUTCD to install a stop line in advance of a marked crosswalk if they desire. Installing stop lines in advance of crosswalks can help to discourage vehicle encroachment into the marked crosswalk, particularly in right-turn-on-red situations where vehicles often creep forward to get better visibility. One solution to this problem is to stripe a stop line on the left lanes farther back than the right lanes, allowing better visibility to the left for right-turning vehicles. This also allows more clearance for vehicles turning from perpendicular streets. A supplement to Stop Lines is

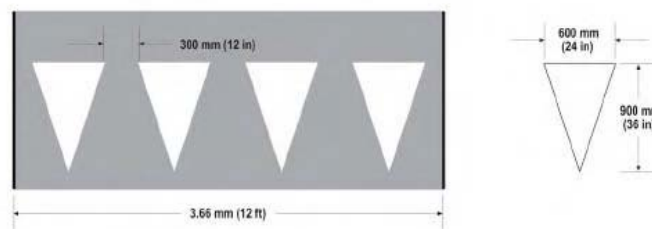

Figure B-23: Yield Line Specifications

“STOP HERE ON RED” signage with a down arrow indicating the stop line as the proper location for vehicles to stop in advance of the intersection.

Yield lines (also called yield teeth or shark’s teeth) indicate the point at which traffic should yield at uncontrolled locations, and are composed of white triangles 3 feet high by 2 feet wide, spaced 1 foot apart, as shown in Figure 11.

In California, vehicles are required to “YIELD” to pedestrians in uncontrolled crosswalks, and yield lines can be used to indicate the appropriate location for vehicles to stop in advance of an uncontrolled crossing location. These markings are most effective in mid-block locations, where there is no intersection to give a motorist cues on the location to wait for a crossing pedestrian. The California MUTCD notes that yield line placement should be 20 to 50 feet back of uncontrolled mid-block intersections. On multi-lane roadways, yield lines can be used to counter the “multiple-threat” collision, which refers to the situation where a car in one lane stops and screens the pedestrian from the view of the adjacent lane. Installing yield lines 40-50 feet back (two car lengths) gives both pedestrians and motorists a better view of each other during the crossing. “YIELD HERE FOR PEDESTRIANS” signs with a down arrow can be used at the yield lines to indicate the proper location for vehicles to yield in advance of the crosswalk.

It is recommended that the County encourage the installation of stop lines at least 4 feet back from the crosswalk at locations that have a history of vehicle encroachment into the crosswalk or vehicles failing to stop for pedestrians on right-turn-on-red. At signalized mid-block pedestrian crosswalks, the County should encourage the installation of stop lines at least 40 feet in advance of the signal indication. Where applicable, at uncontrolled mid-block crosswalk locations the county should encourage the installation of yield lines at least 40 feet in advance of the crosswalk.

Pedestrian Warning Signage for Signalized Intersections

As noted under the discussion of crosswalk signs and markings, crosswalk warning signs are not permitted at crosswalks controlled by a traffic signal, as the traffic control itself serves to regulate vehicles at the intersection. At signalized intersections, particularly where right turn on red is permitted, installing stop lines as described above may be one way of reducing encroachment of vehicles into the pedestrian crosswalk. Another solution to remind drivers who are making turns to yield to pedestrians is installation of a “TURNING TRAFFIC MUST YIELD TO PEDESTRIANS” (R10-15) sign.

In-Street Yield to Pedestrian Signs

In-Street Yield to Pedestrian Signs are flexible plastic signs installed in the median to enhance a crosswalk at uncontrolled crossing locations. These signs communicate variations of the basic message ‘State Law: Yield to Pedestrians’. The signs can be supplemented with a “SCHOOL” plate at the top for use at school crosswalks. If used near schools, these signs are sometimes installed on a portable base and brought out in the morning and back in at the end of each day by school staff, which may reduce the chance that the sign will become less visible to motorists by being left out all the time. For permanently installed signs, maintenance can be an issue as the signs may be run over by vehicles and need to be replaced occasionally. Installing the signs in a raised median can help extend their lifetime.



Figure B-24: Yield to Pedestrian Signs

Flashing Beacons

Where the visibility of a crosswalk is poor, or where warranted by safety considerations, yellow flashing beacons can be installed to alert motorists to expect crossing pedestrians. Beacons can either be mounted on posts on the side of the roadway, or installed on mast arms over the roadway. Beacons can be installed in conjunction with any crosswalk warning sign, and can be set to operate at all times where the level of pedestrian activity along a corridor warrants. When installed at a specific crosswalk location, beacons can be set to be activated by pedestrians to only flash during the crossing time.

When used to make motorists aware of school zones, flashing beacons should be timed to flash only during the morning and afternoon school commute hours when children are present.

Special Crosswalk Pavement Treatments

For aesthetic reasons, crosswalks are sometimes constructed with distinctive paving materials such as colored pavement or special decorative pavers meant to look like brick. Brick should never be used in crosswalks, as it tends to wear down quickly, becoming uneven and slippery and causing difficulties for pedestrians, especially persons with disabilities. Any use of unique materials or colored pavement should use concrete pavers or asphalt, and textures should maintain a smooth travel surface and good traction. It is important to note that these decorative pavement treatments do not enhance the visibility of the crosswalk location, in many cases make the crossing more difficult for persons with disabilities to navigate, make the crosswalk less visible to motorists at night, and for these reasons are not recommended. Regardless of any colored or unique pavement treatment used, marked crosswalk locations should always be marked with parallel transverse lines.

In-Roadway Warning Lights

The California MUTCD has approved the use of in-roadway warning lights at uncontrolled marked crosswalks. Also known as in-pavement flashing crosswalks, illuminated crosswalks, or “Santa Rosa lights,” these yellow lights embedded just above the roadway surface and flash when activated (either by a pushbutton or by passive detection) by a crossing pedestrian. The California MUTCD Sec. 4L.02 provides guidance on evaluating the need for in-roadway warning lights and offers standards for their placement. Stanislaus currently has no in-roadway warning lights installed.



Figure B-25: In-Roadway Warning Lights

Engineering Treatments for Crosswalks

Curb Extensions

Curb extensions, also called “bulbouts” to describe their shape, are engineering improvements intended to reduce pedestrian crossing distance and increase visibility. Curb extensions can either be placed at corners or at mid-block crosswalk locations, and generally extend out about 6 feet to align with the edge of the parking lane. In addition to shortening the crosswalk distance, curb extensions serve to increase pedestrian visibility by allowing pedestrians to safely step out to the edge of the parking lane where they can see into the street, also making them more visible to oncoming drivers. At corners, curb extensions serve to reduce the turning radius, and provide space for perpendicularly-aligned curb ramps. Where bus stops are located, bulbouts can provide additional space for passenger queuing and loading.

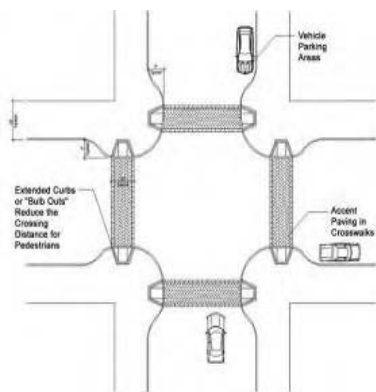

Figure B-26: Curb Extensions

Despite their advantages, curb extensions can require major re-engineering of the street and are not appropriate for all situations. Installing curb extensions where there are existing storm drain catch basins can require costly drainage modifications. Curb extensions may not be possible in some locations due to existing driveways or bus pull-out areas. Curb extensions need to be designed to avoid conflict with bicycle facilities, and should never extend into a bicycle lane.

Given their relatively high cost and challenges of implementation, curb extensions are not recommended as a tool for widespread implementation along every street. Each potential curb extension location must be evaluated on a case-by-case basis, taking into account factors such as crossing volumes, parking lane widths, infrastructure challenges such as drainage or driveways, and locations of bus stops.

Median Refuge Islands

On wide, multi-lane roadways, pedestrians can benefit from median refuge islands, which offer a place to wait after crossing only half of the street. Refuge islands increase the visibility of pedestrian crossings, and decrease pedestrian collisions by reducing pedestrian/vehicle conflicts, motor vehicle speeds, and exposure time for pedestrians.² They also allow pedestrians to consider cross traffic from one direction at a time, making it easier to find a gap and simplifying crossing.

The MUTCD defines an island as an area between traffic lanes for control of vehicular movements or for pedestrian refuge. Under the MUTCD definition, a refuge island can be delineated by curbs (raised), pavement markings (painted), or other devices. The MUTCD does not give any specific guidance on minimum dimensions of a refuge island.

The FHWA document “Pedestrian Accommodations at Intersections” advises that a refuge island should be a minimum of 4 feet wide and 12 feet long (or the width of the crosswalk, whichever is greater).³ The Metropolitan Transportation Commission’s Pedestrian Toolkit states that refuge islands should be a minimum of 4 feet wide and 8 feet long.⁴

The ADA Access Board’s Draft Guidelines on Accessible Public Rights of Way has a section on median islands.⁵ These guidelines have not yet been adopted, and as such are not ADA requirements at this time. However, the guidelines are under consideration for adoption in the future, and cities may wish to look at these guidelines as best practices for compliance with future ADA standards.

The following right-of-way guidelines are recommended by the Access Board’s Draft Guidelines⁶:

- Medians and pedestrian refuge islands in crosswalks shall contain a pedestrian access route, including passing space connecting to each crosswalk.
- Regarding a minimum width for refuge islands, the guidelines state that medians and pedestrian refuge islands shall be 1.8 m (6.0 ft) minimum in length in the direction of pedestrian travel.
- The guidelines permit both ramped up and cut-through design of refuge island, and advise that there are many factors to consider when deciding whether to ramp or cut-through a median or island. Those factors may include slope and cross slope of road, drainage, and width of median or island. They note that “curb ramps in medians and islands can add difficulty to the crossing for some users.”
- Medians and refuge islands are also required to have detectable warnings, with detectable warnings at cut-through islands separated by a 2-foot minimum length of walkway without detectable warnings.

For pedestrian refuge islands at intersections, installing a median nose can help to provide additional protection for pedestrians. Median noses can also reduce vehicles encroaching into the refuge area when making left turns. However, median noses may not be feasible to install due to turning movement restrictions they can cause from side streets. Neither the MUTCD nor the ADA Access Board Guidelines have any requirement for median noses to be installed at intersection refuge islands. Median nose installations should be considered on a case-by-case basis.

² FHWA 2002b, p. 72

³ Pedestrian Accommodation and Intersections, FHWA, http://safety.fhwa.dot.gov/ped_bike/univcourse/swless15.htm

⁴ MTC Safety Toolbox <http://www.mtc.ca.gov/planning/bicyclespedestrians/tools/pedRefugeIsland/index.htm>

⁵ <http://www.access-board.gov/PROWAC/draft.htm#305>

⁶ Access Board, Draft Accessibility Guidelines for Public Rights of Way, Section R305.4

Channelized Right-Turn Slip Lanes

A right turn slip lane, often delineated by paint or a concrete island, separates the right turn movement from through and left-turning vehicles, as shown in **Figure B-27**.

Slip turn lanes can be dangerous to pedestrians because drivers tend to concentrate on merging with oncoming traffic and may not see pedestrians entering the crosswalk. In high-traffic areas, inadequate gaps in right-turning traffic may exist, making crossing a slip turn lane difficult for pedestrians. The non-standard corner geometry introduced by slip lanes is extremely difficult for the blind to negotiate. Uncontrolled slip turn lanes should be discouraged where conflicts with pedestrians are anticipated.

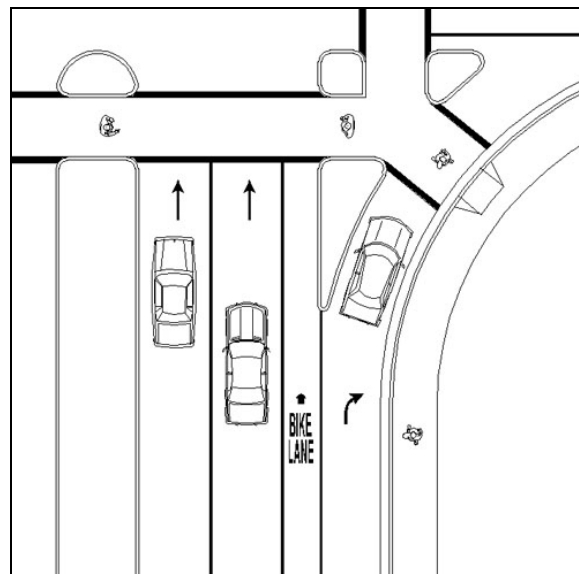

Source: Improving Pedestrian Access to Transit: An Advocacy Handbook

Figure B-27: Slip Turn Crossing Treatment

The closing of a slip turn lane solves the problems discussed above and also serves to shorten the pedestrian crossing distance.

Further, the area can be made an attractive corner for pedestrians through the use of street furniture, benches, and small-scale plantings. Where slip turns cannot be removed due to traffic capacity considerations, several options exist for enhancing pedestrian safety. Signalizing the right turn movement creates gaps for pedestrians and may be the safest alternative. Passive crossing treatments, such as warning signage, or a raised crosswalk connecting the sidewalk with a refuge island, may also improve conditions for pedestrians.

Slip turns should not be provided at intersections in which vehicles turn into a dedicated traffic lane. Because vehicles entering a dedicated lane do not have to yield to cross traffic, drivers tend to turn at higher speeds, making it difficult for pedestrians to cross safely.

Safety Barrels and Bollards

Safety barrels and bollards can be effective in preventing vehicles from entering the pedestrian right-of-way. They are also an inexpensive way to test more permanent intersection improvements such as curb bulbs. The placement of these vertical elements must ensure that they do not block the travel path of pedestrians, particularly those who are sight or mobility impaired. The creative use of bollards to create combination curb bulbs/bicycle parking areas can be effective in improving pedestrian safety while enhancing the aesthetic quality of an intersection and providing bicycle parking.

Multi-Use Trail Intersections

Multi-use trails provide pedestrian and bicycle travel ways that are separated from automobile traffic. Trail crossings must be safe for pedestrians and bicyclists alike, and should also provide convenient connections to the street network. In general, trail crossings should be treated just like other intersection types, oriented at 90 degree angles whenever possible ensuring safety for all trail and road users. In addition to typical intersection lighting, signage, and traffic control features, trail crossings should include design features that warn both trail and roadway users of the crossing. Restricting parking near trail crossings, as at typical intersections, enhances sight distance.

Traffic Signal Enhancements

This section discusses specific pedestrian enhancements for use at signalized intersection locations.

Countdown Pedestrian Signals

Countdown pedestrian signals provide information on the amount of time remaining in the pedestrian change interval, which can assist pedestrians in making safe crossing judgments. Guidance on the use of these devices is now included in the California MUTCD.



Figure B-28: Countdown Pedestrian Signals

Signal Timing

Traffic signal timing can have an effect on the ability of slower-moving pedestrians to safely cross the street. The length of the pedestrian clearance phase is determined by calculating a clearance interval, which is the length of time it takes a person to walk from the curb on one side to the center of the farthest travel lane on the other. The standard walking speed used to calculate pedestrian clearance intervals recommended by the California MUTCD is 4 feet per second. However, where there are populations of pedestrians who walk more slowly, a lower walking speed should be considered in determining the pedestrian clearance time. Particularly where there are seniors or persons with disabilities, the MUTCD recommends a walking speed of 2.8 feet per second. This recommendation may also be applied to locations are elementary schools, as and young children commonly walk more slowly. Where signalized crossings are in close proximity to locations such as senior centers, senior housing, elementary schools, or centers generating significant volume of pedestrians with disabilities, the County should consider encouraging the utilization of a walking speed of 2.8 ft/sec to allow for longer crossing times.

Signal Activation

Traffic signals in generally operate in one of three ways:

Fixed-time signals have a regular cycle of phases with a fixed amount of green time for each movement. There is a regular WALK phase in each direction for each cycle, and pedestrians are not required to push a button to actuate the WALK phase.

Fully-actuated signals are highly responsive to local traffic variations because they detect vehicles and pedestrians as they arrive in the intersection on any approach. On fully-actuated signals, pedestrians are required to push the button to actuate the WALK phase in any direction.

Semi-actuated signals employ vehicle and pedestrian detection only on the side or local street. A green light and WALK phase is on for the major street unless the presence of a pedestrian or car is detected on the local street. Pedestrians must push a button to actuate the side street signal.

Special pedestrian phases can also be used to provide more crossing time for pedestrians at certain intersections. These include:

- Extended phase – At intersections with an extended phase, pedestrians who push the pedestrian crossing button get more time to cross the street than is provided during the normal signal phase.
- Leading Pedestrian Interval (LPI) – At intersections where there are conflicts between turning vehicles and pedestrians, pedestrians are given a “walk” designation a few seconds before the associated green phase for the intersection begins.

Table B-4: Pedestrian Signal Actuation

Pedestrian Signal Actuation	
	<p>There are several simple design considerations for pedestrian signals at signalized intersections:</p> <ul style="list-style-type: none"> • In areas with high pedestrian use (or high pedestrian volume), use a pedestrian signal sequence instead of an actuated signal. • Alternatively, install countdown pedestrian signals. This communicates to the pedestrian when the signal is about to change. • Place pedestrian push-buttons in a clear location on the sidewalk and clearly in line with the pedestrian crossing. Pedestrians push all buttons to ensure the signal changes for all directions. • Place additional actuators prior to the intersection to allow pedestrians to push buttons before they reach the corner of the intersection. • Adjust the signal timing to accommodate the needs of pedestrians. This includes adjusting crossing times for intersections where pedestrians need to wait.
<p>Accessible Pedestrian Signals – Verbal/Vibrotactile Tone</p>	<p>When verbal messages are used to communicate the walk interval is in effect, the verbal message shall be the term "walk sign," which means the walk interval is in effect.</p> <p>A verbal message is not required at times when the walk interval is in effect:</p> <ol style="list-style-type: none"> 1. It shall be the term "wait." 2. It need not be repeated for the duration of the walk interval. <p>Source: MUTCD</p> <p>Accessible pedestrian signals that provide verbal messages may provide similar messages in languages other than English, if needed, except for the terms "walk sign" and "wait." A vibrotactile pedestrian device communicates information about pedestrian timing through a vibrating surface by touch.</p> <p>Vibrotactile pedestrian devices, where used, shall indicate that the walk interval is in effect, and for which direction it applies, through the use of a vibrating directional arrow or some other means.</p>

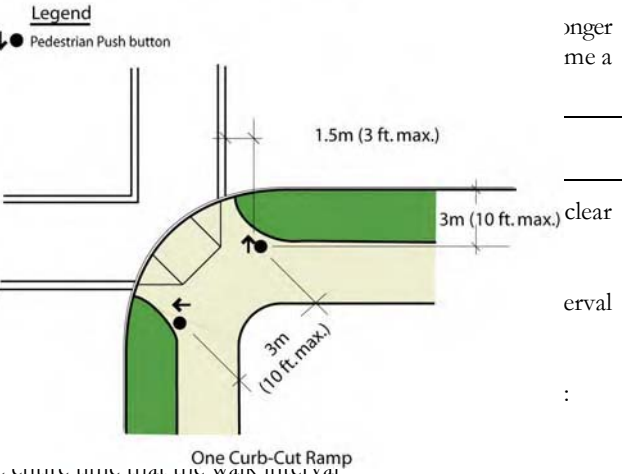
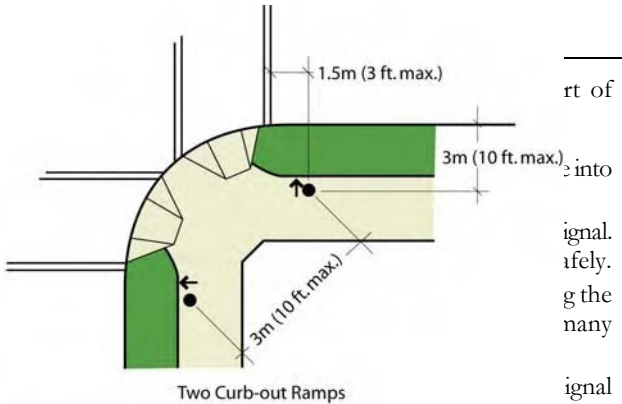

Figure B-29: Recommended Pushbutton Locations

Pedestrian Pushbutton Detectors

Pedestrian pushbutton detectors allow for actuation of pedestrian signals, and should be located at all intersection corners where pedestrian actuation is used. As required by the California MUTCD, pedestrian pushbutton detectors must be accompanied by signs explaining their use. Pedestrian pushbutton detectors should be easily accessible for those in wheelchairs and for the sight-impaired, located approximately 3.5 ft. off the ground on a level surface. Pedestrian pushbuttons should not be used in locations where the pedestrian phase is set on a fixed cycle and cannot be actuated. One exception to this is the use of pushbuttons to activate audible pedestrian signals at non-actuated locations.

Curb Ramps

According to ADA regulations, all streets with sidewalks and curbs or other barriers must have curb ramps at intersections (U.S. Access Board 1999, p. 58). San Benito County requires curb ramp installation at all street intersections. New curb ramps must comply with the requirements of the State of California Code of Regulations Title 24 and the Americans with Disabilities Act Accessibility Guidelines.

Curb ramps should be oriented to direct pedestrians to the opposite corner and to provide a direct connection between the sidewalk through passage zone and the crosswalk. Curb ramps should be designed such that wheelchair users can transition from the sidewalk to the crosswalk without having to enter travel lanes. Diagonal corner curb ramps are sometimes an acceptable alternative for retrofits. However, signalized intersections on arterial streets should have one curb ramp per marked crosswalk at each corner.

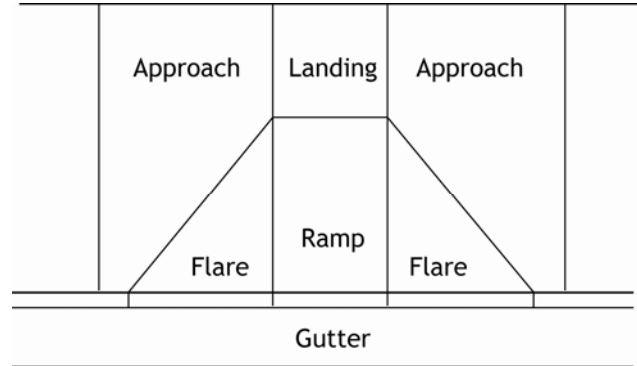

Figure B-30: Curb Ramp Components

Curb ramps consist of the following basic components, described in Table A-4 and depicted in **Figure C-30**.

Table B-5: Curb Ramp Components

Landing	The level area at the top of a curb ramp facing the ramp path. Landings allow wheelchairs to enter and exit a curb ramp, as well as travel along with sidewalk without tipping or tilting.
Approach	The portion of the sidewalk on either side of the landing. Approaches provide space for wheelchairs to prepare to enter landings.
Flare	The sloped transition between the curb and sidewalk. Flares provide a sloped transition between the sidewalk and curb ramp to help to prevent pedestrians from tripping over an abrupt change in level.
Ramp	The sloped transition between the sidewalk and street where the grade is constant and cross slope at a minimum. Ramps are the main pathway between the sidewalk and street.
Gutter	The trough that runs between the curb or curb ramp and the street, designed to serve as a conduit for storm water flow or other drainage.

Recommended Curb Ramp Guidelines

Curb ramps are necessary for people who use wheelchairs to access sidewalks and crosswalks. They help people with other mobility impairments to transition easily between sidewalks and crosswalks. Curb ramps also help people with strollers or rolling carts. ADA requires installation of curb ramps in new sidewalks, as well as retrofitting of existing sidewalks. The three most common curb ramp designs, perpendicular, parallel, and diagonal, and the situations in which each should be used, are described below. Other curb ramp types, including built-up ramps and depressed corners, are also addressed. **Table B-6** provides a summary of accessible curb ramp design standards.

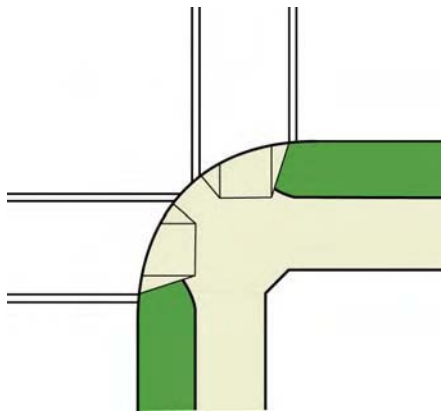

Figure B-31: Perpendicular Curb Ramp Design

Perpendicular Curb Ramps

Perpendicular curb ramps allow for a convenient, direct path of travel with a 90-degree angle to the curb. Perpendicular curb ramps are oriented such that users enter the street traveling perpendicular to vehicular traffic. Perpendicular curb ramps maximize access for pedestrians at intersections. They reduce the overall distance required to cross the street when compared with diagonal ramps. However, perpendicular curb ramps require more space than single diagonal ramps.

Perpendicular curb ramps without level landings are difficult for wheelchairs to negotiate, and should not be installed. Where sidewalks are narrow, there may not be space for two perpendicular curb ramps and their landings. Adding curb extensions can create additional space to accommodate two perpendicular ramps and landing areas. All newly constructed sidewalks should include two perpendicular ramps at each corner. Retrofitted ramps in multi-

family neighborhoods and commercial areas should include perpendicular ramps, except where space is inadequate.

Diagonal Curb Ramps

Diagonal curb ramps are usually similar in design to perpendicular curb ramps, but are placed at the apex of the corner and oriented such that users enter the street traveling diagonally to the path of vehicle travel. Diagonal curb ramps require less space than dual perpendicular curb ramps, but also require users to take a longer, circuitous travel path to the other side than a perpendicular ramp. They cause the user to travel towards the center of the intersection before maneuvering left or right to cross the street. This is undesirable, particularly at locations with tight turning radii and no on-street parking, because users are exposed to turning vehicles at the base of the ramp. Being in the intersection longer exposes the user to greater risk of being hit by vehicles.

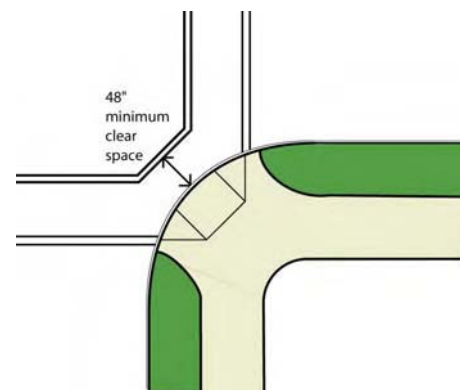
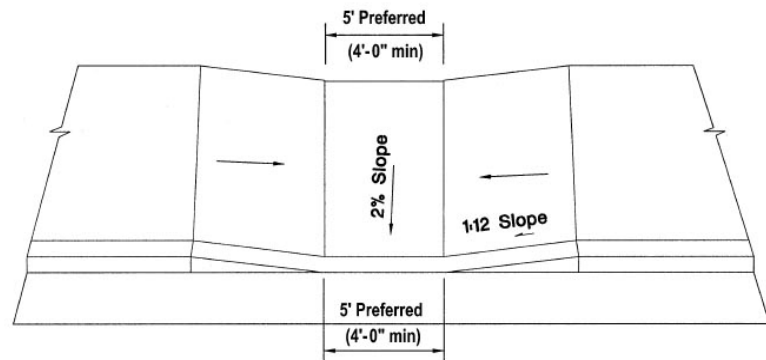

Figure B-32: Diagonal Curb Ramp Design

Diagonal curb ramps cost less than perpendicular ramps since they are single ramps, and hence more diagonal curb ramps can be installed than perpendicular curb ramps thereby speeding up retrofit programs. Diagonal curb ramps are generally desirable only on streets with little motor vehicle traffic where the advantage of installing more curb ramps compensates for the drawbacks, or in locations where perpendicular curb ramps cannot be accommodated due to space constraints.

Parallel Curb Ramps

Parallel curb ramps are two opposing ramps that slope down parallel to the direction of pedestrian travel. They are generally used on narrow sidewalks where inadequate space exists to install other ramp types. Parallel curb ramps can be useful in location with high curbs, as the ramps can be extended to ensure a gentle ramp grade without concern for right-of-way limitations. However, parallel curb ramps require pedestrians who are continuing along the sidewalk to ramp down and up. Where space exists in a planting strip, parallel curb ramps can be designed in combination with perpendicular ramps to reduce the ramping for through pedestrians.



Source: Georgia Pedestrian Facilities Guidebook

Figure B-33: Parallel Curb Ramp Design

Depressed Corners

Depressed corners gradually lower the level of the sidewalk through a slope that meets the grade of the street. Depressed corners offer the same advantages of perpendicular curb ramps. However, they are generally not recommended since they make it difficult for people who are visually and cognitively impaired to distinguish the transition from the sidewalk and street. They can confuse guide dogs as well. Turning motor vehicles, especially large trucks, may also intrude onto depressed corners. For these reasons, where depressed corners exist, they should be retrofitted with bollards or other intermittent barriers to prevent cars from traveling on the sidewalk. Detectable warnings should also be placed at the edge of the sidewalk.

Table B-6: Comparison of Minimum Curb Ramp Dimensions

Curb Ramp Type	Characteristic	ADAAG Standards	US Access Board Guidelines	Title 24 Standards	Other
Perpendicular Diagonal	Maximum slope of ramps	8.33%; if space prohibits this, 8.33% to 10% with a maximum rise of 150 mm (6 in); or 10% to 12.5% with a maximum rise of 75 mm (3 in)	7.1% + or - 1.2%		
	Maximum cross-slope of ramps	2%			
	Maximum slope of flared sides	10%			
	Minimum ramp width	0.915 m (36 in)	1.22 m (48 in)	1.22 m (48 in)	
	Minimum landing length	0.915 m (36 in); if landing is less than 1.22 m (48 in)			
	Minimum landing width		1.22 m (48 in)		
	Maximum gutter slope			5%	Gutter should be designed to not retain water
	Changes in level			flush	
	Truncated domes			610 mm (24 in)	
	Maximum slope of ramps	8.33%; if space prohibits this, 8.33% to 10% with a maximum rise of 150 mm (6 in); or 10% to 12.5% with a maximum rise of 75 mm (3 in)			
Maximum cross-slope of ramps	2%				

Table B-6: Comparison of Minimum Curb Ramp Dimensions

Curb Ramp Type	Characteristic	ADAAG Standards	US Access Board Guidelines	Title 24 Standards	Other
	Maximum slope of flared sides	10%			
	Minimum ramp width	0.915 m (36 in)	1.22 m (48 in)	1.22 m (48 in)	
	Minimum landing length	0.915 m (36 in); if landing is less than 1.22 m (48 in)			
	Minimum landing width		1.22 m (48 in)		
	Maximum gutter slope		2%		Gutter should be designed to not retain water
	Changes in level		none		
	Minimum clear space			1.22 m (48 in)	
Parallel and combination	Maximum slope of ramps	8.33%; if space prohibits this, 8.33% to 10% with a maximum rise of 150 mm (6 in); or 10% to 12.5% with a maximum rise of 75 mm (3 in)	7.1%		
	Maximum cross-slope of ramps	2%			
	Maximum slope of flared sides	10%			
	Minimum ramp width	0.915 m (36 in)	1.22 m (48 in)	1.22 m (48 in)	
	Minimum landing length	0.915 m (36 in); if landing is less than 1.22 m (48 in)			
	Minimum landing width		1.22 m (48 in)		
	Maximum landing slope		2%		
	Maximum gutter slope		5%		Gutter should be designed to not retain water
	Changes in level		none		
	Truncated domes (parallel); detectable warnings (combination)			610 mm (24 in)	
Curb extensions and built-up curb ramps	Maximum slope of ramps	8.33%; if space prohibits this, 8.33% to 10% with a maximum rise of 150 mm (6 in); or 10% to 12.5% with a maximum rise of 75 mm (3 in)	7.1% + or - 1.2% (curb ext.); 7.1% (built-up)		
	Maximum cross-slope of ramps	2%	2% + or - 0.9% (curb ext.); 2% (built-up)		
	Maximum slope of flared sides	10%			
	Minimum ramp width	0.915 m (36 in)	1.22 m (48 in)	1.22 m (48 in)	
	Minimum landing length	0.915 m (36 in); if landing is less than 1.22 m (48 in)			
	Minimum landing width		1.22 m (48 in)		
	Maximum gutter slope		5%		Gutter should be designed to not retain water
	Changes in level		flush (curb ext.); none (built-up)		
Detectable warnings			610 mm (24 in)		

Raised Sidewalks

The purpose of these facilities is to eliminate grade changes from the pedestrian path and give pedestrians greater prominence as they cross the street.

When implementing these measures:

- Use detectable warnings at the curb edges to alert vision-impaired pedestrians that they are entering the roadway.
- Approaches to the raised crosswalk may be designed to be similar to speed humps.



Figure B-34: Raise Crosswalk

Turning Radius

A corner's turning radius determines how fast a driver can comfortably make a turn. A tighter turn or shorter radius forces drivers to slow down allowing them to see pedestrians better and stop more quickly. Intersection corners with short radii increase safety for pedestrians at intersections by creating more sidewalk space and less roadway space. A decreased curb radius also allows for curb ramps that are aligned parallel to crosswalks. A 10' turning radius is recommended for streets without curbside parking. For streets with curbside parking, a 20' radius is recommended. Streets with significant volumes of truck traffic should be analyzed and may require larger corner radii.

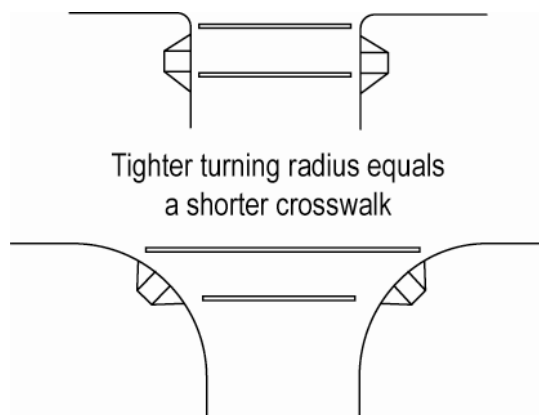

Figure B-35: Turning Radius



The arterial and collector roadway system the County is designed to facilitate the flow of traffic. Many roadway intersections are designed using a wide turn or longer radius to allow vehicles to make the transition from one roadway to another without a substantial reduction in speed. The existing engineering standards used should be adjusted as land development and local planning code will allow in order to provide a safer environment for pedestrians.

Traffic Calming



Traffic calming interventions slow traffic by modifying the physical environment of a street. A variety of traffic calming measures (**Table B-7**) are available including speed humps, chokers, traffic circles and both full and partial street closures. In addition, speed limit reductions may be effective, with or without physical traffic calming improvements at reducing speeds.

Research into the efficacy of traffic calming devices to improve pedestrian safety has shown that traffic calming can reduce the number of automobile collisions. A Vancouver study published in 1997 showed an average collision reduction of 40% in four neighborhoods that used a combination of the traffic calming types described below.⁷

Table B-7: Traffic Calming Measures

Traffic Calming Measure	Description	Considerations for Use
Street Trees		
	<p>In addition to their aesthetic value, street trees can slow traffic and improve safety for pedestrians. Trees add visual interest to streets and narrow the street's visual corridor, which may cause drivers to slow down.</p>	<ul style="list-style-type: none"> • If the sidewalk corridor is not wide enough to accommodate street trees, adding tree plantings in the parking lane is possible, knowing that these trees have shortened life spans. • The placement of plantings should consider potential for conflict with street sweeping and drainage.
Raised Crosswalks		
	<p>Raised crosswalks are similar to speed humps, but are installed at intersections to elevate crosswalks. Raised sidewalks eliminate grade changes from the pedestrian path and give pedestrians greater prominence as they cross the street.</p>	<ul style="list-style-type: none"> • Use detectable warnings at the curb edges to alert vision-impaired pedestrians that they are entering the roadway. • May be designed so they do not have a slowing effect (for example, on emergency response routes).
Chicanes		
	<p>Chicanes are a series of curb extensions or narrowings that create an S-shaped route, causing traffic to slow down. An example of chicanes can be found on Milvia Street in North Berkeley, pictured at left.</p>	<ul style="list-style-type: none"> • With no major pedestrian issues, chicanes can provide additional landscaping and street buffer area. Care should be taken to ensure that chicanes do not affect bicycle mobility along streets proposed for chicanes.

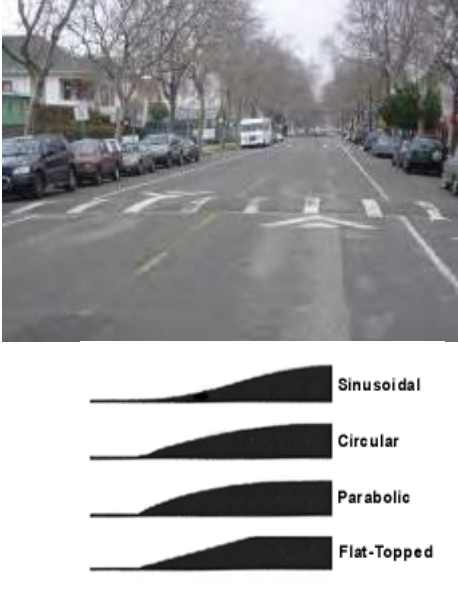
⁷ Zein, S. R.; Geddes, E.; Hemsing, S.; Johnson, M., "Safety Benefits of Traffic Calming," Transportation Research Record Vol: #1578 pp. 3-10

Speed Humps		
	<p>Speed humps are elevated, sloped sections of pavement that require drivers to slow down as they pass over.</p> <p>Speed humps are generally 12-22 feet long and 3-4 inches high. There are four speed hump shapes – sinusoidal, circular, parabolic and flat-topped – which differ in the shape of their slope. The sinusoidal shaped are much smoother to drive over at the intended speed, and are also more friendly to bicyclists. (Many older speed humps are of the parabolic shape, which provides a more pronounced bump when driving over them.)</p>	<ul style="list-style-type: none"> • Not recommended for use on emergency response routes or transit corridors.
Traffic Calming Circles		
	<p>Traffic calming circles are circular islands in the middle of an intersection. Traffic circles slow traffic by altering the route of vehicles and by reducing the distance a driver can see down the street, which also causes traffic to slow.</p> <p>Traffic circles can either be two-way or four-way stop or yield.</p>	<ul style="list-style-type: none"> • Unlike full roundabouts, traffic circles maintain the crosswalks at the intersection corners. • However, in some cases it was necessary to move the crosswalks back to accommodate the turning radius of larger vehicles around the circle. In these cases the crosswalks are no longer aligned directly perpendicular with that corner, which could cause difficulty for persons with visual impairments • Care should be taken to ensure that any landscaping in the circles uses low-growing shrubs that maintain visibility for pedestrians, particularly those in wheelchairs.

This page intentionally left blank

Appendix C: Sample Bicycle Parking Code

This appendix provides sample bicycle parking planning and event permit code language taken from the City of Oakland Municipal Code. It is recommended that the County of San Benito pass and encourage its cities to include similar language in their code. The City of Oakland provides detailed parking requirements per building square footage, and includes provisions such as employee shower requirements in large commercial buildings. Also included and recommended are bicycle parking requirements for large events.

Planning Code Bicycle Parking Requirements

Chapter 17.117 BICYCLE PARKING REQUIREMENTS

Article I. General Provisions

- 17.117.010 Title, Purpose, and Applicability.
- 17.117.020 Bicycle Parking Required for New and Existing Uses.
- 17.117.030 More than One Activity on a Lot.
- 17.117.040 Determination by Director of City Planning.

Article II. Standards for Required Bicycle Parking

- 17.117.050 Types of Required Bicycle Parking.
- 17.117.060 Minimum Specifications for Required Bicycle Parking.
- 17.117.070 Location and Design of Required Bicycle Parking.

Article III. Minimum Number of Required Bicycle Parking Spaces

- 17.117.080 Calculation Rules.
- 17.117.090 Required Bicycle Parking – Residential Activities.
- 17.117.100 Required Bicycle Parking – Civic Activities.
- 17.117.110 Required Bicycle Parking – Commercial Activities.
- 17.117.120 Required Bicycle Parking – Manufacturing and All Other Activities.
- 17.117.130 Required Shower and Locker Facilities – All Activities.
- 17.117.140 Additional Considerations for Variance Determination.
- 17.117.150 Automobile Parking Credit.

Article I. General Provisions

- 17.117.010 Title, Purpose, and Applicability.

The provisions of this chapter shall be known as the bicycle parking requirements. The purpose of these regulations is to require secure and adequate long term-and-short term parking for bicycles, thereby promoting alternative transportation, providing additional, more sustainable transportation choices for residents and commuters, and reducing traffic congestion and air pollution. These requirements shall apply to the indicated activities as specified hereinafter.

- 17.117.020 Bicycle Parking Required for New and Existing Uses.

- A. Bicycle Parking Shall be Provided for New Facilities and Additions to Existing Facilities. Bicycle parking as prescribed hereafter shall be provided for activities occupying facilities, or portions thereof, which are constructed, established, wholly reconstructed, or moved onto a new lot after the effective date of the bicycle parking requirements, or of a subsequent rezoning or other amendment thereto establishing or increasing bicycle parking for such activities, except to the extent that existing bicycle parking exceeds such requirements for any existing facilities. The required amount of new bicycle parking shall be based on the cumulative increase in floor area, or other applicable unit of measurement prescribed hereafter, after said effective date.
- B. Bicycle Parking Shall be Provided for Remodels. “Remodel” means any proposed physical improvement of an existing structure which requires a building permit but does not include New Facilities or Additions to Existing Facilities.

1. Remodel projects that are over 10,000 s.f. and have an estimated construction cost, excluding seismic retrofit costs, greater than \$250,000 shall provide the number of short-term bicycle parking spaces prescribed in Sections 117.090 to 117.120. This amount shall be adjusted to account for changes in the Building Cost Index for the San Francisco Bay Region, as reported in the Engineering News Record. The adjustment shall be made annually, starting in 2009, no sooner than one year from adoption.
 2. Remodel projects that are over 50,000 s.f. and have an estimated construction cost, excluding seismic retrofit costs, over \$1,000,000 shall provide, in addition to short-term bicycle parking, the number of long-term bicycle parking spaces and shower and locker facilities prescribed in Sections 117.090 to 117.130. This amount shall be adjusted to account for changes in the Building Cost Index for the San Francisco Bay Region, as reported in the Engineering News Record. The adjustment shall be made annually, starting in 2009, no sooner than one year from adoption.
- C. Bicycle Parking Shall be Provided for New Living Units in Existing Facilities. If any facility, or portion thereof, which is in existence on the effective date of the bicycle parking requirements, or of a subsequent rezoning or other amendment thereto establishing or increasing bicycle parking requirements for an activity therein, is altered or changed in occupancy so as to result in an increase on the number of residential living units therein, bicycle parking as prescribed hereafter shall be provided for the new units. However, such bicycle parking need be provided only in the amount by which the requirement prescribed hereafter for the facility after said alteration or change exceeds the requirement prescribed hereafter for the facility as it existed prior to such alteration or change; and such new bicycle parking need not be provided to the extent that existing bicycle parking exceeds the latter requirement.

17.117.030 More than One Activity on a Lot.

Whenever a single lot contains different activities with the same bicycle requirement, the overall requirement shall be based on the sum of all such activities, and the minimum size prescribed hereafter for which any bicycle parking is required shall be deemed to be exceeded for all such activities if it is exceeded by their sum. Whenever a single lot contains activities with different bicycle parking requirements, the overall requirement shall be the sum of the requirements for each activity calculated separately; provided, however, that the minimum size prescribed hereafter for which any bicycle parking is required shall be deemed to be exceeded on said lot for all activities for which the same or a smaller minimum size, expressed in the same unit of measurement, is prescribed, if said minimum size is exceeded by the sum of all such activities on the lot.

17.117.040 Determination by Director of City Planning.

In the case of activities for which the Director of City Planning is required to prescribe a number of bicycle parking spaces or for which this chapter is not clear or does not prescribe a number of spaces, the Director of City Planning shall base his or her written determination on the number of employees, residents or customers and the nature of operations conducted on the site. Any such written determination shall be subject to appeal pursuant to the administrative appeal procedure in Chapter 17.132.

Article II. Standards for Required Bicycle Parking.

17.117.050 Types of Required Bicycle Parking.

- A. Long-term Bicycle Parking.
Each long-term bicycle parking space shall consist of a locker or locked enclosure providing protection for each bicycle from theft, vandalism and weather. Long-term bicycle parking is meant to accommodate employees, students, residents, commuters, and others expected to park more than two hours.
- B. Short-term Bicycle Parking.
Short-term bicycle parking shall consist of a bicycle rack or racks and is meant to accommodate visitors, customers, messengers, and others expected to park not more than two hours.

17.117.060 Minimum Specification for Required Bicycle Parking.

- A. All bicycle parking facilities shall be dedicated for the exclusive use of bicycle parking.
- B. All required short-term bicycle parking spaces shall permit the locking of the bicycle frame and one wheel with a U-type lock, support the bicycle in a stable position without damage to wheels, frame, or components, and provide two points of contact with the bicycle's frame.

- C. All required long-term bicycle parking spaces, with the exception of bicycle lockers, shall permit the locking of the bicycle frame and one wheel with a U-type lock and support the bicycle in a stable position without damage to wheels, frame, or components.
- D. Bicycle parking facilities shall be securely anchored so they cannot be easily removed and shall be of sufficient strength and design to resist vandalism and theft.
- E. The overall design and spacing of such facilities shall meet the standards of Section 17.117.070 or as may be modified.

17.117.070 Location and Design of Required Bicycle Parking.

Required bicycle parking shall be placed on site(s) as set forth below:

- A. A bicycle parking space shall be at least two and a half (2.5) feet in width by six (6) feet in length to allow sufficient space between parked bicycles.
- B. An encroachment permit may be required from the City to install bicycle parking in the public right-of-way.
- C. Bicycle parking facilities shall not impede pedestrian or vehicular circulation.
 - a. Bicycle parking racks located on sidewalks should maintain a minimum of five and one half (5.5) feet of unobstructed pedestrian right-of-way outside the bicycle parking space. For sidewalks with heavy pedestrian traffic, at least seven (7) feet of unobstructed right-of-way is required.
- D. Bicycle parking facilities are subject to the following standards:
 - a. Racks shall be located with at least thirty (30) inches in all directions from any vertical obstruction, including but not limited to other racks, walls, and landscaping. General Food Sales and Large Scale Combined Retail and Grocery Sales Activities are encouraged to locate racks with a thirty-six (36) inch clearance in all directions from any vertical obstruction, including but not limited to other racks, walls, and landscaping.
 - b. A minimum four (4) foot wide aisle of unobstructed space behind all required bicycle parking shall be provided to allow for adequate bicycle maneuvering.
- E. Bicycle parking facilities within auto parking facilities shall be protected from damage by cars by a physical barrier such as curbs, wheel stops, poles, bollards, or other similar features capable of preventing automobiles from entering the bicycle facility.
- F. Bicycle parking facilities shall be located in highly visible well-lighted areas. In order to maximize security, whenever possible short-term bicycle parking facilities shall be located in areas highly visible from the street and from the interior of the building they serve (i.e. placed adjacent to windows).
- G. The location and design of required bicycle parking shall be of a quality, character and color that harmonize with adjoining land uses. Required bicycle parking shall be incorporated whenever possible into building design or street furniture.
- H. Long-term bicycle parking shall be covered and shall be located on site or within five hundred (500) feet of the main building entrance unless approved by the Director of City Planning with a written Discretionary Waiver. The main building entrance excludes garage entrances, trash room entrances, and other building entrances that are not publicly accessible.
- I. Discretionary Waiver. The long-term bicycle parking location requirement of five hundred (500) feet may be waived in writing by the Director of City Planning when said activities are located within one thousand (1000) feet of a proposed or existing bike station or similar high-capacity bicycle parking facility. Any determination on such waiver shall be subject to appeal pursuant to the administrative appeal procedure in Chapter 17.132.
- J. Whenever any required bicycle parking is proposed to be provided on a lot other than the lot containing the activity served, the owner or owners of both lots shall prepare and execute to the satisfaction of the City Attorney, and file with the Alameda County Recorder, an agreement guaranteeing that such facilities will be maintained and reserved for the activity served, for the duration of said activity.
- K. Short-term bicycle parking shall be placed within fifty (50) feet of the main entrance to the building or commercial use and should be in a well trafficked location visible from the entrance. When the main entrance fronts the sidewalk, the installer may obtain an encroachment permit from the City to install the bicycle parking in the public right-of-way. The main building entrance excludes garage entrances, trash room entrances, and other building entrances that are not publicly accessible.

17.117.080 Calculation Rules.

- A. If after calculating the number of required bicycle parking spaces a quotient is obtained containing a fraction of one-half or more, an additional space shall be required; if such fraction is less than one-half it may be disregarded.
- B. When the bicycle parking requirement is based on number of employees, the number of spaces shall be based on the number of working persons on the lot during the largest shift of the peak season. If the Director of City Planning determines that this number is difficult to verify for a specific facility, then the number of required long-term bicycle parking spaces shall be a minimum of two spaces or five percent of the amount of required automobile spaces for the proposed facility, whichever is greater.
- C. When the bicycle parking requirement is based on number of seats, in the case of pews or similar facilities each twenty (20) inches shall be counted as one seat.
- D. The calculation of short-term bicycle parking may include existing racks that are in the public right-of-way and are within 50 feet of the main entrance.

17.117.090 Required Bicycle Parking – Residential Activities.

Subject to the calculation rules set forth in Section 17.117.080, the following minimum amounts of bicycle parking are required for all Residential Activities and shall be developed and maintained pursuant to the provisions of Article II of this chapter:

Type of Activity	Long-term Bicycle Parking Requirement	Short-term Bicycle Parking Requirement
Permanent and Semi-Transient Residential Activities occupying the specified facilities:		
1) One-Family Dwelling.	No spaces required.	No spaces required.
2) One-Family Dwelling with Secondary Unit.	No spaces required.	No spaces required.
3) Two-Family Dwelling.	No spaces required.	No spaces required.
4) Multifamily Dwelling.		
a) With private garage for each unit.	No spaces required.	1 space for each 20 dwelling units. Minimum requirement is 2 spaces.
b) Without private garage for each unit.	1 space for each 4 dwelling units. Minimum requirement is 2 spaces.	1 space for each 20 dwelling units. Minimum requirement is 2 spaces.
c) Senior Housing.	1 space for each 10 dwelling units. Minimum requirement is 2 spaces.	1 space for each 20 dwelling units. Minimum requirement is 2 spaces.
5) Rooming House.	1 space for each 8 residents. Minimum requirement is 2 spaces.	No spaces required.
6) Mobile Home.	1 per 20 units.	No spaces required.
7) HBX Live/Work Lofts.	1 space for each 4 dwelling units. Minimum requirement is 2 spaces.	1 space for each 20 dwelling units. Minimum requirement is 2 spaces.
Residential Care, Service-Enriched Permanent, Transitional Housing, and Emergency Shelter Residential Activities occupying the specified facilities:		
8) Residential Care.	1 space for each 20 employees or 1 space for each 70,000 s.f., whichever is greater. Minimum requirement is 2 spaces.	2 spaces.
9) Service-Enriched Permanent Housing.		
10) Transitional Housing.	1 space for each 8 residents. Minimum requirement is 2 spaces.	1 space for each 20 dwelling units. Minimum requirement is 2 spaces.
11) Emergency Shelter Residential.	1 space for each 20 employees or 1 space for each 70,000 s.f., whichever is greater. Minimum requirement is 2 spaces.	1 space for each 5,000 s.f. of floor area. Minimum requirement is 2 spaces.

17.117.100 Required Bicycle Parking – Civic Activities.

Subject to the calculation rules set forth in Section 17.117.080, the following minimum amounts of bicycle parking are required for the specified Civic Activities and shall be developed and maintained pursuant to the provisions of Article II of this chapter:

Civic Activity	Long-term Bicycle Parking Requirement	Short-term Bicycle Parking Requirement
1) Essential Service. 2) Limited Childcare.	Number of spaces to be prescribed by the Director of City Planning, pursuant to Section 17.117.040.	Number of spaces to be prescribed by the Director of City Planning, pursuant to Section 17.117.040.
3) Community Assembly.		
a) Churches, temples, and synagogues.	1 space for each 40 fixed seats, or one space for each 4,000 s.f. of floor area, whichever is greater. Minimum requirement is 2 spaces.	1 space for each 40 fixed seats, or one space for each 2,000 s.f. of floor area, whichever is greater. Minimum requirement is 2 spaces.
b) Other.	Number of spaces to be prescribed by the Director of City Planning, pursuant to Section 17.117.040.	Number of spaces to be prescribed by the Director of City Planning, pursuant to Section 17.117.040.
4) Non-Assembly Cultural.	1 space for each 20 employees. Minimum requirement is 2 spaces.	Spaces for 2% of maximum expected daily attendance.
5) Administrative.	1 space for each 20 employees. Minimum requirement is 2 spaces.	1 space for each 20,000 s.f. of floor area. Minimum requirement is 2 spaces.
6) Health Care. 7) Special Health Care.	1 space for each 20 employees; or one space for each 70,000 s.f. of floor area, whichever is greater. Minimum requirement is 2 spaces.	1 space for each 40,000 s.f. of floor area. Minimum requirement is 2 spaces.
8) Utility and Vehicular.		
a) Communications equipment installations and exchanges, electrical substations, emergency hospitals operated by a public agency, gas substations, neighborhood newscarrrier distribution centers.	No spaces required.	No spaces required.
b) Fire Stations and Police Stations. c) Post offices, excluding major mail-processing centers.	1 space for each 10 employees. Minimum requirement is 2 spaces	6 spaces.
d) Publicly operated off-street parking lots and garages available to the general public without charge or on a fee basis.	No spaces required.	Minimum of 6 spaces or 1 per 20 auto spaces (parking lots excepted).
9) Community Education.		
a) Public, parochial, and private day-care centers for fifteen (15) or more children.	1 space for each 10 employees. Minimum requirement is 2 spaces.	1 space per each 20 students of planned capacity. Minimum requirement is 2 spaces.
b) Public, parochial, and private nursery schools and kindergartens.	1 space for each 10 employees. Minimum requirement is 2 spaces.	1 space per each 20 students of planned capacity. Minimum requirement is 2 spaces.
c) Public parochial and private elementary, junior high and high schools.	1 space for each 10 employees plus 1 space for each 20 students of planned capacity. Minimum is 2 spaces.	1 space per each 20 students of planned capacity. Minimum requirement is 2 spaces.
10) Extensive impact		
a) Colleges and universities.	1 space for each 10 employees plus 1 space for each 10 students of planned capacity; or 1 space for each 20,000 s.f. of floor area, whichever is greater.	1 space for each 10 students of planned capacity.
b) Railroad and bus terminals.	Spaces for 3.5% of projected maximum daily ridership.	Spaces for 1.5% of projected maximum daily ridership.

c) Other.	Number of spaces to be prescribed by the Director of City Planning, pursuant to Section 17.117.040.	Number of spaces to be prescribed by the Director of City Planning, pursuant to Section 17.117.040.
-----------	---	---

17.117.110 Required Bicycle Parking – Commercial Activities

Subject to the calculation rules set forth in Section 17.117.080, the following amounts of bicycle parking are required for the specified Commercial Activities and shall be developed and maintained pursuant to the provisions of Article II of this chapter:

Commercial Activity	Long-term Bicycle Parking Requirement	Short-term Bicycle Parking Requirement
Retail		
1. General Food Sales.	1 space for each 12,000 s.f. of floor area. Minimum requirement is 2 spaces.	1 space for each 2,000 s.f. of floor area. Minimum requirement is 2 spaces.
2. Convenience Market.	1 space for each 12,000 s.f. of floor area. Minimum requirement is 2 spaces.	1 space for each 5,000 s.f. of floor area. Minimum requirement is 2 spaces.
3. Fast-Food Restaurant.		
4. Alcoholic Beverage Sales.		
5. Convenience Sales and Service.		
6. Mechanical or Electronic Games.		
7. General Retail Sales.		
8. Large-scale combined retail and grocery sales.		
9. General Personal Service.		
10. Consumer Laundry and Repair Service.		
11. Check Cashier and Check Cashing.		
12. Retail Business Supply.		
13. General Wholesale Sales.		
14. Construction Sales and Service.		
Office		
1. Consultative and Financial Service.	1 space for each 10,000 s.f. of floor area. Minimum requirement is 2 spaces.	1 space for each 20,000 s.f. of floor area. Minimum requirement is 2 spaces.
2. Administrative Commercial.		
3. Business and Communication Service.		
Medical		
1. Medical Service.	1 space for each 12,000 s.f. of floor area. Minimum requirement is 2 spaces.	1 space for each 5,000 s.f. of floor area. Minimum requirement is 2 spaces.
2. Animal Care.		
Auto Related		
1. Automotive Sales, Rental, and Delivery.	1 space for each 12,000 s.f. of floor area. Minimum requirement is 2 spaces.	1 space for each 20,000 s.f. of floor area. Minimum requirement is 2 spaces.
2. Automotive Servicing.	1 space for each 20 employees.	No spaces required.
3. Automotive Repair and Cleaning.	Minimum requirement is 2 spaces.	
Other Commercial		
1. Group Assembly.	Number of spaces to be prescribed by the Director of City Planning pursuant to Section 17.117.040.	Number of spaces to be prescribed by the Director of City Planning pursuant to Section 17.117.040.
2. Research Service.	1 space for each 10,000 s.f. of floor area. Minimum requirement is 2 spaces.	1 space for each 40,000 s.f. of floor area. Minimum requirement is 2 spaces.
3. Transient Habitation.	1 space for each 20 rentable rooms. Minimum requirement is 2 spaces.	1 space for each 20 rentable rooms. Minimum requirement is 2 spaces.
4. Automotive Fee Parking.	1 space for each 20 automobile spaces. Minimum requirement is 2 spaces.	Minimum of 6 spaces or 1 per 20 auto spaces (parking lots excepted)
5. Transport and Warehousing.	1 space for each 40,000 s.f. of floor area. Minimum requirement is 2 spaces.	No spaces required.
6. Undertaking Service.	1 space for each 12,000 s.f. of floor area. Minimum requirement is 2 spaces.	2 spaces.

7. Scrap Operation.	1 space for each 20 employees. Minimum requirement is 2 spaces.	No spaces required.
8. HBX Work/Live.	1 space for each 4 dwelling units. Minimum requirement is 2 spaces.	1 space for each 20 dwelling units. Minimum requirement is 2 spaces.

17.117.120 Required Bicycle Parking – Manufacturing and Other Activities

Subject to the calculation rules set forth in Section 17.117.080, the following minimum amounts of bicycle parking are required for the specified Manufacturing, Agricultural and Extractive Activities and All Other Activities and shall be developed and maintained pursuant to the provisions of Article II of this chapter:

Type of Activity	Long-term Bicycle Parking Requirement	Short-term Bicycle Parking Requirement
Manufacturing and Production		
1. Custom Manufacturing. 2. Light Manufacturing. 3. General Manufacturing. 4. Heavy Manufacturing. 5. Small Scale Transfer and Storage. 6. Industrial Transfer/Storage Hazardous Waste Management. 7. Residual Repositories Hazardous Waste Management.	1 space for each 15,000 s.f. of floor area. Minimum requirement is 2 spaces.	No spaces required.
Agricultural and Extractive		
1. Plant Nursery Agricultural.	Number of spaces to be prescribed by the Director of City Planning pursuant to Section 17.117.040.	Number of spaces to be prescribed by the Director of City Planning pursuant to Section 17.117.040.
2. Crop and Animal Raising Agricultural 3. Mining and Quarrying Extractive.	No spaces required.	No spaces required.
Other Manufacturing		
1. HBX Work/Live.	1 space for each 4 dwelling units. Minimum requirement is 2 spaces.	1 space for each 20 dwelling units. Minimum requirement is 2 spaces.

17.117.130 Required Shower and Locker Facilities

Subject to the calculation rules set forth in Section 17.117.080, the following amounts of shower facilities and lockers are required per gender for the specified Activities and shall be developed and maintained pursuant to the provisions of Article II of this chapter:

Type of Activity	Shower Requirement (per gender)	Locker Requirement
Residential.	None required.	None required.
Civic.	None required.	None required.
Commercial: Less than 150,000 square feet of floor area.	None required.	None required.
Commercial: 150,000 square feet of floor area or greater.	A minimum of 2 showers per gender plus one shower per gender for each 150,000 s.f. above 150,000 s.f.	4 lockers per shower.
Manufacturing.	None required.	None required.
Agricultural and Extractive.	None required.	None required.

17.117.140 Additional Considerations for Variance Determination

A variance may be granted if the applicant can make the variance findings contained in Section 17.148.050. In making a variance determination, the following additional considerations should be taken into account:

1. The variance, if granted, will not be contrary to the policies included in the Bicycle Master Plan.
2. Consideration can be afforded to a proposal if incorporation of the bicycle parking would be detrimental to other bicycle or pedestrian facilities.

3. Consideration can be afforded to a proposal with a site access that is in excess of the street grade criteria established by the Bicycle Master Plan.
4. In consideration of what is physically feasible, the proposal meets as many of the bicycle parking requirements as possible to provide a form of storing bicycles in a safe, secure and accessible manner.

17.117.150 Automobile Parking Credit

The total number of required off-street automobile parking spaces may be reduced at the ratio of one automobile space for each six bicycle spaces provided in excess of the requirements in this chapter. The bicycle parking provided for this automobile parking credit shall include both long-term and short-term bicycle parking in proportion to the minimum long-term and short-term requirements for the given project. The total number of required off-street automobile parking spaces cannot be reduced by more than five percent.

Large Event Bicycle Parking Requirements

Chapter 9.52 SPECIAL EVENT PERMITS*

9.52.040 Definitions.

“Attended bicycle parking” means a service provided by the event sponsor or qualified bicycle parking service provider where at least one attendant is present throughout the event to receive, return and guard bicycles, and where a safe and sufficiently large area has been set aside for event attendees to leave their bicycles.

9.52.080 Conditional approval of permit.

J. Requiring the event promoter to provide attended bike parking service for events that expect 5,000 or more attendees, and for smaller events at the discretion of the Chief of Police. The promoter must advertise the service to potential attendees in all outreach and advertising materials and media, and place the bike parking area in an accessible location;

Grounds for denial of application.

O. The sponsor fails, or has failed in the past, to make provisions for attended bicycle parking, pursuant to Section 9.52.080; or

Appendix D: Sample Canal Use Agreement

This appendix provides a sample canal use agreement taken from the City of Modesto. It is recommended that agreements similar to the following be used to facilitate the development of the recommended facilities along irrigation canals included in this Plan.

License Agreement

This agreement is made in Modesto, Stanislaus County, on the _____ day of _____, 20XX, by and between the (Name of Irrigation District), an irrigation district organized and existing under the laws of the State of California, hereinafter called "District", and the City of Modesto, a municipal corporation, hereinafter called "Licensee".

This agreement is made with reference to the following facts and circumstances, among others:

- A. District has property interest in a strip of land _____ feet in width, with certain canal improvements thereon, which strip of land is commonly known and referred to as _____ Lateral No. ____ (hereinafter "Lateral No. ____").
- B. Licensee desires permission to use a portion of Lateral No. ____, along the northerly right-of-way from _____ Avenue to a point _____ feet west of _____ Avenue, as described in Exhibits "A-1, A-2, A-3, A-4" and shown on Exhibits "B-1, B-2, B-3, B-4", attached hereto and incorporated herein by this reference (hereinafter called "District's land"), for the purpose of installing and maintaining a bike path and landscaping and for a temporary construction area.
- C. District is now willing to grant such permission on the terms and conditions set forth herein.

NOW, THEREFORE, the parties hereto mutually agree as follows:

1. The District hereby grants the Licensee permission for Licensee to use District's land solely for the purpose of installing and maintaining a bike path, retaining wall and fence, trees, shrubs, vegetation and other landscape material, including irrigation system therefore (hereinafter called "Bike Path and Landscaping"). The Bike Path and Landscaping to be installed and maintained by Licensee shall conform to the plans and specifications attached hereto as Exhibit "E" and incorporated herein by this reference.
2. District also hereby grants to Licensee permission to use District's land for the purpose of a temporary construction area adjacent to the Bike Path and Landscaping area, as described in Exhibits "C-1, C-2, C-3, C-4" and shown in Exhibits "D-1, D-2, D-3, D-4" attached hereto. These temporary easements shall be used only for the purpose of and only for the period during initial construction of the Bike Path and Landscaping.
3. No trees, shrubs, vegetation or other landscape material which will exceed thirty (30) feet in height above ground level at maturity shall be placed within District's land. In the event that any such trees, shrubs, vegetation or other landscape material exceeds said height limitation or should encroach upon the canal bank roadway adjacent to the Lateral No. ____ at any time, Licensee shall, within thirty (30) days of its receipt of written notice from the District, trim or remove such Landscaping. If Licensee fails to adequately trim or remove such Landscaping within such thirty (30) day period, or such longer period as the parties may agree, the District may trim or remove such Landscaping at Licensee's risk and expense.
4. Except as specifically provided for in this Agreement, no alteration, improvement, installation, construction or use shall be made or permitted by Licensee in, under, along, across, upon or in respect to District's land without prior written consent of District.

5. This Agreement grants or creates a bare license only and not a license coupled with an interest. This Agreement does not grant or create an easement, nor does it convey or transfer to Licensee any right, title, or interest in or to any property of District. The license granted herein is non-exclusive. All rights granted hereunder, are subject and subordinate to all uses and purposes District may now or in the future make the District's and or Lateral No. _____. Licensee shall have no license, right or privilege with respect to District's land or Lateral No. ____ other than permission and privileges specifically and expressly granted by this Agreement.
6. Licensee shall not impair the access by District to any of its property or facilities by persons or machines for the purposes of construction, maintenance or operation of its properties or facilities.
7. Licensee shall not use or cause District's land to be used in any manner that will interfere with, be inconsistent with, or jeopardize the safety of, any use or purpose of the District.
8. In the event District shall at anytime so require for District's use or protection of its properties or facilities, Licensee, at Licensee's expense, shall alter, relocate or cease use of the Bike Path and Landscaping, or portions thereof, within thirty (30) days of receipt of written notice to Licensee.
9. All Use by Licensee of District's land, including the construction, placement, inspection, maintenance, replacement and use of the Bike Path and Landscaping, shall comply with all applicable federal, state and local laws, regulations, statutes, ordinances and codes, including, without limitation, applicable Occupational Safety and Health Acts and rules and regulations promulgated to implement such Acts, and all orders and decrees of bodies or tribunals having any jurisdiction or authority over the work to be performed under this Agreement (collectively, "laws").
10. District may at its sole discretion and at Licensee's sole expense remove or alter the Bike Path and Landscaping, or any portion or portions thereof, or any item placed or used within District's land, in violation of any provision of this Agreement. Said right to remove or alter shall not impose any duty or obligation on the District to do so.
11. Prior to excavation by Licensee within District's land, whether at the time of installation of the Bike Path and Landscaping or during subsequent periods or instances of maintenance, Licensee or its Contractor shall contact District and the Underground Service Alert (U.S.A – 1-800-642-2444) for the purpose of determining the location of underground facilities, equipment and other improvements. Locating all underground improvements shall be Licensee's sole responsibility.
12.
 - (a) Licensee shall not use, generate, manufacture, store or dispose of on, under or about Lateral No. ____, or transport to, from or across Lateral No. ____, any explosive or radioactive material, toxic substance, hazardous waste, hazardous material, hazardous substance, or the equivalent, as those terms may now or in the future be defined by common practice or by any federal, state, or local statute, ordinance or regulation or any governmental body or agency (hereinafter "Hazardous Substance").
 - (b) Without limiting any remedies District may have, in the event any disposal, release, discharge or spill of a Hazardous Substance or other contamination occurs on Lateral No. ____ as a result of Licensee's use of District's land, except such spills or contamination to the extent directly caused by the sole negligence or willful misconduct of District, Licensee shall immediately notify District and take all action to mitigate the effects of such disposal, release, discharge, spill or contamination. Licensee shall at Licensee's own expense, unless otherwise directed by District, remedy such disposal, release, discharge, spill or contamination to the District's satisfaction and in compliance with all applicable laws, rules and regulations. District shall have the option to perform the remediation itself or through any contractor and Licensee shall cooperate with District to complete the remediation and shall reimburse District for all costs and expenses incurred in connection with the remediation.
 - (c) In the event Licensee observes any material Licensee believes or has reason to believe may be Hazardous Substance or encounters any unknown physical condition of any unusual nature on Lateral

No. ____, other than disposals, releases, discharges, spills or contamination covered in (b), Licensee shall, without disturbing the condition, immediately cease all use of District's land and notify District. District shall investigate the condition and take any clean-up or other remedial action District deems necessary in its sole discretion.

- (d) In the event District or its contractor elects to perform remediation work, Licensee shall upon notice from District, cease use of District's land as directed in the notice. Such notice shall be given at least thirty (30) days in advance of the time at which Licensee shall cease its use of District's land; provided that the period of notice provided in this paragraph may be reduced in the event of an emergency or exigent circumstances necessitating such lesser notice, provided that in such cases District shall give as much notice as practical under the circumstances. District will notify Licensee when the condition has been resolved, at which time, but not before, Licensee may resume its use of District's land.
- (e) Licensee agrees to assume liability for and to defend and hold harmless District from and against all injuries or death to any person and damage to any property, and all related expenses, including without limitation attorney's fees, investigators' fees, administrative charges, litigation expenses and any judgments, fines, penalties or other charges assessed against District, resulting from Licensee's failure to comply with this Paragraph 12 and any laws, rules or regulations concerning the subject matter hereof. The provisions of this paragraph 12 shall survive the expiration and termination of this license.

13. Licensee shall not perform any work within District's land during any irrigation season which would interfere with the delivery of irrigation water. The parties hereto are mindful of the fact that District's irrigation season ordinarily, but not necessarily, ends mid-October and begins mid-March the following year.

14. Except as otherwise set forth herein, between Licensee and District, the Bike Path and Landscaping shall be the property of Licensee and Licensee shall have the sole responsibility and liability for said Bike Path and Landscaping. Licensee shall at all times maintain, at its own cost and expense, the Bike Path and Landscaping and all associated facilities. Licensee agrees to assume the sole and exclusive risk for damage to property or injury or death to any persons, arising from, or in any way related to Licensee's maintenance or failure to maintain the Bike Path and Landscaping. District shall have no duty or obligation to maintain the Bike Path and Landscaping.

15. If Licensee's exercise of rights under this Agreement, including the construction, use or maintenance of the Bike Path and Landscaping, or any portion thereof, causes damage, injury, impairment or degradation to District's land, the Lateral No. ____, or any other property or facility of District, Licensee shall, at its sole cost and expense, repair said damage, injury or degradation within thirty (30) days of receipt of written notice by District. Any such repair shall be performed in a timely manner and shall be in strict accordance with plans acceptable to District.

16. The District reserves unto itself the right to travel on, over and across the Bike Path and Landscaping for all District purposes. District also reserves the right to take any action at its discretion it deems necessary for its operations and facilities. District will coordinate with Licensee to the extent practicable when District intends to avail itself of such rights in a manner that will cause damage to the Bike Path and Landscaping. In any event District shall not be responsible for any damages, injury, impairment, or degradation to the Bike Path or Landscaping or for returning the Bike Path and Landscaping to any prior condition.

17. Licensee shall defend, indemnify and hold District, its directors, officers, agents and employees, and each of them harmless from and against any and all claims, losses, damages and liabilities arising from any act, omission or negligence of Licensee or Licensee's contractors, agents, or employees, or any of them, or arising from any accident, injury, or damage whatsoever caused to any person or property occurring in the exercise of, or in any manner connected directly or indirectly with, the license granted by this Agreement and from and against all costs, including court costs and attorney's fees, expenses and liabilities incurred in or in connection with, any such claim or proceeding brought thereon.

18. Licensee shall promptly pay District, on demand, full money compensation for any damages to any of District's property or facilities caused by, or in any manner connected directly or indirectly with, the exercise of the license or any rights granted by this Agreement.

19. District shall not be liable to Licensee and Licensee hereby waives and releases District from any and all claims it may now or at any time in the future have against District for any injury or death of any person or damage to any property, including the Bike Path and Landscaping and associated facilities, that may result to any person or property arising from or in any way connected with exercise of rights granted by this Agreement.

20. District acknowledges that Licensee has self-insured its financial obligations imposed by this Agreement; provided, however, that in the event Licensee at any time reduces its General Liability self insured retention amount below one million dollars, Licensee, at its sole cost and expense, and without limiting any of its other obligations or liabilities, shall obtain and maintain in effect at all times during the performance of the work under this Agreement, coverages and limits of liability insurance reasonably satisfactory to the District, each of which shall be maintained with insurers and under forms of policies reasonably satisfactory to the District and shall include the District as an additional insured.

21. District makes no representation as to, and does not warrant, the condition of District's land either at the inception of this Agreement or as to any future point in time. Nothing in this Agreement shall be construed as creating or imposing upon District any duty or obligation to maintain or repair Lateral No. ___ or District's land.

22. This Agreement is made solely for the benefit of Licensee and it is not made for the benefit of any person, firm, association, corporation or public entity not a party hereto and no person, firm, association, corporation or public entity other than Licensee shall have any right to enforce this Agreement.

23. The terms and provisions of this Agreement shall inure to the benefit of and bind each party's respective successors in interest and assigns; provided, however that neither party shall assign its rights or obligations hereunder without the prior written consent of the other party.

24. It is expressly understood and agreed that this Agreement shall operate to give Licensee the rights herein provided for only insofar as District may do so under and by virtue of the rights that District has in that portion of the Lateral No. ___ property to which this Agreement applies.

25. This Agreement contains all the agreements of the parties hereto and cannot be amended or modified except by a written agreement executed by the parties.

26. In the event that the license granted herein is no longer used by Licensee for permitted purposes, or the Agreement is otherwise terminated in accordance with the terms of this Agreement, Licensee at its expense, shall restore District's land to its original condition or to a condition acceptable to the District, and shall take such other closure action as is reasonably requested by the District. If Licensee fails to comply with the requirements of this Paragraph, District may undertake and complete such removal and restoration at the sole cost and expense of Licensee. Upon the occurrence of any of the above listed events, all rights granted to Licensee hereunder shall terminate.

27. Either party may terminate this license at any time by giving the other party at least ninety (90) days prior written notice.

28. If any of Licensee's privileges or duties are to be exercised or performed by any independent contractor or contractors, Licensee shall, effectively and appropriately, bind such contractor or contractors, contractually to the duties and obligations of Licensee hereunder. In that connection, Licensee shall among other requirements, require said contractor and contractors, to provide the required insurance and to indemnify and hold District harmless from and against any and all claims, damages, loss, liability and expenses, including court costs and attorney's fees, arising out of or on account of, any injury to or death of any person or person, or damage to property of any kind whatsoever and to whomsoever belonging, arising out of, in any manner directly or

indirectly connected with, said contract or contractors acts or omission in exercising Licensee's privileges or performing Licensee's duties created by this Agreement.

IN WITNESS WHEREOF, the parties hereto have caused this Agreement to be executed in duplicate on the day and year first above written.

AGREEMENT CONSENTING TO COMMON USE

This Agreement Consenting to Common Use is made on _____, 2006, by and between the (Name of Irrigation District), an irrigation district, hereinafter referred to as "District," and the City of Modesto, a municipal corporation, hereinafter referred to as "City."

This Agreement is made with reference to the following facts:

- A. The District is the owner in possession of certain real property within the City of Modesto consisting of a strip of land with certain improvements thereon, which real property is commonly known as and referred to as District's Lateral No. ____, hereinafter referred to as "Lateral ____."
- B. City desires, at City's expense, to install pedestrian walkway and bike path facilities along District's Lateral ____ for the purpose of its Virginia Corridor Community Project, and to make such improvements to the District's Lateral ____ as are necessary to maintain Lateral ____ in light of the installation of the new pedestrian walkway and bike path facilities (collectively, the "Facility Installation").
- C. The new Facility Installation will occupy a portion of District's right-of-way of its Lateral ____, which portion is hereinafter referred to as the "Area of Common Use", as described in Exhibit "A-5" and shown in Exhibit "B-5" attached hereto.

Now, therefore, IT IS AGREED as follows:

1. District, pursuant to the terms and conditions hereinafter set forth, hereby consents to the City's construction of the Facility Installation within the Area of Common Use. The Facility Installation shall be located within the Area of Common Use as set forth on Exhibits A and B, attached hereto. The facilities to be installed and maintained under this Agreement shall conform to the plans and specifications attached hereto as Exhibit "E" and incorporated herein by this reference.
2. District hereby grants to City a Temporary Construction Easement at each end of the Area of Common Use, as described in Exhibit "C-5" and shown in Exhibit "D-5" attached hereto. These temporary easements shall be used only for the purpose of and only for the period during initial construction of the new Facility Installation.
3. City acknowledges District's title to District's property and facilities situated at Lateral 4 within the Area of Common Use. District has and maintains the right to make full use of District's property and facilities in the Area of Common Use without need for any further permit or permission from City.
4. Except as specifically provided for in this Agreement, no alteration, improvement, installation, construction or use shall be made or permitted by City in, under, along, across, upon or in respect to the Area of Common Use or any other property or facility of District, without the prior written consent of District. City shall have no license, right or privilege with respect to the Area of Common Use, or any other property or facility of District, other than the permission and privileges expressly granted by this Agreement.
5. The construction of the Facility Installation consented to in Paragraph 1 of this Agreement shall be in compliance with the provisions of this Agreement and shall be coordinated with District's Water and Electric Operations Divisions.

6. City shall obtain District's approval of any and all facilities, construction plans and schedules, including the names and telephone numbers of the contractors, inspectors and the project manager, for making improvements within the Area of Common Use prior to commencement of any work within the Area of Common Use; provided however, that such approval shall not be unreasonably withheld. District may, at its discretion, but is not required to, inspect any and all work performed by City, or City's employees, agents or contractors, in the Area of Common Use. District's rights hereunder to inspect and approve, shall not impose any duty or obligation on District, nor shall such rights relieve City of the sole responsibility for the facilities, construction, plans, schedules and work, or relieve City of its contractual responsibilities hereunder.

7. City shall pay District for all reasonable time spent in reviewing plans, inspecting City's work performed in, along, under or near the Area of Common Use, or ensuring compliance of the terms and conditions of this Agreement. The amount charged shall not exceed the employees' weighted labor rate plus other costs actually incurred. Payment shall be made by City within thirty (30) days of submission of an invoice.

8. City shall not perform any work within the Area of Common Use during any irrigation season which would interfere with the delivery of irrigation water. The parties hereto are mindful of the fact that District's irrigation season ordinarily, but not necessarily, ends late October and begins the first of March of the following year.

9. Inasmuch as District's irrigation facilities within the Area of Common Use will have been changed by City pursuant to this Agreement, City agrees to maintain, repair or replace such irrigation facilities at City's expense in a timely manner as and when such maintenance, repair or replacement is necessary, unless such maintenance, repair or replacement is made necessary by negligent or wrongful acts of District, its agents, contractors or employees. In no event shall the City be liable for any betterment, changes or alterations in said facility made by or at the request of District for District's sole benefit.

10. Prior to any excavation by City within the Area of Common Use, whether at the time of construction of the Facility Installation or during subsequent periods or instances of maintenance, City or its contractor shall contact District and the Underground Service Alert (U.S.A. – 1-800-642-2444) for the purpose of determining the location of underground facilities, equipment and other improvements within said Area of Common Use. City shall be solely responsible for locating all underground improvements during construction and maintenance of the Facility Installation within the Area of Common Use.

11. Except as otherwise set forth herein, the Facility Installation shall, as between City and District, be the property of City and City shall have the sole responsibility and liability for said Facility Installation. City shall at all times maintain, at its own cost and expense, the Facility Installation. City agrees to assume the sole and exclusive risk for damage to property or injury or death to any persons, arising from, or in any way related to, the City's maintenance of or failure to maintain the Facility Installation. The District shall have no duty or obligation to maintain the Facility Installation

12. Except as expressly set forth herein, this Agreement shall not in any way alter, modify or terminate any of District's rights in its property or facilities. Both City and District shall use the Area of Common Use in such a manner as to not interfere unreasonably with the rights of other. Nothing herein contained shall be construed as a release or waiver of any claim for compensation or damages which District or City may now have, or may hereafter acquire, resulting from the construction of additional facilities or the alteration of facilities by either City or District in such a manner as to cause an unreasonable interference with the use of the Area of Common Use by the other.

13. Except in emergencies, District shall give reasonable notice to City before performing any work on District's property or facilities in the Area of Common Use. No additional permit will be required to do such work, provided, that in all cases, District shall make adequate provision for the protection of the traveling public when performing work on the District's property or facilities in the Area of Common Use.

14. If the construction, use or maintenance of the Facility Installation, or any portion thereof, causes damage, injury or degradation of the Area of Common Use, or District's property or facilities on or around the Area of Common Use, City shall, at its sole cost and expense, repair said damage, injury or degradation upon notice by

the District. Any such repair shall be performed in a timely manner and shall be in strict accordance with plans acceptable to the District.

15.

- (a) City shall defend, indemnify and hold District, its directors, officers, agents and employees, and each of them, harmless from and against any and all damages, losses, claims and liabilities arising from any act, omission or negligence of City or City's agents, contractors or employees, or any of them, or arising from any accident, injury, or damage whatsoever caused to any person or property, occurring in, or in any manner connected directly or indirectly with, the performance of this Agreement or the maintenance or use of the Facility Installation and from and against all costs, expenses, liabilities and attorneys' fees incurred in, or in connection with, any such claim or proceeding brought thereon.
- (b) City shall promptly pay District, on demand, full money compensation for any damage to any of District's property or facilities caused by, or in any manner connected directly or indirectly with, the performance of this Agreement or the maintenance or use of the Facility Installation.

16. In the event that District is required to relocate any District facilities in order for City to install, maintain or operate the Facility Installation, District shall, at City's sole expense, perform such relocation, provided, however, that no relocation of District facilities shall be performed until District receives and records appropriate easements, satisfactory to District, for District's relocated facilities.

17. City shall have the right to allow utility companies to install their facilities within the Area of Common Use, provided, however that any utility wishing to install their facilities within the Area of Common Use will be required to enter into an agreement permitting such installation with the District prior to the commencement of any work.

18. It is expressly understood and agreed that this Agreement shall operate to give City the rights herein provided for only insofar as District may do so under and by virtue of the rights that District has in that portion of District's Lateral 4 real property to which this Agreement applies. It is further expressly understood and agreed that this Agreement is made without representation or warranty of any kind.

19. District makes no representation as to, and does not warrant, the condition of its Lateral 4, either at the inception of this Agreement or as to any future point in time. Nothing in this Agreement shall be construed as creating or imposing upon District any duty or obligation to maintain or repair the Area of Common Use or the District's Lateral 4.

20. This Agreement is made solely for the benefit of City, and it is not made for the benefit of any person, firm, association, corporation or public entity not a party hereto, and no person, firm association, corporation or public entity other than city shall have any right to enforce this Agreement.

21. This Agreement contains all the agreements of the parties hereto and cannot be amended or modified except by a written agreement executed by the parties.

22. This Agreement shall inure to the benefit of and be binding upon the successors and assigns of both parties: provided, however that neither party shall assign its rights or obligations hereunder without the prior consent of the other party.

23. Time is of the essence of each provision of this Agreement.

24. All exhibits referred to in this Agreement are attached hereto and incorporated herein by reference.

25. In the event that the Area of Common Use is no longer used by City for the purposes agreed, City at its expense, shall remove City's improvements or take other closure action acceptable to District, and restore the Area of Common Use to its original condition or to a condition acceptable to the District. At such time as the

Area of Common Use is no longer used by City for the purposes agreed, all rights granted to City hereunder shall terminate.

26. If any of City's privileges or duties are to be exercised or performed by any independent contractor or contractors, City shall, effectively and appropriately, bind such contractor or contractors, contractually to the duties and obligations of City hereunder. In that connection, City shall among other requirements, require said contractor or contractors to maintain reasonable insurance coverage and to indemnify, defend and hold District harmless from and against any and all claims, damages, loss, liability and expenses, including court costs and attorney's fees, arising out of or on account of, any injury to or death of any person or persons, or damage to property of any kind whatsoever and to whosoever belonging, arising out of, in any manner directly or indirectly connected with, said contractors or contractors acts or omission in exercising City's privileges or performing City's duties created by the Agreement.

IN WITNESS WHEREOF, the parties hereto have caused this Agreement to be executed on the day and year first above written
